













Mikro-Scheren
Micro Scissors
Micro-Ciseaux
Micro-Tijeras
Микро-ножницы





| |  |  |
|----------------|---|---|
| | Blatt / Blade / лезвие 11 mm | |
| 12 cm / 4 3/4" | 03-1125-12 | 03-1127-12 |
| 15 cm / 6" | 03-1125-15 | 03-1127-15 |
| 18 cm / 7" | 03-1125-18 | 03-1127-81 |
| | Blatt / Blade / лезвие 15 mm | |
| 12 cm / 4 3/4" | 03-1135-12 | 03-1137-12 |
| 15 cm / 6" | 03-1135-15 | 03-1137-15 |
| 18 cm / 7" | 03-1135-18 | 03-1137-18 |

| |  |  |  |  |  |
|------------|---|---|---|---|--|
| | 25° | 45° | 60° | 90° | 125° |
| | Blatt / Blade / лезвие 11 mm | | | | |
| 18 cm / 7" | 03-1221-18 | 03-1223-18 | 03-1224-18 | 03-1226-18 | 03-1229-18 |
| | Blatt / Blade / лезвие 15 mm | | | | |
| 18 cm / 7" | 03-1121-18 | 03-1123-18 | 03-1124-18 | 03-1126-18 | 03-1129-18 |











| |  |  |  |  |  |
|------------|---|---|---|---|--|
| | 25° | 45° | 60° | 90° | 125° |
| | Blatt / Blade / лезвие 11 mm | | | | |
| 18 cm / 7" | 03-1231-18 | 03-1233-18 | 03-1234-18 | 03-1236-18 | 03-1239-18 |
| | Blatt / Blade / лезвие 14/15 mm | | | | |
| 18 cm / 7" | 03-1131-18 | 03-1133-18 | 03-1134-18 | 03-1136-18 | 03-1139-18 |

Mikro Scheren
Micro Scissors
Микро-ножницы



| CASTROVIEJO | | |
|-------------|---|--|
| |  |  |
| | Blatt / Blade / лезвие 9 mm | |
| 15 cm / 6" | 03-1604-15 | 03-1609-15 |
| 18 cm / 7" | 03-1604-18 | 03-1609-18 |
| | Blatt / Blade / лезвие 14 mm | |
| 15 cm / 6" | 03-1600-15 | 03-1605-15 |
| 18 cm / 7" | 03-1600-18 | 03-1605-18 |



| CASTROVIEJO | | | | | |
|-------------|---|---|---|---|---|
| |  |  |  |  |  |
| | 25° | 45° | 60° | 90° | 125° |
| | Blatt / Blade / лезвие 11 mm | | | | |
| 18 cm / 7" | 03-1621-18 | 03-1623-18 | 03-1624-18 | 03-1626-18 | 03-1629-18 |
| |  |  |  |  |  |
| | 25° | 45° | 60° | 90° | 125° |
| | Blatt / Blade / лезвие 11 mm | | | | |
| 18 cm / 7" | 03-1641-18 | 03-1643-18 | 03-1644-18 | 03-1646-18 | 03-1649-18 |





| STREAMLINE | | | | |
|----------------|--|-------------------|---|-------------------|
| | | | | |
| | Adventitia / Adventitia / адвентина | | Präparation / Dissection / диссекция | |
| | Blatt / Blade / лезвие 10 mm | | | |
| 15 cm / 6" | 03-1730-15 | 03-1735-15 | 03-1740-15 | 03-1745-15 |
| 18 cm / 7" | 03-1730-18 | 03-1735-18 | 03-1740-18 | 03-1745-18 |
| 21 cm / 8 1/4" | 03-1730-21 | 03-1735-21 | 03-1740-21 | 03-1745-21 |
| 23 cm / 9" | 03-1730-23 | 03-1735-23 | 03-1740-23 | 03-1745-23 |

| STREAMLINE | | | | | |
|------------|------------------------------|-------------------|-------------------|-------------------|-------------------|
| | | | | | |
| | 25° | 45° | 60° | 90° | 125° |
| | Blatt / Blade / лезвие 7 mm | | | | |
| 18 cm / 7" | 03-1711-18 | 03-1713-18 | 03-1714-18 | 03-1716-18 | 03-1719-18 |
| | Blatt / Blade / лезвие 10 mm | | | | |
| 18 cm / 7" | 03-1721-18 | 03-1723-18 | 03-1724-18 | 03-1726-18 | 03-1729-18 |



| STREAMLINE | | | | | |
|------------|------------------------------|-------------------|-------------------|-------------------|-------------------|
| | | | | | |
| | 25° | 45° | 60° | 90° | 125° |
| | Blatt / Blade / лезвие 10 mm | | | | |
| 18 cm / 7" | 03-1731-18 | 03-1733-18 | 03-1734-18 | 03-1736-18 | 03-1739-18 |

Mikro Scheren
Micro Scissors
Микро-ножницы







| YASARGIL - Streamline | | |
|-----------------------|--|--|
| |  |  |
| 23 cm / 9" | 03-1110-23 | 03-1115-23 |



| YASARGIL - Streamline | | |
|-----------------------|---|---|
| |  |  |
| | VANNAS-Blatt / Blade / лезвие | |
| 23 cm / 9" | 03-1112-23 | 03-1117-23 |



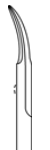





| YASARGIL | | |
|---|--|--|
| |  |  |
| | gerade/straight/ прямые | aufgebogen/curved up/ изогнутые вперед |
| Blatt / Blade / лезвие 27 mm | | |
| 16 cm / 6 1/4" | 03-1102-16 | 03-1103-16 |
| 18 cm / 7" | 03-1102-18 | 03-1103-18 |
| 20 cm / 8" | 03-1102-20 | 03-1103-20 |

| YASARGIL | | | |
|-------------------------------------|---|---|---|
| |  |  |  |
| | gerade/straight/ прямые | aufgebogen/curved up/ изогнутые вперед | zurückgebogen/curved down/ изогнутые назад |
| Blatt / Blade / лезвие 14 mm | | | |
| 16 cm / 6 1/4" | 03-1106-16 | 03-1107-16 | – |
| 20 cm / 8" | 03-1106-20 | 03-1107-20 | 03-1105-20 |





Mikro Scheren
Micro Scissors
Микро-ножницы



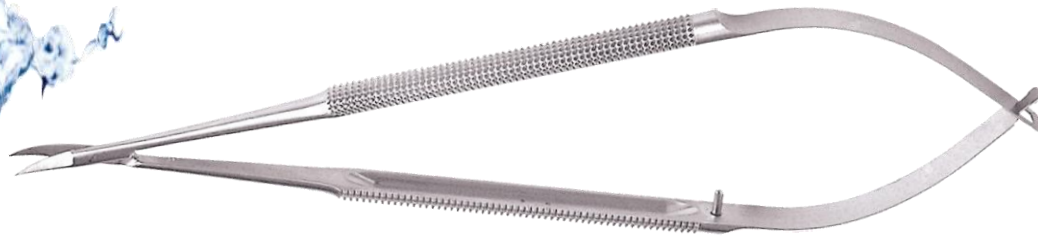









| YASARGIL | | |
|---|--|--|
| |  |  |
| | gerade/straight/ прямые | aufgebogen/curved up/ изогнутые вперед |
| Blatt / Blade / лезвие 27 mm | | |
| 23 cm / 9" | 03-1102-23 | 03-1103-23 |

| YASARGIL | | | | | |
|-------------------------------------|---|---|---|---|---|
| |  |  |  |  |  |
| | gerade/straight/ прямые | aufgebogen/curved up/ изогнутые вперед | zurückgebogen/curved down/ изогнутые назад | VANNAS | VANNAS aufgebogen/curved up/ изогнутые вперед |
| Blatt / Blade / лезвие 14 mm | | | | | |
| 23 cm / 9" | 03-1106-23 | 03-1107-23 | 03-1105-23 | 03-1108-23 | 03-1109-23 |







| |  |  |  |  |
|------------------|---|---|---|---|
| | Adventitia / Adventitia / адвентина | | Präparation / Dissection / диссекция | |
| | Blatt / Blade / лезвие 7mm | | | |
| 16,5 cm / 6 1/2" | 03-1881-16 | 03-1887-16 | 03-1891-16 | 03-1897-16 |
| | Blatt / Blade / лезвие 10mm | | | |
| 16,5 cm / 6 1/2" | 03-1882-16 | 03-1888-16 | 03-1892-16 | 03-1898-16 |
| | Blatt / Blade / лезвие 14mm | | | |
| 16,5 cm / 6 1/2" | 03-1883-16 | 03-1889-16 | 03-1893-16 | 03-1899-16 |

| |  |  |  |  |  |
|------------------|---|---|---|--|---|
| | 25° | 45° | 60° | 90° | 125° |
| | Blatt / Blade / лезвие 7 mm | | | | |
| 16,5 cm / 6 1/2" | 03-1506-16 | 03-1507-16 | 03-1508-16 | 03-1509-16 | 03-1510-16 |
| | Blatt / Blade / лезвие 10 mm | | | | |
| 16,5 cm / 6 1/2" | 03-1476-16 | 03-1477-16 | 03-1478-16 | 03-1479-16 | 03-1480-16 |
| | Blatt / Blade / лезвие 14 mm | | | | |
| 16,5 cm / 6 1/2" | 03-1482-16 | 03-1483-16 | 03-1484-16 | 03-1485-16 | 03-1486-16 |

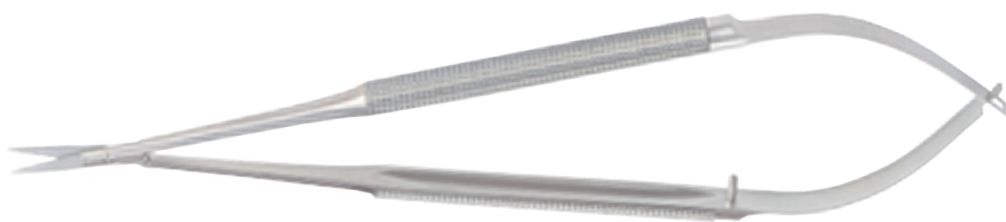
| |  |  |  |  |  |
|------------------|---|---|---|--|---|
| | 25° | 45° | 60° | 90° | 125° |
| | Blatt / Blade / лезвие 14mm | | | | |
| 16,5 cm / 6 1/2" | 03-1489-16 | 03-1490-16 | 03-1491-16 | 03-1492-16 | 03-1493-16 |

Mikro Scheren
Micro Scissors
Микро-ножницы



| BARRAQUER | | | | |
|------------------|---|---|--|---|
| |  |  |  |  |
| | Adventitia / Adventitia / адвентина | | Präparation / Dissection / диссекция | |
| | Blatt / Blade / лезвие 9 mm | | | |
| 12 cm / 4 3/4" | 03-1804-12 | 03-1809-12 | 03-1894-12 | 03-1899-12 |
| 15 cm / 6" | 03-1804-15 | 03-1809-15 | 03-1894-15 | 03-1899-15 |
| 18 cm / 7" | 03-1804-18 | 03-1809-18 | 03-1894-18 | 03-1899-18 |
| | Blatt / Blade / лезвие 14 mm | | | |
| 12 cm / 4 3/4" | 03-1800-12 | 03-1805-12 | 03-1890-12 | 03-1895-12 |
| 15 cm / 6" | 03-1800-15 | 03-1805-15 | 03-1890-15 | 03-1895-15 |
| 18 cm / 7" | 03-1800-18 | 03-1805-18 | 03-1890-18 | 03-1895-18 |
| | gezahnt / toothed / зазубренные | | | |
| | Blatt / Blade / лезвие 9 mm | | | |
| 12 cm / 4 3/4" | 03-1806-12 | 03-1810-12 | 03-1896-12 | 03-1891-12 |
| 15 cm / 6" | 03-1806-15 | 03-1810-15 | 03-1896-15 | 03-1891-15 |
| 18 cm / 7" | 03-1806-18 | 03-1810-18 | 03-1896-18 | 03-1891-18 |
| | Blatt / Blade / лезвие 14 mm | | | |
| 12 cm / 4 3/4" | 03-1802-12 | 03-1807-12 | 03-1892-12 | 03-1897-12 |
| 15 cm / 6" | 03-1802-15 | 03-1807-15 | 03-1892-15 | 03-1897-15 |
| 18 cm / 7" | 03-1802-18 | 03-1807-18 | 03-1892-18 | 03-1897-18 |

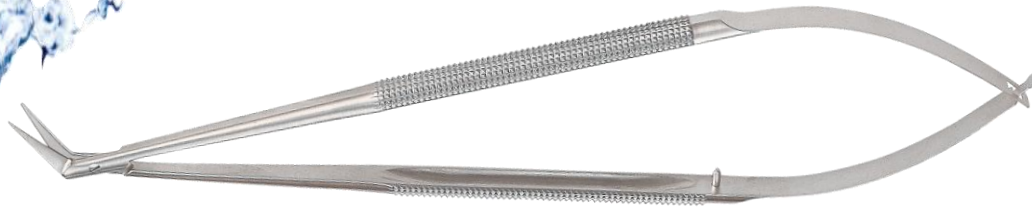





| BARRAQUER | | | | | |
|------------|------------------------------|-------------------|-------------------|-------------------|-------------------|
| | | | | | |
| | 25° | 45° | 60° | 90° | 125° |
| | Blatt / Blade / лезвие 7 mm | | | | |
| 18 cm / 7" | 03-1811-18 | 03-1813-18 | 03-1814-18 | 03-1816-18 | 03-1819-18 |
| | Blatt / Blade / лезвие 11 mm | | | | |
| 18 cm / 7" | 03-1821-18 | 03-1823-18 | 03-1824-18 | 03-1826-18 | 03-1829-18 |
| | | | | | |
| | 25° | 45° | 60° | 90° | 125° |
| | Blatt / Blade / лезвие 11 mm | | | | |
| 18 cm / 7" | 03-1841-18 | 03-1843-18 | 03-1844-18 | 03-1846-18 | 03-1849-18 |



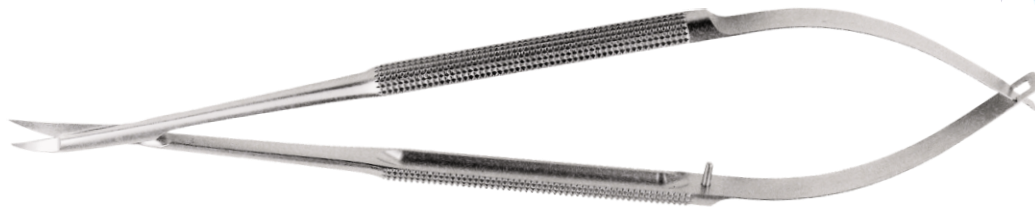









| BARRAQUER - Streamline | | | |
|------------------------|------------------------------|-------------------|-------------------|
| | | | |
| | Blatt / Blade / лезвие 14 mm | | |
| 22 cm / 8 1/2" | 03-1130-22 | 03-1137-22 | 03-1132-22 |

Mikro Scheren
Micro Scissors
Микро-ножницы



| STREAMLINE | | | | |
|----------------|---|---|--|---|
| |  |  |  |  |
| | Adventitia / Adventitia / адвентина | | Präparation / Dissection / диссекция | |
| | Blatt / Blade / лезвие 10 mm | | | |
| 15 cm / 6" | 03-1900-15 | 03-1905-15 | 03-1920-15 | 03-1925-15 |
| 18 cm / 7" | 03-1900-18 | 03-1905-18 | 03-1920-18 | 03-1925-18 |
| 21 cm / 8 1/4" | 03-1900-21 | 03-1905-21 | 03-1920-21 | 03-1925-21 |

| STREAMLINE | | | | | |
|----------------|---|---|---|---|---|
| |  |  |  |  |  |
| | 25° | 45° | 60° | 90° | 125° |
| | Blatt / Blade / лезвие 10 mm | | | | |
| 18 cm / 7" | 03-1921-18 | 03-1923-18 | 03-1924-18 | 03-1926-18 | 03-1929-18 |
| 21 cm / 8 1/4" | 03-1921-21 | 03-1923-21 | 03-1924-21 | 03-1926-21 | 03-1929-21 |

| STREAMLINE | | | | | |
|----------------|---|---|---|---|---|
| |  |  |  |  |  |
| | 25° | 45° | 60° | 90° | 125° |
| | Blatt / Blade / лезвие 10 mm | | | | |
| 18 cm / 7" | 03-1941-18 | 03-1943-18 | 03-1944-18 | 03-1946-18 | 03-1949-18 |
| 21 cm / 8 1/4" | 03-1941-21 | 03-1943-21 | 03-1944-21 | 03-1946-21 | 03-1949-21 |





| TOLEDO Griff - Streamline | | | | |
|---------------------------|--|-------------|---|-------------|
| | | | | |
| | Adventitia / Adventitia / адвентина | | Präparation / Dissection / диссекция | |
| | Blatt / Blade / лезвие 10mm | | | |
| 15 cm / 6" | 03-1900-15T | 03-1905-15T | 03-1920-15T | 03-1925-15T |
| 18 cm / 7" | 03-1900-18T | 03-1905-18T | 03-1920-18T | 03-1925-18T |
| 21 cm / 8 1/4" | 03-1900-21T | 03-1905-21T | 03-1920-21T | 03-1925-21T |











| TOLEDO Griff - Streamline | | | | | | |
|---------------------------|------------------------------|-------------|-------------|-------------|-------------|--|
| | | | | | | |
| | 25° | 45° | 60° | 90° | 125° | |
| | Blatt / Blade / лезвие 7 mm | | | | | |
| 18 cm / 7" | 03-1931-18T | 03-1933-18T | 03-1934-18T | 03-1936-18T | 03-1939-18T | |
| 21 cm / 8 1/4" | 03-1931-21T | 03-1933-21T | 03-1934-21T | 03-1936-21T | 03-1939-21T | |
| | Blatt / Blade / лезвие 10 mm | | | | | |
| 18 cm / 7" | 03-1921-18T | 03-1923-18T | 03-1924-18T | 03-1926-18T | 03-1929-18T | |
| 21 cm / 8 1/4" | 03-1921-21T | 03-1923-21T | 03-1924-21T | 03-1926-21T | 03-1929-21T | |

| TOLEDO Griff - Streamline | | | | | | |
|---------------------------|-----------------------------|-------------|-------------|-------------|-------------|--|
| | | | | | | |
| | 25° | 45° | 60° | 90° | 125° | |
| | Blatt / Blade / лезвие 10mm | | | | | |
| 18 cm / 7" | 03-1941-18T | 03-1943-18T | 03-1944-18T | 03-1946-18T | 03-1949-18T | |
| 21 cm / 8 1/4" | 03-1941-21T | 03-1943-21T | 03-1944-21T | 03-1946-21T | 03-1949-21T | |



Mikro Scheren
Micro Scissors
Микро-ножницы





| TOLEDO 16,5 cm / 6 1/2" | | |
|------------------------------|--|--|
| |  |  |
| Blatt / Blade / лезвие 7 mm | 03-1 881-16T | 03-1 887-16T |
| Blatt / Blade / лезвие 10 mm | 03-1 882-16T | 03-1 888-16T |
| Blatt / Blade / лезвие 14 mm | 03-1 883-16T | 03-1 889-16T |

| TOLEDO | | | | | |
|------------------|---|---|---|---|---|
| |  |  |  |  |  |
| | 25° | 45° | 60° | 90° | 125° |
| | Blatt / Blade / лезвие 7 mm | | | | |
| 16,5 cm / 6 1/2" | 03-1 506-16T | 03-1 507-16T | 03-1 508-16T | 03-1 509-16T | 03-1 510-16T |
| | Blatt / Blade / лезвие 10 mm | | | | |
| 16,5 cm / 6 1/2" | 03-1 476-16T | 03-1 477-16T | 03-1 478-16T | 03-1 479-16T | 03-1 480-16T |
| | Blatt / Blade / лезвие 14 mm | | | | |
| 16,5 cm / 6 1/2" | 03-1 482-16T | 03-1 483-16T | 03-1 484-16T | 03-1 485-16T | 03-1 486-16T |
| |  |  |  |  |  |
| | 25° | 45° | 60° | 90° | 125° |
| | Blatt / Blade / лезвие 10 mm | | | | |
| 16,5 cm / 6 1/2" | 03-1 489-16T | 03-1 490-16T | 03-1 491-16T | 03-1 492-16T | 03-1 493-16T |



| TOLEDO | | | |
|-------------------------------------|--|--|--|
| |  |  |  |
| | gerade/straight/ t/ прямые | aufgebogen/c urved up/ изогнутые вперед | zurückgeboge nen/curved down/ изогнутые назад |
| Blatt / Blade / лезвие 14 mm | | | |
| 16 cm / 6 1/4" | 03-1106-16T | 03-1107-16T | – |
| 20 cm / 8" | 03-1106-20T | 03-1107-20T | 03-1105-20T |
| 23 cm / 9" | 03-1106-23T | 03-1107-23T | 03-1105-23T |
| 25 cm / 9 1/4" | 03-1106-25T | 03-1107-25T | 03-1105-25T |

| TOLEDO | |
|---|---|
|  |  |
| VANNAS | VANNAS aufgebogen/c urved up/ изогнутые вперед |
| Blatt / Blade / лезвие 14 mm | |
| 23 cm / 9" | 03-1108-23T 03-1109-23T |