









**Mikro-Pinzetten
Micro Forceps
Princes micro
Pinzas para microscopia
Микро-пинцеты**











Glatte Maulteile/Smooth Jaws/ Гладкие губки mit Führungsstift Ø 1,5 mm/with guide pin Ø 1.5 mm/ с направляющим штифтом Ø 1,5 мм			
	Glatte Maulteile / smooth Jaws / гладкие губки		
			
	0,3 mm	0,3 mm	0,3 mm
15 cm / 6"	05-9670-15	05-9671-15	05-9675-15A
18 cm / 7"	05-9670-18	05-9671-18	05-9675-18A
21 cm / 8 1/4"	05-9670-21	05-9671-21	
	0,4 mm	0,4 mm	0,4 mm
15 cm / 6"	05-1280-15	05-1285-15	05-1283-15
18 cm / 7"	05-1280-18	05-1285-18	05-1283-18
	0,7 mm	0,7 mm	0,7 mm
15 cm / 6"	05-1380-15	05-1385-15	05-1383-15
18 cm / 7"	05-1380-18	05-1385-18	05-1383-18
21 cm / 8 1/4"	05-9672-21	05-9673-21	



Glatte Maulteile/Smooth Jaws/ Гладкие губки			
	Wolfram-Karbid-Beschichtung /Wolfram Carbide Tip Coating/Покрытие карбид вольфрама		
			
	0,3 mm	0,3 mm	0,3 mm
15 cm / 6"	05-9670-15D	05-9671-15D	05-9675-15DA
18 cm / 7"	05-9670-18D	05-9671-18D	05-9675-18DA
21 cm / 8 1/4"	05-9670-21D	05-9671-21D	
	0,4 mm	0,4 mm	0,4 mm
15 cm / 6"	05-1480-15	05-1485-15	05-1483-15
18 cm / 7"	05-1480-18	05-1485-18	05-1483-18
	0,7 mm	0,7 mm	0,7 mm
15 cm / 6"	05-1486-15	05-1487-15	05-1489-15
18 cm / 7"	05-1486-18	05-1487-18	05-1489-18
21 cm / 8 1/4"	05-9672-21D	05-9673-21D	05-9677-21D

Mikro Pinzetten
Micro Forceps
Микропинцеты

Mit Fadenplatte / with tying platform / с платформой для завязывания нитей

	Glatte Maulteile / smooth Jaws / гладкие губки		Wolfram-Karbid-Beschichtung / Wolfram Carbide Tip Coating / Покрытие карбид вольфрама	
				
	0,3 x 6,0 mm	0,3 x 6,0 mm	0,3 x 6,0 mm	0,3 x 6,0 mm
15 cm / 6"	05-9674-15	05-9675-15	05-9674-15D	05-9675-15D
18 cm / 7"	05-9674-18	05-9675-18	05-9674-18D	05-9675-18D
21 cm / 8 1/4"	05-9674-21	05-9675-21	05-9674-21D	05-9675-21D
	0,7 x 6,0 mm	0,7 x 6,0 mm	0,7 x 6,0 mm	0,7 x 6,0 mm
15 cm / 6"	05-9676-15	05-9677-15	05-9676-15D	05-9677-15D
18 cm / 7"	05-9676-18	05-9677-18	05-9676-18D	05-9677-18D
21 cm / 8 1/4"	05-9676-21	05-9677-21	05-9676-21D	05-9677-21D
1 x 2 Zähne/teeth/зубчики				
	0,3 x 6,0 mm	0,3 x 6,0 mm	0,3 x 6,0 mm	0,3 x 6,0 mm
15 cm / 6"	05-9678-15.03	05-9679-15.03	05-9678-15.03D	05-9679-15.03D
18 cm / 7"	05-9678-18.03	05-9679-18.03	05-9678-18.03D	05-9679-18.03D
21 cm / 8 1/4"	05-9678-21.03	05-9679-21.03	05-9678-21.03D	05-9679-21.03D
	0,7 x 6,0 mm	0,7 x 6,0 mm	0,7 x 6,0 mm	0,7 x 6,0 mm
15 cm / 6"	05-9678-15	05-9679-15	05-9678-15D	05-9679-15D
18 cm / 7"	05-9678-18	05-9679-18	05-9678-18D	05-9679-18D
21 cm / 8 1/4"	05-9678-21	05-9679-21	05-9678-21D	05-9679-21D

Mikro Ring/ Micro Ring/микро колечко

	Glatte Maulteile / smooth Jaws / гладкие губки	Wolfram-Karbid-Beschichtung / Wolfram Carbide Tip Coating / Покрытие карбид вольфрама	Fein gerieft/ fine serrated/ с тонкой насечкой
			
	Ø 1,0 x 0,5 mm	Ø 1,0 x 0,5 mm	1,0 x 0,5 mm
15 cm / 6"	05-1182-15	05-1482-15	05-9681-15
18 cm / 7"	05-1182-18	05-1482-18	05-9681-18
21 cm / 8 1/4"	05-9680-21	05-9680-21D	05-9681-21
	Ø 2,0 x 1,0 mm	Ø 2,0 x 1,0 mm	Ø 2,0 x 1,0 mm
15 cm / 6"	05-9682-15	05-9682-15D	05-9683-15
18 cm / 7"	05-9682-18	05-9682-18D	05-9683-18
21 cm / 8 1/4"	05-9682-21	05-9682-21D	05-9683-21



Mikro Pinzetten
Micro Forceps
Микропинцеты



De BAKEY		
	1,2 mm	1,2 mm
15 cm / 6"	05-9685-15	05-9687-15
18 cm / 7"	05-9685-18	05-9687-18
21 cm / 8 1/4"	05-9685-21	05-9687-21
	2,0 mm	2,0 mm
15 cm / 6"	05-9686-15	05-9688-15
18 cm / 7"	05-9686-18	05-9688-18
21 cm / 8 1/4"	05-9686-21	05-9688-21

Mit eingesetztem Maul/
Serrated Jaws/с зауженными
губками

	Ø 0,3 mm
15 cm / 6"	05-1484-15
18 cm / 7"	05-1484-18





PIERSE
Mit Führungsstift/ with guide
pin / с направляющим
штифтом

	Ø 0,4 mm
15 cm / 6"	05-1481-15
18 cm / 7"	05-1481-18











Titan Mikro Pinzetten
Titanium Micro Forceps
Титановые микропинцеты

Glatte Maulteile/Smooth Jaws/ Гладкие губки mit Führungsstift Ø 1,5 mm/with guide pin Ø 1.5 mm/ с направляющим штифтом Ø 1,5 мм

	Glatte Maulteile / smooth Jaws / гладкие губки		Wolfram-Karbid-Beschichtung /Wolfram Carbide Tip Coating/Покрытие карбид вольфрама	
				
	0,4 mm	0,4 mm	0,4 mm	0,4 mm
15 cm / 6"	05-312-15T	05-313-15T	05-312-15TD	05-313-15TD
18 cm / 7"	05-312-18T	05-313-18T	05-312-18TD	05-313-18TD
21 cm / 8 1/4"	05-312-21T	05-313-21T	05-312-21TD	05-313-21TD
	0,8 mm	0,8 mm	0,8 mm	0,8 mm
15 cm / 6"	05-310-15T	05-311-15T	05-310-15TD	05-311-15TD
18 cm / 7"	05-310-18T	05-311-18T	05-310-18TD	05-311-18TD
21 cm / 8 1/4"	05-310-21T	05-311-21T	05-310-21TD	05-311-21TD

Mit Fadenplatte / with tying platform / с платформой для завязывания нитей mit Führungsstift Ø 1,5 mm/with guide pin Ø 1.5 mm/ с направляющим штифтом Ø 1,5 мм

	Glatte Maulteile / smooth Jaws / гладкие губки		Wolfram-Karbid-Beschichtung /Wolfram Carbide Tip Coating/Покрытие карбид вольфрама	
				
	0,4 x 6,0 mm	0,4 x 6,0 mm	0,4 x 6,0 mm	0,4 x 6,0 mm
15 cm / 6"	05-302-15T	05-303-15T	05-302-15TD	05-303-15TD
18 cm / 7"	05-302-18T	05-303-18T	05-302-18TD	05-303-18TD
21 cm / 8 1/4"	05-302-21T	05-303-21T	05-302-21TD	05-303-21TD
	0,8 x 6,0 mm	0,8 x 6,0 mm	0,8 x 6,0 mm	0,8 x 6,0 mm
15 cm / 6"	05-300-15T	05-301-15T	05-300-15TD	05-301-15TD
18 cm / 7"	05-300-18T	05-301-18T	05-300-18TD	05-301-18TD
21 cm / 8 1/4"	05-300-21T	05-301-21T	05-300-21TD	05-301-21TD
1 x 2 Zähne/teeth/зубчики				
	0,4 x 6,0 mm	0,4 x 6,0 mm	0,4 x 6,0 mm	0,4 x 6,0 mm
15 cm / 6"	05-306-15T	05-307-15T	05-306-15TD	05-307-15TD
18 cm / 7"	05-306-18T	05-307-18T	05-306-18TD	05-307-18TD
21 cm / 8 1/4"	05-306-21T	05-307-21T	05-306-21TD	05-307-21TD
	0,8 x 6,0 mm	0,8 x 6,0 mm	0,8 x 6,0 mm	0,8 x 6,0 mm
15 cm / 6"	05-304-15T	05-305-15T	05-304-15TD	05-305-15TD
18 cm / 7"	05-304-18T	05-305-18T	05-304-18TD	05-305-18TD
21 cm / 8 1/4"	05-304-21T	05-305-21T	05-304-21TD	05-305-21TD

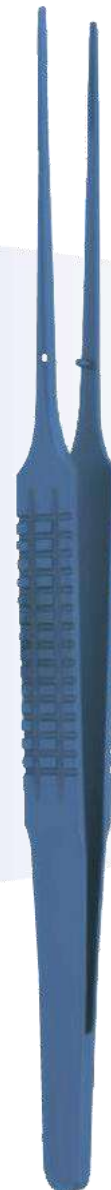



Titan Mikro Pinzetten
Titanium Micro Forceps
Титановые микропинцеты



















Mikro Ring/ Micro Ring/микро колечко Mit Führungsstift Ø 1,5 mm/with guide pin Ø 1.5 mm/ с направляющим штифтом Ø 1,5 мм			
	Glatte Maulteile / smooth Jaws / гладкие губки	Wolfram-Karbid-Beschichtung /Wolfram Carbide Tip Coating/Покрyтие карбид вольфрама	Fein gerieft/ fine serrated/ с тонкой насечкой
	Ø 1,0 x 0,5 mm	Ø 1,0 x 0,5 mm	1,0 x 0,5 mm
15 cm / 6"	05-320-15T	05-320-15TD	05-321-15T
18 cm / 7"	05-320-18T	05-320-18TD	05-321-18T
21 cm / 8 1/4"	05-320-21T	05-320-21TD	05-321-21T
	Ø 2,0 x 1,0 mm	Ø 2,0 x 1,0 mm	Ø 2,0 x 1,0 mm
15 cm / 6"	05-322-15T	05-322-15TD	05-323-15T
18 cm / 7"	05-322-18T	05-322-18TD	05-323-18T
21 cm / 8 1/4"	05-322-21T	05-322-21TD	05-323-21T

De BAKEY Mit Führungsstift Ø 1,5 mm/with guide pin Ø 1.5 mm/ с направляющим штифтом Ø 1,5 мм		
ATRAUMA DE BAKEY		
	1,2 mm	1,2 mm
15 cm / 6"	05-330-15T	05-331-15T
18 cm / 7"	05-330-18T	05-331-18T
21 cm / 8 1/4"	05-330-21T	05-331-21T
	1,8 mm	1,8 mm
15 cm / 6"	05-332-15T	05-333-15T
18 cm / 7"	05-332-18T	05-333-18T
21 cm / 8 1/4"	05-332-21T	05-333-21T



Mikro Pinzetten
Micro Forceps
Микропинцеты

Glatte Maulteile/Smooth Jaws/ Гладкие губки mit Führungsstift Ø 1,5 mm/with guide pin Ø 1.5 mm/ с направляющим штифтом Ø 1,5 мм				
	Glatte Maulteile / smooth Jaws / гладкие губки		Wolfram-Karbid-Beschichtung /Wolfram Carbide Tip Coating/Покрытие карбид вольфрама	
				
	1,0 mm	1,0 mm	1,0 mm	1,0 mm
18 cm / 7"	05-9662-18	05-9663-18	05-1194-18	05-9663-18D
20 cm / 8"	05-9662-20	05-9663-20	05-9662-20D	05-9663-20D
1 x 2 Zähne/teeth/ зубчики				
18 cm / 7"	05-9664-18	05-9665-18	05-9664-18D	05-9665-18D
20 cm / 8"	05-9664-20	05-9665-20	05-9664-20D	05-9665-20D



Mit Fadenplatte / with tying platform / с платформой для завязывания нитей mit Führungsstift Ø 1,5 mm/with guide pin Ø 1.5 mm/ с направляющим штифтом Ø 1,5 мм				
	Glatte Maulteile / smooth Jaws / гладкие губки		Wolfram-Karbid-Beschichtung /Wolfram Carbide Tip Coating/Покрытие карбид вольфрама	
				
	1,0 x 6,0 mm	1,0 x 6,0 mm	1,0 x 6,0 mm	1,0 x 6,0 mm
18 cm / 7"	05-9666-18	05-9667-18	05-9666-18D	05-9667-18D
20 cm / 8"	05-9666-20	05-9667-20	05-1196-20	05-9667-20D
25 cm / 9 3/4"			05-1196-25	
1 x 2 Zähne/teeth/ зубчики				
18 cm / 7"	05-9668-18	05-9669-18	05-9668-18D	05-9669-18D
20 cm / 8"	05-9668-20	05-9669-20	05-9668-20D	05-9669-20D









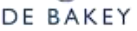



Mikro Pinzetten
Micro Forceps
Микропинцеты



De BAKEY Mit Führungsstift Ø 1,5 mm/with guide pin Ø 1.5 mm/ с направляющим штифтом Ø 1,5 мм		
		
	1,2 mm	2,0 mm
18 cm / 7"	05-1191-18	05-9669-18.1
20 cm / 8"	05-1195-20	05-9669-20.1

Maul gerieft/Jaws serrated/Губки рифленые mit Führungsstift Ø 1,5 mm/with guide pin Ø 1.5 mm/ с направляющим штифтом Ø 1,5 мм		
		
	1,0 mm	1,0 mm
18 cm / 7"	05-1196-18	05-9663-18G
20 cm / 8"	05-1197-20	05-9663-20G
25 cm / 9 3/4"	05-1197-25	

Mikro Ring/ Micro Ring/микро колечко Ø 1,0 x 0,5 mm mit Führungsstift Ø 1,5 mm/with guide pin Ø 1.5 mm/ с направляющим штифтом Ø 1,5 мм		
	Wolfram-Karbid-Beschichtung /Wolfram Carbide Tip Coating/Покрытие карбид вольфрама	
		
18 cm / 7"	05-1160-18D	05-1165-18D
20 cm / 8"	05-9660-20D	05-9660-20DG

Mikro Ring/ Micro Ring/микро колечко Ø 1,0 x 0,5 mm mit Führungsstift Ø 1,5 mm/with guide pin Ø 1.5 mm/ с направляющим штифтом Ø 1,5 мм				
	Glatte Maulteile / smooth Jaws / гладкие губки		Fein gerieft/ fine serrated/ с тонкой насечкой	
				
18 cm / 7"	05-1160-18	05-1165-18	05-9661-18	05-9661-18G
20 cm / 8"	05-9660-20	05-9660-20G	05-9661-20	05-9661-20G

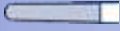

Mikro Pinzetten
Micro Forceps
Микропинцеты

GERALD	
	Hartmetalleinsätze/ Tungsten Carbide Insert Jaws/ вставки из карбид вольфрама *
	1,2 mm
	
17,5 cm / 6 3/4"	05-1920-18
	1,8 mm
	
25 cm / 9 3/4"	05-1920-25D

* Bitte fügen Sie die Typenbezeichnung der Hartmetall-Plättchen (A – B – C – D) der Artikelnummer/ Please add the type symbols of the Tungsten Carbide Inserts (A – B – C – D) to the article number/ Пожалуйста, добавьте символы типа карбида вольфрама вставки в (A - B - C - D) в артикульный номер.

* D = Typenbezeichnung der Hartmetallplättchen/ D = Type symbol of the Tungsten Carbide Inserts / D = обозначение типа карбид вольфрамовой вставки.





Titan-Mikro-Pinzetten
Titanium micro forceps
Титановые микропинцеты

Mit Führungsstift Ø 1,5 mm/with guide pin Ø 1.5 mm/ с направляющим штифтом Ø 1,5 мм

	Glatte Maulteile / smooth Jaws / гладкие губки		Wolfram-Karbid-Beschichtung /Wolfram Carbide Tip Coating/Покрытие карбид вольфрама	
	1,0 mm	1,0 mm	1,0 mm	1,0 mm
18 cm / 7"	05-9662-18T	05-9663-18T	05-9662-18TD	05-9663-18TD
20 cm / 8"	05-9662-20T	05-9663-20T	05-9662-20TD	05-9663-20TD
1 x 2 Zähne/teeth/ зубчики				
18 cm / 7"	05-9664-18T	05-9665-18T	05-9664-18TD	05-9665-18TD
20 cm / 8"	05-9664-20T	05-9665-20T	05-9664-20TD	05-9665-20TD

Mit Fadenplatte / with tying platform / с платформой для завязывания нитей
mit Führungsstift Ø 1,5 mm/with guide pin Ø 1.5 mm/ с направляющим штифтом Ø 1,5 мм

	Glatte Maulteile / smooth Jaws / гладкие губки		Wolfram-Karbid-Beschichtung /Wolfram Carbide Tip Coating/Покрытие карбид вольфрама	
	1,0 x 6,0 mm	1,0 x 6,0 mm	1,0 x 6,0 mm	1,0 x 6,0 mm
18 cm / 7"	05-9666-18T	05-9667-18T	05-9666-18TD	05-9667-18TD
20 cm / 8"	05-9666-20T	05-9667-20T	05-9666-18TD	05-9667-20TD
1 x 2 Zähne/teeth/ зубчики				
18 cm / 7"	05-9668-18T	05-9669-18T	05-9668-18TD	05-9669-18TD
20 cm / 8"	05-9668-20T	05-9669-20T	05-9668-20TD	05-9669-20TD



Mikro Ring/ Micro Ring/микро колечко Ø 1,0 x 0,5 mm
Mit Führungsstift Ø 1,5 mm/with guide pin Ø 1.5 mm/ с направляющим штифтом Ø 1,5 мм

	Glatte Maulteile / smooth Jaws / гладкие губки		Fein gerieft/ fine serrated/ с тонкой насечкой	
	18 cm / 7"	05-9660-18T	05-9660-20TG	05-9661-18T
20 cm / 8"	05-9660-20T	05-9660-20TG	05-9661-20T	05-9661-20TG



Titan-Mikro-Pinzetten
Titanium micro forceps
Титановые микропинцеты

De BAKEY
Mit Führungsstift Ø 1,5 mm/with
guide pin Ø 1.5 mm/ с
направляющим штифтом
Ø 1,5 мм

	
	
	1,2 mm
18 cm / 7"	05-9668-18T.1
20 cm / 8"	05-9668-20T.1
	2,0 mm
18 cm / 7"	05-9669-18T.1
20 cm / 8"	05-9669-20T.1

Mikro Ring/ Micro Ring/микро колечко Ø1,0x0,5 mm
mit Führungsstift Ø 1,5 mm/with guide pin Ø 1.5
mm/ с направляющим штифтом Ø 1,5 мм

Wolfram-Karbid-Beschichtung
/Wolfram Carbide Tip
Coating/Покрытие карбид
вольфрама



18 cm / 7"	05-9660-18TD	05-9660-18TDG
20 cm / 8"	05-9660-20TD	05-9660-20TDG

Tumorfaß Pinzetten Yasargil
Tumor Grasping Forceps Yasargil
Пинцет для опухолей захватывающий Yasargil

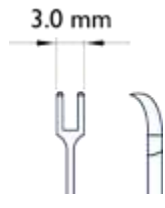





YASARGIL		
		
22 cm / 8 3/4"	05-1127-22	05-1128-22





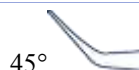

Mikro Pinzetten Yasargil
Micro Forceps Yasargil
Микропинцеты Yasargil



Jacobson mit Führungsstift Ø 1,0 mm/with guide pin Ø 1.0 mm/ с направляющим штифтом Ø 1,0 мм				
Glatte Maulteile / smooth Jaws / гладкие губки				
		45° 		45° 
	0,4 mm	0,4 mm	0,9 mm	0,9 mm
16 cm / 6 1/2"	05-9500-16	05-9503-16	05-9501-16	05-9504-16
18 cm / 7"	05-9500-18	05-9503-18	05-9501-18	05-9504-18
Wolfram-Karbid-Beschichtung / Wolfram Carbide Tip Coating/Покрытие карбид вольфрама				
				
	0,4 mm	0,4 mm	0,9 mm	0,9 mm
16 cm / 6 1/2"	05-9500-16D	05-9503-16D	05-9501-16D	05-9504-16D
18 cm / 7"	05-9500-18D	05-9503-18D	05-9501-18D	05-9504-18D





De BAKEY		
ATRAUMA		
DE BAKEY	1,2 mm	2,0 mm
20 cm / 8"	05-9685-20	05-9686-20
22,5 cm / 9"	05-9685-22	05-9686-22
24 cm / 9 1/4"	05-9685-24	05-9686-24





Mikro Pinzetten Yasargil
Micro Forceps Yasargil
Микропинцеты Yasargil

Yasargil
Mit Führungsstift Ø 1,0 mm / with guide pin Ø 1.0 mm / с направляющим
штифтом Ø 1,0 мм

Glatte Maulteile/Smooth Jaws/ Гладкие губки

		45° 		45° 
	0,4 mm	0,4 mm	0,9 mm	0,9 mm
18 cm / 7"	05-9510-18	05-9515-18	05-9511-18	05-9516-18
22,5 cm / 9"	05-9510-22	05-9515-22	05-9511-22	05-9516-22
24 cm / 9 1/4"	05-9510-24	05-9515-24	05-9511-24	05-9516-24

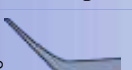
**Wolfram-Karbid-Beschichtung /Wolfram Carbide Tip
Coating/Покрытие карбид вольфрама**

		45° 		45° 
	0,4 mm	0,4 mm	0,9 mm	0,9 mm
18 cm / 7"	05-9510-18D	05-9515-18D	05-9511-18D	05-9516-18D
22,5 cm / 9"	05-9510-22D	05-9515-22D	05-9511-22D	05-9516-22D
24 cm / 9 1/4"	05-9510-24D	05-9515-24D	05-9511-24D	05-9516-24D

Maul löffelförmig, glatt /Spoon-shaped jaws,
smooth /губки ложкообразные, гладкие

	Ø 3,0 mm	Ø 5,0 mm
22 cm / 8 3/4"	05-9550-22	05-9552-22



Maul flachgezahnt / jaws flat serrated /губки с
плоскими зубчиками

	Ø 3,0 mm	Ø 5,0 mm
22 cm / 8 3/4"	05-9554-22	05-9556-22



Maul kürettenförmig / jaws curette toothed
/губки кюреткообразные

	Ø 3,0 mm	Ø 5,0 mm
22 cm / 8 3/4"	05-9557-22	05-9558-22





Mikro Pinzetten Yasargil
Micro Forceps Yasargil
Микропинцеты Yasargil

Yasargil					
Glatte Maulteile/Smooth Jaws/ Гладкие губки					
	Spitz/ sharp/ острые	Halb spitz/ Half sharp/ полуострые	Spitz/ sharp/ острые	Stumpf/blunt/ тупые	Stumpf/blunt/ тупые
	0,4 mm	0,6 mm	0,4 mm	0,9 mm	0,9 mm
16 cm / 6 1/2"	05-9610-16	05-1130-16	05-9615-16	05-1131-16	05-9616-16
18 cm / 7"	05-9610-18	05-1130-18	05-9615-18	05-1131-18	05-9616-18
20 cm / 8"	05-9610-20	05-1130-20	05-9615-20	05-1131-20	05-9616-20
22,5 cm / 9"	05-9610-22	05-1130-22	05-9615-22	05-1131-22	05-9616-22
24 cm / 9 1/4"	05-9610-24	05-1130-24	05-9615-24	05-1131-24	05-9616-24
Wolfram-Karbid-Beschichtung /Wolfram Carbide Tip Coating/Покрытие карбид вольфрама					
	Spitz/ sharp/ острые	Halb spitz/ Half sharp/ полуострые	Spitz/ sharp/ острые	Stumpf/blunt/ тупые	Stumpf/blunt/ тупые
16 cm / 6 1/2"	05-9610-16D	05-1134-16	05-9615-16D	05-1135-16	05-9616-16D
18 cm / 7"	05-9610-18D	05-1134-18	05-9615-18D	05-1135-18	05-9616-18D
20 cm / 8"	05-9610-20D	05-1134-20	05-9615-20D	05-1135-20	05-9616-20D
22,5 cm / 9"	05-9610-22D	05-1134-22	05-9615-22D	05-1135-22	05-9616-22D
24 cm / 9 1/4"	05-9610-24D	05-1134-24	05-9615-24D	05-1135-24	05-9616-24D
1 x 2 Zähne/teeth/ зубчики					
				Wolfram-Karbid-Beschichtung /Wolfram Carbide Tip Coating/Покрытие карбид вольфрама	
	1,0 mm	1,2 mm	1,0 mm		
16 cm / 6 1/2"	05-9613-16			05-9613-16D	
18 cm / 7"	05-9613-18	05-1138-18		05-9613-18D	
20 cm / 8"	05-9613-20			05-9613-20D	
22,5 cm / 9"	05-9613-22			05-9613-22D	
24 cm / 9 1/4"	05-9613-24			05-9613-24D	



Mikro Pinzetten Yasargil
Micro Forceps Yasargil
Микропинцеты Yasargil

Mit Führungsstift / with guide pin / с направляющим штифтом

Glatte Maulteile / smooth Jaws / гладкие губки		
	0,6 mm	0,9 mm
23 cm / 9"	05-1132-23	05-1133-23

Glatte Maulteile , mit Führungsstift /Smooth Jaws, with guide pin /
Гладкие губки с направляющим штифтом



Wolfram-Karbid-Beschichtung /Wolfram Carbide Tip Coating/Покрытие карбид вольфрама		
	0,6 mm	0,9 mm
23 cm / 9"	05-1136-23	05-1136-23

Mikro Ring/ Micro Ring/микро колечко
Mit Führungsstift Ø 1,0 mm/with guide pin Ø 1.0 mm/с
направляющим штифтом Ø 1,0 mm



	Glatte Maulteile / smooth Jaws / гладкие губки	Wolfram-Karbid- Beschichtung /Wolfram Carbide Tip Coating/Покрытие карбид вольфрама	Fein gerieft/ fine serrated/ с тонкой насечкой
	Ø 1,0 x 0,5 mm	Ø 1,0 x 0,5 mm	1,0 x 0,5 mm
20 cm / 8"	05-9620-20	05-9620-20D	05-9621-20
22,5 cm / 9"	05-9620-22	05-9620-22D	05-9621-22
24 cm / 9 1/2"	05-9620-24	05-9620-24D	05-9621-24
	Ø 2,0 x 1,0 mm	Ø 2,0 x 1,0 mm	Ø 2,0 x 1,0 mm
20 cm / 8"	05-9622-20	05-9622-20D	05-9623-20
22,5 cm / 9"	05-9622-22	05-9622-22D	05-9623-22
24 cm / 9 1/2"	05-9622-24	05-9622-24D	05-9623-24





**Maul löffelförmig, glatt/Spoon-shaped, smooth jaws/губки
ложкообразные, гладкие**

			
	Ø 3,0 mm	Ø 5,0 mm	Ø 7,0 mm
22 cm / 8 3/4"	05-1122-22	05-1125-22	
22,5 cm / 9"	05-9650-22	05-9652-22	05-9653-22
24 cm / 9 1/2"	05-1122-24	05-1125-24	05-9653-24

**Maul löffelförmig mit 16 Zähnen, fein gezahnt /Spoon-shaped
jaws with 16 teeth, fine serrated /губки ложкаобразные с 16
зубчиками, с тонкой насечкой**

	Ø 3,0 mm	Ø 3,0 mm	Ø 5,0 mm
			
16 cm / 6 1/2"	05-1121-16		05-1124-16
20 cm / 8"	05-1121-20		05-1124-20
22 cm / 8 3/4"	05-1121-22	05-1126-22	05-1124-22

**Maul löffelförmig mit 14 Zähnen, grob gezahnt
/Spoon-shaped jaws with 14 teeth, heavily
serrated /губки ложкаобразные с 14
зубчиками, с грубой насечкой**

	Ø 3,0 mm	Ø 5,0 mm
		
16 cm / 6 1/2"	05-1120-16	05-1123-16
20 cm / 8"	05-1120-20	05-1123-20
22 cm / 8 3/4"	05-1120-22	05-1123-22

**Maul flachgezahnt / jaws flat serrated /губки с
плоскими зубчиками**

	Ø 3,0 mm	Ø 5,0 mm
22,5 cm / 9"	05-9654-22	05-9656-22
24 cm / 9 1/2"	05-9654-24	05-9656-24

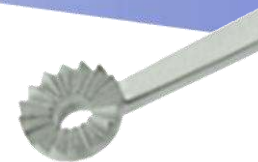

**Maul kürettenförmig / jaws curette toothed
/губки куреткообразные**

	Ø 3,0 mm	Ø 5,0 mm
22,5 cm / 9 "	05-9657-22	05-9658-22
24 cm / 9 1/2"	05-9657-24	05-9658-24







Mikro Pinzetten
Micro Forceps
Микропинцеты



Maul löffelförmig, glatt / Spoon-shaped, smooth jaws / губки ложкообразные, гладкие			
	Ø 3,0 mm	Ø 4,0 mm	Ø 5,0 mm
	aufwärts gebogen, 70° / curved upwards, 70° / изогнуты вперед 70°		
23 cm / 9"	05-1150-23	05-1151-23	05-1152-23
Maul löffelförmig, glatt / Spoon-shaped, smooth jaws / губки ложкообразные, гладкие			
	Ø 3,0 mm	Ø 4,0 mm	Ø 5,0 mm
	abwärts gebogen, 70° / curved downwards, 70° / изогнуты назад 70°		
23 cm / 9"	05-1153-23	05-1154-23	05-1155-23
Maul löffelförmig, glatt / Spoon-shaped, smooth jaws / губки ложкообразные, гладкие			
	Ø 3,0 mm	Ø 4,0 mm	Ø 5,0 mm
	aufwärts gebogen, 70° / curved upwards, 70° / изогнуты вперед 70°		
23 cm / 9"	05-9660-23T	05-9661-23T	05-9662-23T
Maul löffelförmig, glatt / Spoon-shaped, smooth jaws / губки ложкообразные, гладкие			
	Ø 3,0 mm	Ø 4,0 mm	Ø 5,0 mm
	abwärts gebogen, 70° / curved downwards, 70° / изогнуты назад 70°		
23 cm / 9"	05-9665-23T	05-9666-23T	05-9667-23T





Titan –Yasargil Mikro Pinzette
Titanium Yasargil micro forceps
Титановые микро пинцеты Yasargil

Yasargil Glatte Maulteile/Smooth Jaws/ Гладкие губки					
					
	Spitz/ sharp/ острые	Spitz/ sharp/ острые	Stumpf/blunt/ тупые	Stumpf/blunt/ тупые	1 x 2 Zähne/teeth/ зубчики
	0,4 mm	0,4 mm	0,9 mm	0,9 mm	1,0 mm
20 cm / 8"	05-390-20T	05-392-20T	05-391-20T	05-393-20T	05-394-20T
22,5 cm / 9"	05-390-22T	05-392-22T	05-391-22T	05-393-22T	05-394-22T
24 cm / 9 1/4"	05-390-24T	05-392-24T	05-391-24T	05-393-24T	05-394-24T
Wolfram-Karbid-Beschichtung /Wolfram Carbide Tip Coating/Покрытие карбид вольфрама					
					
	Spitz/ sharp/ острые	Spitz/ sharp/ острые	Stumpf/blunt/ тупые	Stumpf/blunt/ тупые	1 x 2 Zähne/teeth/ зубчики
	0,4 mm	0,4 mm	0,9 mm	0,9 mm	1,0 mm
20 cm / 8"	05-390-20TD	05-392-20TD	05-391-20TD	05-393-20TD	05-394-20TD
22,5 cm / 9"	05-390-22TD	05-392-22TD	05-391-22TD	05-393-22TD	05-394-22TD
24 cm / 9 1/4"	05-390-24TD	05-392-24TD	05-391-24TD	05-393-24TD	05-394-24TD

Mikro Ring/ Micro Ring/микро колечко Mit Führungsstift Ø 1,0 mm/with guide pin Ø 1.0 mm/c направляющим штифтом Ø 1,0 мм			
	Glatte Maulteile / smooth Jaws / гладкие губки	Wolfram- Karbid- Beschichtung /Wolfram Carbide Tip Coating/Покр ытие карбид вольфрама	Fein gerieft/ fine serrated/ c тонкой насечкой
	Ø 1,0 x 0,5 mm	Ø 1,0 x 0,5 mm	1,0 x 0,5 mm
			
20 cm / 8"	05-395-20T	05-395-20TD	05-396-20T
22,5 cm / 9"	05-395-22T	05-395-22TD	05-396-22T
24 cm / 9 1/2"	05-395-24T	05-395-24TD	05-396-24T
	Ø 2,0 x 1,0 mm	Ø 2,0 x 1,0 mm	Ø 2,0 x 1,0 mm
20 cm / 8"	05-397-20T	05-397-20TD	05-398-20T
22,5 cm / 9"	05-397-22T	05-397-22TD	05-398-22T
24 cm / 9 1/2"	05-397-24T	05-397-24TD	05-398-24T



Titan –Yasargil Mikro Pinzette
Titanium Yasargil micro forceps
Титановые микро пинцеты Yasargil

De BAKEY		
	1,2 mm	2,0 mm
20 cm / 8"	05-9685-20T	05-9686-20T
22,5 cm / 9"	05-9685-22T	05-9686-22T
24 cm / 9¼"	05-9685-24T	05-9686-24T



Maul flachgezahnt / jaws flat serrated / губки с плоскими зубчиками			
	Ø 3,0 mm	Ø 5,0 mm	
22,5 cm / 9"	05-9654-22T	05-9656-22T	
24 cm / 9 ½"	05-9654-24T	05-9656-24T	

Maul kürettenförmig / jaws curette toothed / губки кюреткообразные			
	Ø 3,0 mm	Ø 5,0 mm	
22,5 cm / 9"	05-9657-22T	05-9658-22T	
24 cm / 9 ½"	05-9657-24T	05-9658-24T	









Maul löffelförmig, glatt/Spoon-shaped, smooth jaws/губки ложкообразные, гладкие				
	Ø 3,0 mm	Ø 5,0 mm	Ø 7,0 mm	
22,5 cm / 9"	05-9650-22T	05-9652-22T	05-9653-22T	
24 cm / 9 1/2"	05-9650-24T	05-9652-24T	05-9653-24T	





Mikro Pinzette Rundgriff
Micro Forceps round Handle
Микро пинцет круглая ручка



Mit Fadenplatte / with tying platform / с платформой для завязывания нитей				
	Glatte Maulteile / smooth Jaws / гладкие губки		Wolfram-Karbid-Beschichtung / Wolfram Carbide Tip Coating / Покрытие карбид вольфрама	
				
	0,4 x 7,0 mm	0,4 x 7,0 mm	0,4 x 7,0 mm	0,4 x 7,0 mm
18 cm / 7"	05-1683-18	05-1685-18	05-1703-18	05-1705-18
21 cm / 8 1/4"	05-1683-21	05-1685-21	05-1703-21	05-1705-21
23 cm / 9"	05-1683-23	05-1685-23	05-1703-23	05-1705-23
	0,7 x 7,0 mm	0,7 x 7,0 mm	0,7 x 7,0 mm	0,7 x 7,0 mm
18 cm / 7"	05-1680-18	05-1681-18	05-1700-18	05-1701-18
21 cm / 8 1/4"	05-1680-21	05-1681-21	05-1700-21	05-1701-21
23 cm / 9"	05-1680-23	05-1681-23	05-1700-23	05-1701-23
Mikro Ring/ Micro Ring/микро колечко Ø 1,0 x 0,5 mm				
	Glatte Maulteile / smooth Jaws / гладкие губки		Wolfram-Karbid-Beschichtung / Wolfram Carbide Tip Coating / Покрытие карбид вольфрама	
				
	Ø 1,0 x 0,5 mm		Ø 1,0 x 0,5 mm	
18 cm / 7"	05-1690-18		05-1710-18	
21 cm / 8 1/4"	05-1690-21		05-1710-21	
23 cm / 9"	05-1690-23		05-1710-23	





Mikro Pinzette Rundgriff
Micro Forceps round Handle
Микро пинцет круглая ручка

Mit Führungsstift, Fadenplatte / with guide pin, tying platform / с направляющим штифтом, платформа для завязывания нитей





	Glatte Maulteile / smooth Jaws / гладкие губки		Wolfram-Karbid-Beschichtung /Wolfram Carbide Tip Coating/Покрытие карбид вольфрама	
	0,3 x 6,0 mm	0,3 x 6,0 mm	0,3 x 6,0 mm	0,3 x 6,0 mm
12 cm / 4 3/4"	05-9074-12	05-9075-12	05-9074-12D	05-9075-12D
15 cm / 6"	05-9074-15	05-9075-15	05-9074-15D	05-9075-15D
18 cm / 7"	05-9074-18	05-9075-18	05-9074-18D	05-9075-18D
21 cm / 8 1/4"	05-9074-21	05-9075-21	05-9074-21D	05-9075-21D
23 cm / 9"	05-9074-23	05-9075-23	05-9074-23D	05-9075-23D
	0,4 x 7,0 mm	0,4 x 7,0 mm	0,4 x 7,0 mm	0,4 x 7,0 mm
15 cm / 6"	05-1170-15	05-1175-15	05-1580-15	05-1585-15
18 cm / 7"	05-1170-18	05-1175-18	05-1580-18	05-1585-18
21 cm / 8 1/4"	05-1170-21	05-1175-21	05-1580-21	05-1585-21
23 cm / 9"	05-1170-23	05-1175-23	05-1580-23	05-1585-23
	0,7 x 7,0 mm	0,7 x 7,0 mm	0,7 x 7,0 mm	0,7 x 7,0 mm
12 cm / 4 3/4"	05-9076-12	05-9077-12	05-9076-12D	05-9077-12D
15 cm / 6"	05-1171-15	05-1176-15	05-1581-15	05-1586-15
18 cm / 7"	05-1171-18	05-1176-18	05-1581-18	05-1586-18
21 cm / 8 1/4"	05-1171-21	05-1176-21	05-1581-21	05-1586-21
23 cm / 9"	05-1171-23	05-1176-23	05-1581-23	05-1586-23
	Glatte Maulteile / smooth Jaws / гладкие губки		Wolfram-Karbid-Beschichtung /Wolfram Carbide Tip Coating/Покрытие карбид вольфрама	
1 x 2 Zähne/teeth/ зубчики				
	0,3 x 6,0 mm	0,3 x 6,0 mm	0,3 x 6,0 mm	0,3 x 6,0 mm
12 cm / 4 3/4"	05-9078-12-0.3	05-9079-12-0.3	05-9078-12-0.3D	05-9079-12-0.3D
15 cm / 6"	05-9078-15-0.3	05-9079-15-0.3	05-9078-15-0.3D	05-9079-15-0.3D
18 cm / 7"	05-9078-18-0.3	05-9079-18-0.3	05-9078-18-0.3D	05-9079-18-0.3D
21 cm / 8 1/4"	05-9078-21-0.3	05-9079-21-0.3	05-9078-21-0.3D	05-9079-21-0.3D
23 cm / 9"	05-9078-23-0.3	05-9079-23-0.3	05-9078-23-0.3D	05-9079-23-0.3D
	0,7 x 6,0 mm	0,7 x 6,0 mm	0,7 x 6,0 mm	0,7 x 6,0 mm
12 cm / 4 3/4"	05-9078-12	05-9079-12	05-9078-12D	05-9079-12D
15 cm / 6"	05-9078-15	05-9079-15	05-9078-15D	05-9079-15D
18 cm / 7"	05-9078-18	05-9079-18	05-9078-18D	05-9079-18D
21 cm / 8 1/4"	05-9078-21	05-9079-21	05-9078-21D	05-9079-21D
23 cm / 9"	05-9078-23	05-9079-23	05-9078-23D	05-9079-23D









Mikro Pinzette Rundgriff
Micro Forceps round Handle
Микро пинцет круглая ручка

Mit Führungsstift/ with guide pin / с направляющим штифтом

	Glatte Maulteile / smooth Jaws / гладкие губки		Wolfram-Karbid-Beschichtung /Wolfram Carbide Tip Coating/Покрытие карбид вольфрама	
				
	0,3 mm	0,3 mm	0,3 mm	0,3 mm
12 cm / 4 3/4"	05-9070-12	05-9071-12	05-9070-12D	05-9071-12D
15 cm / 6"	05-9070-15	05-9071-15	05-9070-15D	05-9071-15D
18 cm / 7"	05-9070-18	05-9071-18	05-9070-18D	05-9071-18D
21 cm / 8 1/4"	05-9070-21	05-9071-21	05-9070-21D	05-9071-21D
23 cm / 9"	05-9070-23	05-9071-23	05-9070-23D	05-9071-23D
	0,7 mm	0,7 mm	0,7 mm	0,7 mm
12 cm / 4 3/4"	05-9072-12	05-9073-12	05-9072-12D	05-9073-12D
15 cm / 6"	05-9072-15	05-9073-15	05-9072-15D	05-9073-15D
18 cm / 7"	05-9072-18	05-9073-18	05-9072-18D	05-9073-18D
21 cm / 8 1/4"	05-9072-21	05-9073-21	05-9072-21D	05-9073-21D
23 cm / 9"	05-9072-23	05-9073-23	05-9072-23D	05-9073-23D

1 x 2 Zähne/teeth/ зубчики



Mit Führungsstift/ with guide pin / с направляющим штифтом

	Glatte Maulteile / smooth Jaws / гладкие губки		Wolfram-Karbid-Beschichtung /Wolfram Carbide Tip Coating/Покрытие карбид вольфрама	
				
	Ø 0,4 mm	Ø 0,4 mm	Ø 0,4 mm	Ø 0,4 mm
15 cm / 6"	05-1290-15	05-1295-15	05-1590-15	05-1595-15
18 cm / 7"	05-1290-18	05-1295-18	05-1590-18	05-1595-18
21 cm / 8 1/4"	05-1290-21	05-1295-21	05-1590-21	05-1595-21
	Ø 0,7 mm	Ø 0,7 mm	Ø 0,7 mm	Ø 0,7 mm
15 cm / 6"	05-1291-15	05-1296-15	05-1591-15	05-1596-15
18 cm / 7"	05-1291-18	05-1296-18	05-1591-18	05-1596-18
21 cm / 8 1/4"	05-1291-21	05-1296-21	05-1591-21	05-1596-21





Mikro Pinzette Rundgriff
Micro Forceps round Handle
Микро пинцет круглая ручка

De BAKEY		
		
	1,2 mm	1,2 mm
15 cm / 6"	05-1190-15	05-1195-15
18 cm / 7"	05-1190-18	05-1195-18
21 cm / 8 1/4"	05-1190-21	05-1195-21

Mit eingesetztem Maul/
Serrated Jaws/с заужеными
губками
Mit Führungsstift/ with guide pin /
с направляющим штифтом



Ø 0,3 mm

12 cm/4 3/4"	05-9070-12-DIL
15 cm / 6"	05-9070-15-DIL
18 cm / 7"	05-9070-18-DIL

PIERSE
Mit Führungsstift/ with guide pin /
с направляющим штифтом

Ø 0,3 mm







12 cm/4 3/4"	05-9070-12-P
15 cm / 6"	05-9070-15-P
18 cm / 7"	05-9070-18-P





Mikro Pinzette Rundgriff
Micro Forceps round Handle
Микро пинцет круглая ручка

Mikro Ring/ Micro Ring/микро колючко Mit Führungsstift/ with guide pin / с направляющим штифтом				
	Glatte Maulteile / smooth Jaws / гладкие губки		Wolfram-Karbid- Beschichtung /Wolfram Carbide Tip Coating/Покрытие карбид вольфрама	
				
	1,0 x 0,5 mm	1,0 x 0,5 mm	1,0 x 0,5 mm	1,0 x 0,5 mm
12 cm/4 3/4"	05-9080-12	05-9080-12G	05-9080-12D	05-9080-12GD
15 cm / 6"	05-1180-15	05-1185-15	05-1660-15	05-1665-15
18 cm / 7"	05-1180-18	05-1185-18	05-1660-18	05-1665-18
21 cm / 8 1/4"	05-1180-21	05-1185-21	05-1660-21	05-1665-21
23 cm / 9"	05-1180-23	05-1185-23	05-1660-23	05-1665-23
	2,0 x 0,8 mm	2,0 x 0,8 mm	2,0 x 0,8 mm	2,0 x 0,8 mm
15 cm / 6"	05-1181-15	05-1186-15	05-1661-15	05-1666-15
18 cm / 7"	05-1181-18	05-1186-18	05-1661-18	05-1666-18
21 cm / 8 1/4"	05-1181-21	05-1186-21	05-1661-21	05-1666-21
	2,0 x 1,0 mm	2,0 x 1,0 mm	2,0 x 1,0 mm	2,0 x 1,0 mm
12 cm/4 3/4"	05-9082-12	05-9082-12G	05-9082-12D	05-9082-12GD
15 cm / 6"	05-9082-15	05-9082-15G	05-9082-15D	05-9082-15GD
18 cm / 7"	05-9082-18	05-9082-18G	05-9082-18D	05-9082-18GD
21 cm / 8 1/4"	05-9082-21	05-9082-21G	05-9082-21D	05-9082-21GD
23 cm / 9"	05-9082-23	05-9082-23G	05-9082-23D	05-9082-23GD



Mikro Ring/ Micro Ring/микро колючко
Mit Führungsstift, Fadenplatte / with guide pin,
tying platform / с направляющим штифтом,
платформа для завязывания нитей

	Wolfram-Karbid- Beschichtung /Wolfram Carbide Tip Coating/Покрытие карбид вольфрама	
		
	1,0 x 0,5 mm	2,0 x 1,0 mm
12 cm/4 3/4"	05-9085-12D	05-9087-12D
15 cm / 6"	05-9085-15D	05-9087-15D
18 cm / 7"	05-1714-18	05-9087-18D
21 cm / 8 1/4"	05-1714-21	05-9087-21D
23 cm / 9"	05-9085-23D	05-9087-23D









Mikro Pinzette Rundgriff
Micro Forceps round Handle
Микро пинцет круглая ручка

Mikro Ring/ Micro Ring/микро колючко
Mit Führungsstift/ with guide pin/ с
направляющим штифтом

	Fein gerieft/ fine serrated/ с тонкой насечкой	
		
	1,0 x 0,5 mm	1,0 x 0,5 mm
12 cm/4 3/4"	05-9081-12	05-9081-12G
15 cm / 6"	05-9081-15	05-9081-15G
18 cm / 7"	05-9081-18	05-9081-18G
21 cm / 8 1/4"	05-9081-21	05-9081-21G
23 cm / 9"	05-9081-23	05-9081-23G
	2,0 x 1,0 mm	2,0 x 1,0 mm
12 cm/4 3/4"	05-9083-12	05-9083-12G
15 cm / 6"	05-9083-15	05-9083-15G
18 cm / 7"	05-9083-18	05-9083-18G
21 cm / 8 1/4"	05-9083-21	05-9083-21G
23 cm / 9"	05-9083-23	05-9083-23G









Mit Führungsstift/ with guide pin / с направляющим штифтом

	Glatte Maulteile / smooth Jaws / гладкие губки			Wolfram-Karbid-Beschichtung /Wolfram Carbide Tip Coating/Покрытие карбид вольфрама		
			45° 			45° 
	0,3 mm	0,3 mm	0,3 mm	0,3 mm	0,3 mm	0,3 mm
12 cm/4 3/4"	05-9070-12	05-9071-12	05-9075-12A	05-9070-12D	05-9071-12D	05-9075-12AD
15 cm / 6"	05-9070-15	05-9071-15	05-9075-15A	05-9070-15D	05-9071-15D	05-9075-15AD
18 cm / 7"	05-9070-18	05-9071-18	05-9075-18A	05-9070-18D	05-9071-18D	05-9075-18AD
21 cm / 8 1/4"	05-9070-21	05-9071-21		05-9070-21D	05-9071-21D	
23 cm / 9"	05-9070-23	05-9071-23		05-9070-23D	05-9071-23D	
	0,7 mm	0,7 mm		0,7 mm	0,7 mm	
12 cm/4 3/4"	05-9072-12	05-9073-12		05-9072-12D	05-9073-12D	
15 cm / 6"	05-9072-15	05-9073-15		05-9072-15D	05-9073-15D	
18 cm / 7"	05-9072-18	05-9073-18		05-9072-18D	05-9073-18D	
21 cm / 8 1/4"	05-9072-21	05-9073-21		05-9072-21D	05-9073-21D	
23 cm / 9"	05-9072-23	05-9073-23		05-9072-23D	05-9073-23D	



Mikro Pinzette Rundgriff
Micro Forceps round Handle
Микро пинцет круглая ручка





De BAKEY Model ohne Führungsstift/Modell w/o guide pin/ Модель без направляющего штифта				
  DE BAKEY	Hartmetalleinsätze/Tungsten Carbide Insert Jaws/ вставки из карбид вольфрама			
				
	1,2 mm	1,2 mm	1,2 mm	1,2 mm
12 cm / 4 3/4"	05-9085-12	05-9087-12		
15 cm / 6"	05-9085-15	05-9087-15	05-9090-15	05-9092-15
18 cm / 7"	05-9085-18	05-9087-18	05-9090-18	05-9092-18
21 cm / 8 1/4"	05-9085-21	05-9087-21	05-9090-21	05-9092-21
23 cm / 9"	05-9085-23	05-9087-23	05-9090-23	05-9092-23
	2,0 mm	2,0 mm	2,0 mm	2,0 mm
12 cm / 4 3/4"	05-9086-12	05-9088-12		
15 cm / 6"	05-9086-15	05-9088-15	05-9091-15	05-9093-15
18 cm / 7"	05-9086-18	05-9088-18	05-9091-18	05-9093-18
21 cm / 8 1/4"	05-9086-21	05-9088-21	05-9091-21	05-9093-21
23 cm / 9"	05-9086-23	05-9088-23	05-9091-23	05-9093-23









Mikro Pinzette Rundgriff Titan
Micro Forceps Round Handle Titan
Микро пинцет круглая ручка Титан

De BAKEY
Model ohne Führungsstift/Modell w/o guide pin/
Модель без направляющего штифта

		
ATRAUMA  DE BAKEY	1,2 mm	1,2 mm
12 cm 4¾"	05-130-12T	05-131-12T
15 cm / 6"	05-130-15T	05-131-15T
18 cm / 7"	05-11190-18	05-11195-18
21 cm / 8 1/4"	05-11190-21	05-11195-21
23 cm / 9"	05-130-23T	05-131-23T
	1,8 mm	1,8 mm
12 cm 4¾"	05-132-12T	05-133-12T
15 cm / 6"	05-132-15T	05-133-15T
18 cm / 7"	05-132-18T	05-133-18T
21 cm / 8 1/4"	05-133-21T	05-133-21T
23 cm / 9"	05-133-23T	05-133-23T









Glatte Maulteile / smooth Jaws / гладкие губки
Mit Führungsstift/ with guide pin/ с направляющим штифтом

	Glatte Maulteile / smooth Jaws / гладкие губки		Wolfram-Karbid-Beschichtung / Wolfram Carbide Tip Coating / Покрытие карбид вольфрама	
				
	0,4 mm	0,4 mm	0,4 mm	0,4 mm
12 cm 4¾"	05-112-12T	05-113-12T	05-112-12TD	05-113-12TD
15 cm / 6"	05-112-15T	05-113-15T	05-112-15TD	05-113-15TD
18 cm / 7"	05-112-18T	05-113-18T	05-112-18TD	05-113-18TD
21 cm / 8 1/4"	05-112-21T	05-113-21T	05-112-21TD	05-113-21TD
23 cm / 9"	05-112-23T	05-113-23T	05-112-23TD	05-113-23TD
	0,8 mm	0,8 mm	0,8 mm	0,8 mm
12 cm 4¾"	05-110-12T	05-111-12T	05-110-12TD	05-111-12TD
15 cm / 6"	05-110-15T	05-111-15T	05-110-15TD	05-111-15TD
18 cm / 7"	05-110-18T	05-111-18T	05-110-18TD	05-111-18TD
21 cm / 8 1/4"	05-110-21T	05-111-21T	05-110-21TD	05-111-21TD
23 cm / 9"	05-110-23T	05-111-23T	05-110-23TD	05-111-23TD



Mikro Pinzette Rundgriff Titan
Micro Forceps Round Handle Titan
Микро пинцет круглая ручка Титан





Mit Fadenplatte / with tying platform / с платформой для завязывания нитей



	Glatte Maulteile / smooth Jaws / гладкие губки		Wolfram-Karbid-Beschichtung / Wolfram Carbide Tip Coating / Покрытие карбид вольфрама	
				
	0,4 x 7,0 mm	0,4 x 7,0 mm	0,4 x 7,0 mm	0,4 x 7,0 mm
12 cm 4¾"	05-102-12T	05-103-12T	05-102-12TD	05-103-12TD
15 cm / 6"	05-102-15T	05-103-15T	05-102-15TD	05-103-15TD
18 cm / 7"	05-11171-18	05-11176-18	05-11581-18	05-11586-18
21 cm / 8 1/4"	05-11171-21	05-11176-21	05-11581-21	05-11586-21
23 cm / 9"	05-102-23T	05-103-23T	05-102-23TD	05-103-23TD
	0,7 x 7,0 mm	0,7 x 7,0 mm	0,7 x 7,0 mm	0,7 x 7,0 mm
12 cm 4¾"	05-100-12T	05-101-12T	05-100-12TD	05-101-12TD
15 cm / 6"	05-100-15T	05-101-15T	05-100-15TD	05-101-15TD
18 cm / 7"	05-11170-18	05-11175-18	05-11580-18	05-11585-18
21 cm / 8 1/4"	05-11170-21	05-11175-21	05-11580-21	05-11585-21
23 cm / 9"	05-100-23T	05-101-23T	05-100-23TD	05-101-23TD
1 x 2 Zähne/teeth/зубчики				
	0,4 x 6,0 mm	0,4 x 6,0 mm	0,4 x 6,0 mm	0,4 x 6,0 mm
12 cm 4¾"	05-106-12T	05-107-12T	05-106-12TD	05-107-12TD
15 cm / 6"	05-106-15T	05-107-15T	05-106-15TD	05-107-15TD
18 cm / 7"	05-106-18T	05-107-18T	05-106-18TD	05-107-18TD
21 cm / 8 1/4"	05-106-21T	05-107-21T	05-106-21TD	05-107-21TD
23 cm / 9"	05-106-23T	05-107-23T	05-106-23TD	05-107-23TD
	0,8 x 6,0 mm	0,8 x 6,0 mm	0,8 x 6,0 mm	0,8 x 6,0 mm
12 cm 4¾"	05-104-12T	05-105-12T	05-104-12TD	05-105-12TD
15 cm / 6"	05-104-15T	05-105-15T	05-104-15TD	05-105-15TD
18 cm / 7"	05-104-18T	05-105-18T	05-104-18TD	05-105-18TD
21 cm / 8 1/4"	05-104-21T	05-105-21T	05-104-21TD	05-105-21TD
23 cm / 9"	05-104-23T	05-105-23T	05-104-21TD	05-105-23TD





Mikro Pinzette Rundgriff Titan
Micro Forceps Round Handle Titan
Микро пинцет круглая ручка Титан

Mikro Ring/ Micro Ring/микро колечко Mit Führungsstift/ with guide pin/ с направляющим штифтом				
	Glatte Maulteile / smooth Jaws / гладкие губки		Wolfram-Karbid-Beschichtung /Wolfram Carbide Tip Coating/Покрытие карбид вольфрама	
				
	1,0 x 0,5 mm	1,0 x 0,5 mm	1,0 x 0,5 mm	1,0 x 0,5 mm
12 cm 4¾"	05-120-12T	05-120-12TG	05-120-12TD	05-120-12TD
15 cm / 6"	05-120-15T	05-120-15TG	05-120-15TD	05-120-15TD
18 cm / 7"	05-11180-18	05-11185-18	05-11660-18	05-11665-18
21 cm / 8 1/4"	05-11180-21	05-11185-21	05-11660-21	05-11665-21
23 cm / 9"	05-120-23T	05-120-23TG	05-120-23TD	05-120-23TDG
	2,0 x 1,0 mm	2,0 x 1,0 mm	2,0 x 1,0 mm	2,0 x 1,0 mm
12 cm 4¾"	05-122-12T	05-122-12TG	05-122-12TD	05-122-12TDG
15 cm / 6"	05-122-15T	05-122-15TG	05-122-15TD	05-122-15TDG
18 cm / 7"	05-122-18T	05-122-18TG	05-122-18TD	05-122-18TDG
21 cm / 8 1/4"	05-122-21T	05-122-21TG	05-122-21TD	05-122-21TDG
23 cm / 9"	05-122-23T	05-122-23TG	05-122-23TD	05-122-23TDG



Mikro Ring/ Micro Ring/микро колечко Mit Führungsstift/ with guide pin/ с направляющим штифтом		
	Fein gerieft/ fine serrated/ с тонкой насечкой	
		
	1,0 x 0,5 mm	1,0 x 0,5 mm
12 cm 4¾"	05-121-12T	05-121-12TG
15 cm / 6"	05-121-15T	05-121-15TG
18 cm / 7"	05-121-18T	05-121-18TG
21 cm / 8 1/4"	05-121-21T	05-121-21TG
23 cm / 9"	05-121-23T	05-121-23TG
	2,0 x 1,0 mm	2,0 x 1,0 mm
12 cm 4¾"	05-123-12T	05-123-12TG
15 cm / 6"	05-123-15T	05-123-15TG
18 cm / 7"	05-123-18T	05-123-18TG
21 cm / 8 1/4"	05-123-21T	05-123-21TG
23 cm / 9"	05-123-23T	05-123-23TG



Mikro Pinzette Rundgriff Titan
Micro Forceps Round Handle Titan
Микро пинцет круглая ручка Титан



Mikro Ring/ Micro Ring/микро колечко
Mit Führungsstift/ with guide pin/ с
направляющим штифтом
Mit Fadenplatte / with tying platform / с
платформой для завязывания нитей

	Wolfram-Karbid-Beschichtung /Wolfram Carbide Tip Coating/Покрытие карбид вольфрама	
		
	1,0 x 0,5 mm	2,0 x 1,0 mm
12 cm 4 ³ / ₄ "	05-125-12TD	05-127-12TD
15 cm / 6"	05-125-15TD	05-127-15TD
18 cm / 7"	05-125-18TD	05-127-18TD
21 cm / 8 1/4"	05-125-21TD	05-127-21TD
23 cm / 9"	05-125-23TD	05-127-23TD

Mikro-Ring-Pinzette, Ø 9 mm
Micro Ring Forceps, Ø 9 mm
Микро Пинцет с колечком Ø 9 мм







Mit Führungsstopstift 1,5 mm, Ring geöffnet / with guide and stop in 1,5 mm, ring
opened / с направляющим Stop-штифтом 1,5 mm, колечко открыто

	Glatte Maulteile / smooth Jaws / гладкие губки		Wolfram-Karbid- Beschichtung /Wolfram Carbide Tip Coating/Покрытие карбид вольфрама	
				
	2,0 x 1,0 mm	2,0 x 1,0 mm	2,0 x 1,0 mm	2,0 x 1,0 mm
15 cm / 6"	05-9055-15	05-9054-15	05-9055-15D	05-9054-15D



Mikro Knüpf-Pinzette
Micro Suture Forceps
Пинцет с платформой для завязывания нитей

Mit Führungsstopstift, mit Fadenplatte / with guide and stop in, with tying platform
/ с направляющим и стоп-штифтом, с платформой для завязывания нитей

	Glatte Maulteile / smooth Jaws / гладкие губки		Wolfram-Karbid- Beschichtung / Wolfram Carbide Tip Coating/Покрытие карбид вольфрама	
				
	0,3 x 6,0 mm	0,3 x 6,0 mm	0,3 x 6,0 mm	0,3 x 6,0 mm
12 cm 4 ³ / ₄ "	05-9010-12	05-9011-12	05-9010-12D	05-9011-12D
14 cm 5 ³ / ₄ "	05-9010-14	05-9011-14	05-9010-14D	05-9011-14D
15 cm / 6"	05-9020-15	05-9011-15	05-9010-15D	05-9011-15D
	0,4 x 6,0 mm	0,4 x 6,0 mm	0,4 x 6,0 mm	0,4 x 6,0 mm
18 cm / 7"	05-9030-18	05-9031-18	05-9030-18D	05-9031-18D
21 cm / 8 1/4"	05-9030-21	05-9031-21	05-9030-21D	05-9031-21D
23 cm / 9"	05-9030-23	05-9031-23	05-9030-23D	05-9031-23D
	0,4 x 7,0 mm	0,4 x 7,0 mm	0,4 x 7,0 mm	0,4 x 7,0 mm
18 cm / 7"	05-1683-18	05-1685-18	05-1703-18	05-1705-18
21 cm / 8 1/4"	05-1683-21	05-1685-21	05-1703-21	05-1705-21
23 cm / 9"	05-1683-23	05-1685-23	05-1703-23	05-1705-23
	0,7 x 7,0 mm	0,7 x 7,0 mm	0,7 x 7,0 mm	0,7 x 7,0 mm
18 cm / 7"	05-1680-18	05-1681-18	05-1700-18	05-1701-18
21 cm / 8 1/4"	05-1680-21	05-1681-21	05-1700-21	05-1701-21
23 cm / 9"	05-1680-23	05-1681-23	05-1700-23	05-1701-23
	0,8 x 6,0 mm	0,8 x 6,0 mm	0,8 x 6,0 mm	0,8 x 6,0 mm
18 cm / 7"	05-9034-18	05-9035-18	05-9034-18D	05-9035-18D
21 cm / 8 1/4"	05-9034-21	05-9035-21	05-9034-21D	05-9035-21D
23 cm / 9"	05-9034-23	05-9035-23	05-9034-23D	05-9035-23D

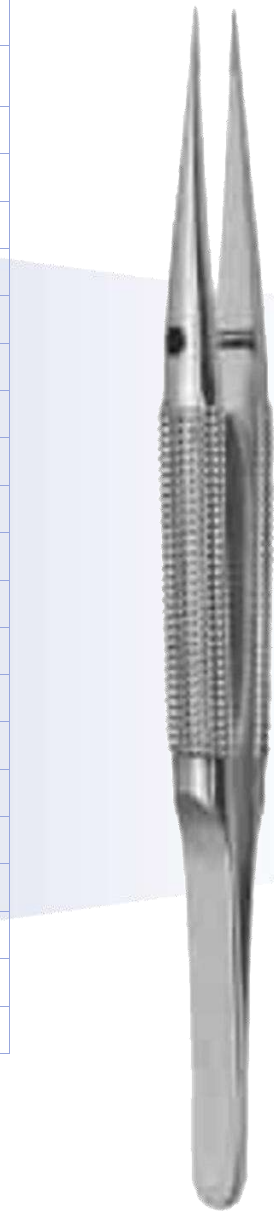



Mikro Knüpf-Pinzette
Micro Suture Forceps
Пинцет с платформой для завязывания нитей

Mit Führungsstopstift, mit Fadenplatte / with guide and stop in, with tying platform / с направляющим и Stop-штифтом, с платформой для завязывания нитей				
	Glatte Maulteile / smooth Jaws / гладкие губки		Wolfram-Karbid-Beschichtung / Wolfram Carbide Tip Coating / Покрытие карбид вольфрама	
1 x 2 Zähne/teeth/зубчики				
	0,3 x 6,0 mm	0,3 x 6,0 mm	0,3 x 6,0 mm	0,3 x 6,0 mm
12 cm / 4 ³ / ₄ "	05-9014-12	05-9015-12	05-9014-12D	05-9015-12D
14 cm / 5 ³ / ₄ "	05-9014-14	05-9015-14	05-9014-14D	05-9015-14D
15 cm / 6"	05-9014-15	05-9015-15	05-9014-15D	05-9015-15D
	0,4 x 6,0 mm	0,4 x 6,0 mm	0,4 x 6,0 mm	0,4 x 6,0 mm
18 cm / 7"	05-9040-18	05-9041-18	05-9040-18D	05-9041-18D
21 cm / 8 1/4"	05-9040-21	05-9041-21	05-9040-21D	05-9041-21D
23 cm / 9"	05-9040-23	05-9041-23	05-9040-23D	05-9041-23D
	0,8 x 6,0 mm	0,8 x 6,0 mm	0,8 x 6,0 mm	0,8 x 6,0 mm
18 cm / 7"	05-9044-18	05-9045-18	05-9044-18D	05-9045-18D
21 cm / 8 1/4"	05-9044-21	05-9045-21	05-9044-21D	05-9045-21D
23 cm / 9"	05-9044-23	05-9045-23	05-9044-23D	05-9045-23D

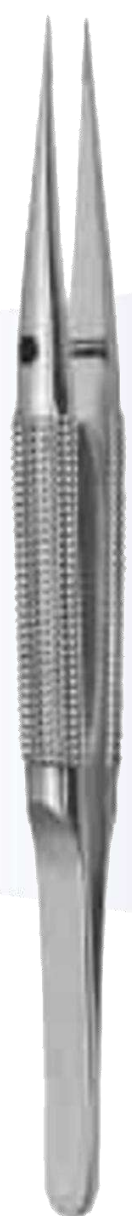

Mit Führungsstopstift, Mikro Ring / with guide and stop pin, Micro Ring / с направляющим и Stop-штифтом микро колечко

	Glatte Maulteile / smooth Jaws / гладкие губки	Fein gerieft / fine serrated / с тонкой насечкой	Wolfram-Karbid-Beschichtung / Wolfram Carbide Tip Coating / Покрытие карбид вольфрама
	1,0 x 0,5 mm	1,0 x 0,5 mm	1,0 x 0,5 mm
15 cm / 6"	05-9050-15	05-9051-15	05-9050-15D
18 cm / 7"	05-9050-18	05-9051-18	05-9050-18D
21 cm / 8 1/4"	05-9050-21	05-9051-21	05-9050-21D
23 cm / 9"	05-9050-23	05-9051-23	05-9050-23D
	2,0 x 1,0 mm	2,0 x 1,0 mm	2,0 x 1,0 mm
15 cm / 6"	05-9052-15	05-9053-15	05-9052-15D
18 cm / 7"	05-9052-18	05-9053-18	05-9052-18D
21 cm / 8 1/4"	05-9052-21	05-9053-21	05-9052-21D
23 cm / 9"	05-9052-23	05-9053-23	05-9052-23D

Mikro Pinzette – Rundgriff Ø 9 mm
Micro Forceps - Round Handle Ø 9 mm
Микро Пинцет - круглая ручка Ø 9 mm





Gefäßdilator, Ø 8 mm
Vessel Dilator, Ø 8 mm
Сосудистый дилатор, Ø 8 мм

Mit eingesetztem Maul/ Serrated Jaws/c заужеными губками		
		
12,5 cm/ 0,2 mm	05-9097-12	05-9098-12
12,5 cm/ 0,3 mm	05-9099-12	05-9100-12
12,5 cm/ 0,5 mm	05-9095-12	05-9096-12



Titan-Gefäßdilator, Ø 8 mm
Titanium Vessel Dilator, Ø 8 mm
Титановый сосудистый дилатор, Ø 8 мм

Mit eingesetztem Maul/ Serrated Jaws/c заужеными губками		
		
12,5 cm /0,2 mm	05-9097-12T	05-9098-12T
12,5 cm/ 0,3 mm	05-9099-12T	05-9100-12T
12,5 cm/ 0,5 mm	05-9095-12T	05-9096-12T





Glatte Maulteile/Smooth Jaws/ Гладкие губки mit Führungsstift Ø 1,0 mm/with guide pin Ø 1,0 mm/ с направляющим штифтом Ø 1,0 мм						
Glatte Maulteile/Smooth Jaws/ Гладкие губки						
	0,4 mm	0,4 mm	0,4 mm	0,9 mm	0,9 mm	0,9 mm
	Spitz/ sharp/ острые	Spitz/ sharp/ острые	Spitz/ sharp/ острые	Stumpf/blunt/ тупые	Stumpf/blunt/ тупые	Stumpf/blunt/ тупые
21 cm / 8 1/4"	05-9240-21	05-9245-21	05-9247-21	05-9241-21	05-9246-21	05-9248-21
23 cm / 9"	05-9240-23	05-9245-23	05-9247-23	05-9241-23	05-9246-23	05-9248-23
25 cm/10"	05-9240-25	05-9245-25	05-9247-25	05-9241-25	05-9246-25	05-9248-25
Wolfram-Karbid-Beschichtung /Wolfram Carbide Tip Coating/Покрытие карбид вольфрама						
	0,4 mm	0,4 mm	0,4 mm	0,9 mm	0,9 mm	0,9 mm
	Spitz/ sharp/ острые	Spitz/ sharp/ острые	Spitz/ sharp/ острые	Stumpf/blunt/ тупые	Stumpf/blunt/ тупые	Stumpf/blunt/ тупые
21 cm 8 1/4"	05-9240-21D	05-9245-21D	05-9247-21D	05-9241-21D	05-9246-21D	05-9248-21D
23 cm / 9"	05-9240-23D	05-9245-23D	05-9247-23D	05-9241-23D	05-9246-23D	05-9248-23D
25 cm/10"	05-9240-25D	05-9245-25D	05-9247-25D	05-9241-25D	05-9246-25D	05-9248-25D



Mikro Ring/ Micro Ring/микро колечко mit Führungsstift Ø 1,0 mm/with guide pin Ø 1,0 mm/ с направляющим штифтом Ø 1,0 мм			
	Glatte Maulteile / smooth Jaws / гладкие губки	Maul gerieft/Jaws serrated/Губки рифленые/Jaws serrated/Губки рифленые	Wolfram- Karbid- Beschichtung /Wolfram Carbide Tip Coating/Покры- тие карбид вольфрама
	Ø 1,0 x 0,5 mm	Ø 1,0 x 0,5 mm	Ø 1,0 x 0,5 mm
21 cm / 8 1/4"	05-9250-21	05-9251-21	05-9250-21D
23 cm / 9"	05-9250-23	05-9251-23	05-9250-23D
25 cm/10"	05-9250-25	05-9251-25	05-9250-25D
	Ø 2,0 x 1,0 mm	Ø 2,0 x 1,0 mm	Ø 2,0 x 1,0 mm
21 cm / 8 1/4"	05-9252-21	05-9253-21	05-9252-21D
23 cm / 9"	05-9252-23	05-9253-23	05-9252-23D
25 cm/10"	05-9252-25	05-9253-25	05-9252-25D



Mikro-Pinzetten – Rundgriff – Titan
Micro Forceps - Round Handle – Titanium
Микро Пинцет - Круглая ручка Титан

Mit Führungsstift/ with guide pin/ с направляющим штифтом				
Glatte Maulteile/Smooth Jaws/ Гладкие губки				
	Spitz/ sharp/ острые	Spitz/ sharp/ острые	Stumpf/blunt/ тупые	Stumpf/blunt/ тупые
	0,4 mm	0,4 mm	0,9 mm	0,9 mm
21 cm / 8 1/4"	05-190-21T	05-192-21T	05-191-21T	05-193-21T
23 cm / 9"	05-190-23T	05-192-23T	05-191-23T	05-193-23T
25 cm / 10"	05-190-25T	05-192-25T	05-191-25T	05-193-25T
Wolfram-Karbid-Beschichtung /Wolfram Carbide Tip Coating/Покрытие карбид вольфрама				
	Spitz/ sharp/ острые	Spitz/ sharp/ острые	Stumpf/blunt/ тупые	Stumpf/blunt/ тупые
	0,4 mm	0,4 mm	0,9 mm	0,9 mm
21 cm / 8 1/4"	05-190-21TD	05-192-21TD	05-191-21TD	05-193-21TD
23 cm / 9"	05-190-23TD	05-192-23TD	05-191-23TD	05-193-23TD
25 cm / 10"	05-190-25TD	05-192-25TD	05-191-25TD	05-193-25TD





Mikro Ring/ Micro Ring/микро колечко Mit Führungsstift/ with guide pin/ с направляющим штифтом			
	Glatte Maulteile / smooth Jaws / гладкие губки	Fein gerieft/ fine serrated/ с тонкой насечкой	Wolfram- Karbid- Beschichtung /Wolfram Carbide Tip Coating/Покр ытие карбид вольфрама
	1,0 x 0,5 mm	1,0 x 0,5 mm	1,0 x 0,5 mm
21 cm / 8 1/4"	05-195-21T	05-196-21TD	05-195-21TD
23 cm / 9"	05-195-23T	05-196-23TD	05-195-23TD
25 cm / 10"	05-195-25T	05-196-25TD	05-195-25TD
	2,0 x 1,0 mm	2,0 x 1,0 mm	2,0 x 1,0 mm
21 cm / 8 1/4"	05-197-21T	05-198-21T	05-197-21TD
23 cm / 9"	05-197-23T	05-197-23T	05-197-23T
25 cm / 10"	05-197-25T	05-197-25T	05-197-25T











Mikro Pinzette mit Gegengewicht
Micro Forceps with counterweight
Микропинцет с противовесом



De BAKEY				
Mit Führungsstift/ with guide pin/ с направляющим штифтом				
ATRAUMA DE BAKEY				
	1,2 mm	1,2 mm	2,0 mm	2,0 mm
15 cm / 6"	05-1808-15	05-1809-15	05-9186-15	05-9188-15
18 cm / 7"	05-1808-18	05-1809-18	05-9186-18	05-9188-18
21 cm / 8 1/4"	05-1808-21	05-1809-21	05-9186-21	05-9188-21
23 cm / 9"	05-1808-23	05-1809-23	05-9186-23	05-9188-23
25 cm / 9 3/4"	05-1808-25	05-1809-25	05-9186-25	05-9188-25



Mit Führungsstift/ with guide pin/ с направляющим штифтом						
	Glatte Maulteile / smooth Jaws / гладкие губки			Wolfram-Karbid-Beschichtung / Wolfram Carbide Tip Coating / Покрытие карбид вольфрама		
						
	0,3 mm	0,3 mm	0,3 mm	0,3 mm	0,3 mm	0,3 mm
15 cm / 6"	05-9170-15	05-9171-15	05-9175-15A	05-9170-15D	05-9171-15D	05-9175-15AD
18 cm / 7"	05-9170-18	05-9171-18	05-9175-18A	05-9170-18D	05-9171-18D	05-9175-18AD
21 cm / 8 1/4"	05-9170-21	05-9171-21		05-9170-21D	05-9171-21D	
23 cm / 9"	05-9170-23	05-9171-23		05-9170-23D	05-9171-23D	
25 cm / 9 3/4"	05-9170-25	05-9171-25		05-9170-25D	05-9171-25D	
	0,7 mm	0,7 mm		0,7 mm	0,7 mm	
15 cm / 6"	05-9172-15	05-9173-15		05-9172-15D	05-9173-15D	
18 cm / 7"	05-9172-18	05-9173-18		05-9172-18D	05-9173-18D	
21 cm / 8 1/4"	05-9172-21	05-9173-21		05-9172-21D	05-9173-21D	
23 cm / 9"	05-9172-23	05-9173-23		05-9172-23D	05-9173-23D	
25 cm / 9 3/4"	05-9172-25	05-9173-25		05-9172-25D	05-9173-25D	



Mikro Pinzette mit Gegengewicht
Micro Forceps with counterweight
Микропинцет с противовесом

Mit Fadenplatte / with tying platform / с платформой для завязывания нитей
Mit Führungsstift/ with guide pin/ с направляющим штифтом





	Glatte Maulteile / smooth Jaws / гладкие губки		Wolfram-Karbid-Beschichtung /Wolfram Carbide Tip Coating/Покрытие карбид вольфрама	
	0,3 x 6,0 mm	0,3 x 6,0 mm	0,3 x 6,0 mm	0,3 x 6,0 mm
15 cm / 6"	05-9174-15	05-9175-15	05-9174-15D	05-9175-15D
18 cm / 7"	05-9174-18	05-9175-18	05-9174-18D	05-9175-18D
21 cm / 8 1/4"	05-9174-21	05-9175-21	05-9174-21D	05-9175-21D
23 cm / 9"	05-9174-23	05-9175-23	05-9174-23D	05-9175-23D
25 cm / 9 3/4"	05-9174-24	05-9175-25	05-9174-24D	05-9175-25D
1 x 2 Zähne/teeth/ зубчики				
15 cm / 6"	05-9178-15.03	05-9179-15.03	05-9178-15.03D	05-9179-15.03D
18 cm / 7"	05-9178-18.03	05-9178-18.03	05-9178-18.03D	05-9178-18.03D
21 cm / 8 1/4"	05-9178-21.03	05-9178-21.03	05-9178-21.03D	05-9178-21.03D
23 cm / 9"	05-9178-23.03	05-9178-23.03	05-9178-23.03D	05-9178-23.03D
25 cm / 9 3/4"	05-9178-25.03	05-9178-25.03	05-9178-25.03D	05-9178-25.03D
	0,7 x 6,0 mm	0,7 x 6,0 mm	0,7 x 6,0 mm	0,7 x 6,0 mm
15 cm / 6"	05-9176-15	05-9177-15	05-9174-15D	05-9175-15D
18 cm / 7"	05-9176-18	05-9177-18	05-9174-18D	05-9175-18D
21 cm / 8 1/4"	05-9176-21	05-9177-21	05-9174-21D	05-9175-21D
23 cm / 9"	05-9176-23	05-9177-23	05-9174-23D	05-9175-23D
25 cm / 9 3/4"	05-9176-24	05-9177-25	05-9174-24D	05-9175-25D
1 x 2 Zähne/teeth/ зубчики				
15 cm / 6"	05-9178-15	05-9179-15	05-9178-15D	05-9179-15D
18 cm / 7"	05-9178-18	05-9178-18	05-9178-18D	05-9178-18D
21 cm / 8 1/4"	05-9178-21	05-9178-21	05-9178-21D	05-9178-21D
23 cm / 9"	05-9178-23	05-9178-23	05-9178-23D	05-9178-23D
25 cm / 9 3/4"	05-9178-25	05-9178-25	05-9178-25D	05-9178-25D





Mikro Pinzette mit Gegengewicht
Micro Forceps with counterweight
Микропинцет с противовесом















Mit Fadenplatte / with tying platform / с платформой для завязывания нитей
Mit Führungsstift/ with guide pin/ с направляющим штифтом

	Glatte Maulteile / smooth Jaws / гладкие губки		Wolfram-Karbid- Beschichtung /Wolfram Carbide Tip Coating/Покрытие карбид вольфрама	
				
	0,4 x 7,0 mm	0,4 x 7,0 mm	0,4 x 7,0 mm	0,4 x 7,0 mm
15 cm / 6"	05-1882-15	05-1883-15	05-1782-15	05-1783-15
18 cm / 7"	05-1882-18	05-1883-18	05-1782-18	05-1783-18
21 cm / 8 1/4"	05-1882-21	05-1883-21	05-1782-21	05-1783-21
23 cm / 9"	05-1882-23	05-1883-23	05-1782-23	05-1783-23
25 cm / 9 3/4"	05-1882-25	05-1883-25	05-1782-25	05-1782-25
	0,7 x 7,0 mm	0,7 x 7,0 mm	0,7 x 7,0 mm	0,7 x 7,0 mm
15 cm / 6"	05-1887-15	05-1899-15	05-1787-25	05-1799-15
18 cm / 7"	05-1887-18	05-1899-18	05-1787-18	05-1799-18
21 cm / 8 1/4"	05-1887-21	05-1899-21	05-1787-21	05-1799-21
23 cm / 9"	05-1887-23	05-1899-23	05-1787-23	05-1799-23
25 cm / 9 3/4"	05-1887-25	05-1899-25	05-1787-25	05-1799-25



Mikro Pinzette mit Gegengewicht
Micro Forceps with counterweight
Микропинцет с противовесом

Mikro Ring/ Micro Ring/микро колечко
Mit Führungsstift/ with guide pin/ с направляющим штифтом

	Glatte Maulteile / smooth Jaws / гладкие губки		Fein gerieft/ fine serrated/ с тонкой насечкой		Wolfram-Karbid-Beschichtung /Wolfram Carbide Tip Coating/Покрытие карбид вольфрама	
	1,0 x 0,5 mm	1,0 x 0,5 mm	1,0 x 0,5 mm	1,0 x 0,5 mm	1,0 x 0,5 mm	1,0 x 0,5 mm
						
15 cm / 6"	05-1892-15	05-1893-15	05-9181-15	05-9181-15G	05-1792-15	05-1793-15
18 cm / 7"	05-1892-18	05-1893-18	05-9181-18	05-9181-18G	05-1792-18	05-1793-18
21 cm / 8 1/4"	05-1892-21	05-1893-21	05-9181-21	05-9181-21G	05-1792-21	05-1793-21
23 cm / 9"	05-1892-23	05-1893-23	05-9181-23	05-9181-23G	05-1792-23	05-1793-23
25 cm / 9 3/4"	05-1892-25	05-1893-25	05-9181-25	05-9181-25G	05-1792-25	05-1793-25
					2,0 x 0,8 mm	2,0 x 0,8 mm
						
18 cm / 7"					05-1791-18	05-1795-18
	2,0 x 1,0 mm	2,0 x 1,0 mm	2,0 x 1,0 mm	2,0 x 1,0 mm	2,0 x 1,0 mm	2,0 x 1,0 mm
						
15 cm / 6"	05-9182-15	05-9182-15G	05-9183-15	05-9183-15G	05-9182-15D	05-9182-15GD
18 cm / 7"	05-9182-18	05-9182-18G	05-9183-18	05-9183-18G	05-9182-18D	05-9182-18GD
21 cm / 8 1/4"	05-9182-21	05-9182-21G	05-9183-21	05-9183-21G	05-9182-21D	05-9182-21GD
23 cm / 9"	05-9182-23	05-9182-23G	05-9183-23	05-9183-23G	05-9182-23D	05-9182-23GD
25 cm / 9 3/4"	05-9182-25	05-9182-25G	05-9183-25	05-9183-25G	05-9182-25D	05-9182-25GD





Mikro Pinzette mit Gegengewicht
Micro Forceps with counterweight
Микропинцет с противовесом

Mikro Ring/ Micro Ring/микро колечко
Mit Fadenplatte / with tying platform / с
платформой для завязывания нитей
Mit Führungsstift/ with guide pin/ с
направляющим штифтом

Wolfram-Karbid-Beschichtung
/Wolfram Carbide Tip
Coating/Покрытие карбид
вольфрама



1,0 x 0,5 mm



2,0 x 1,0 mm

15 cm / 6"	05-9185-15D	05-9187-15D
18 cm / 7"	05-9185-18D	05-9187-18D
21 cm / 8 1/4"	05-9185-21D	05-9187-21D
23 cm / 9"	05-9185-23D	05-9187-23D
25 cm / 9 3/4"	05-9185-25D	05-9187-25D

PIERSE

Mit Führungsstift/ with guide pin / с
направляющим штифтом



0,3 mm

Ø 0,4 mm

15 cm / 6"	05-9170-15P	05-1786-15
18 cm / 7"	05-9170-18P	05-1786-18

Mit eingesetztem Maul/ Serrated
Jaws/с зауженными губками



Ø 0,3 mm

15 cm / 6"	05-1784-15
18 cm / 7"	05-1784-18





Titan-Mikro-Gewicht-Pinzette, Ø 9 mm
Titanium Micro Forceps, counterweight, Ø 9 mm
Титановый микропинцет с противовесом Ø 9 mm

De BAKEY				
Mit Führungsstift/ with guide pin/ с направляющим штифтом				
ATRAUMA DE BAKEY				
	1,2 mm	1,2 mm	1,8 mm	1,8 mm
15 cm / 6"	05-230-15T	05-231-15T	05-232-15T	05-233-15T
18 cm / 7"	05-230-18T	05-231-18T	05-232-18T	05-233-18T
21 cm / 8 1/4"	05-230-21T	05-231-21T	05-232-21T	05-233-21T
23 cm / 9"	05-230-23T	05-231-23T	05-232-23T	05-233-23T
25 cm / 9 3/4"	05-230-25T	05-231-25T	05-232-25T	05-233-25T

Mit Führungsstift/ with guide pin/ с направляющим штифтом				
	Glatte Maulteile / smooth Jaws / гладкие губки		Wolfram-Karbid-Beschichtung /Wolfram Carbide Tip Coating/Покрытие карбид вольфрама	
	0,4 mm	0,4 mm	0,4 mm	0,4 mm
15 cm / 6"	05-212-15T	05-213-15T	05-212-15TD	05-213-15TD
18 cm / 7"	05-212-18T	05-213-18T	05-212-18TD	05-213-18TD
21 cm / 8 1/4"	05-212-21T	05-213-21T	05-212-21TD	05-213-21TD
23 cm / 9"	05-212-23T	05-213-23T	05-212-23TD	05-213-23TD
25 cm / 9 3/4"	05-212-25T	05-213-25T	05-212-25TD	05-213-25TD
	0,8 mm	0,8 mm	0,8 mm	0,8 mm
15 cm / 6"	05-210-15T	05-211-15T	05-210-15TD	05-211-15TD
18 cm / 7"	05-210-18T	05-211-18T	05-210-18TD	05-211-18TD
21 cm / 8 1/4"	05-210-21T	05-211-21T	05-210-21TD	05-211-21TD
23 cm / 9"	05-210-23T	05-211-23T	05-210-23TD	05-211-23TD
25 cm / 9 3/4"	05-210-25T	05-211-25T	05-210-25TD	05-211-25TD





Titan-Mikro-Gewicht-Pinzette, Ø 9 mm
Titanium Micro Forceps, counterweight, Ø 9 mm
Титановый микропинцет с противовесом Ø 9 mm

Mit Fadenplatte / with tying platform / с платформой для завязывания нитей
 Mit Führungsstift/ with guide pin/ с направляющим штифтом

	Glatte Maulteile / smooth Jaws / гладкие губки		Wolfram-Karbid-Beschichtung /Wolfram Carbide Tip Coating/Покрyтие карбид вольфрама	
				
	0,4 x 6,0 mm	0,4 x 6,0 mm	0,4 x 6,0 mm	0,4 x 6,0 mm
15 cm / 6"	05-202-15T	05-203-15T	05-202-15TD	05-203-15TD
18 cm / 7"	05-202-18T	05-203-18T	05-202-18TD	05-203-18TD
21 cm / 8 1/4"	05-202-21T	05-203-21T	05-202-21TD	05-203-21TD
23 cm / 9"	05-202-23T	05-203-23T	05-202-23TD	05-203-23TD
25 cm / 9 3/4"	05-202-25T	05-203-25T	05-202-25TD	05-203-25TD
1 x 2 Zähne/teeth/ зубчики				
15 cm / 6"	05-206-15T	05-207-15T	05-206-15TD	05-207-15TD
18 cm / 7"	05-206-18T	05-207-18T	05-206-18TD	05-207-18TD
21 cm / 8 1/4"	05-206-21T	05-207-21T	05-206-21TD	05-207-21TD
23 cm / 9"	05-206-23T	05-207-23T	05-206-23TD	05-207-23TD
25 cm / 9 3/4"	05-206-25T	05-207-25T	05-206-25TD	05-207-25TD
				
	0,8 x 6,0 mm	0,8 x 6,0 mm	0,8 x 6,0 mm	0,8 x 6,0 mm
15 cm / 6"	05-200-15T	05-201-15T	05-200-15TD	05-201-15TD
18 cm / 7"	05-200-18T	05-201-18T	05-200-18TD	05-201-18TD
21 cm / 8 1/4"	05-200-21T	05-201-21T	05-200-21TD	05-201-21TD
23 cm / 9"	05-200-23T	05-201-23T	05-200-23TD	05-201-23TD
25 cm / 9 3/4"	05-200-23T	05-201-23T	05-200-23TD	05-201-23TD
1 x 2 Zähne/teeth/ зубчики				
15 cm / 6"	05-204-15T	05-205-15T	05-204-15TD	05-205-15TD
18 cm / 7"	05-204-18T	05-205-18T	05-204-18TD	05-205-18TD
21 cm / 8 1/4"	05-204-21T	05-205-21T	05-204-21TD	05-205-21TD
23 cm / 9"	05-204-23T	05-205-23T	05-204-23TD	05-205-23TD
25 cm / 9 3/4"	05-204-23T	05-205-23T	05-204-23TD	05-205-23TD

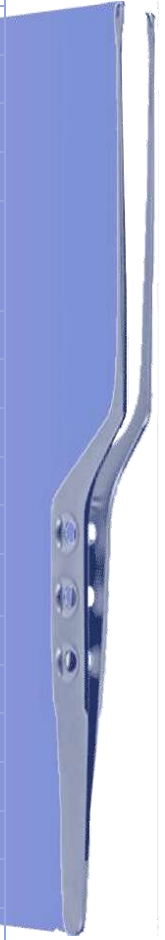



Titan-Mikro-Gewicht-Pinzette, Ø 9 mm
Titanium Micro Forceps, counterweight, Ø 9 mm
Титановый микропинцет с противовесом Ø 9 mm

Mikro Ring/ Micro Ring/микро колечко Mit Führungsstift/ with guide pin/ с направляющим штифтом						
	Glatte Maulteile / smooth Jaws / гладкие губки		Fein gerieft/ fine serrated/ с тонкой насечкой		Wolfram-Karbid-Beschichtung /Wolfram Carbide Tip Coating/Покрытие карбид вольфрама	
	1,0 x 0,5 mm	1,0 x 0,5 mm	1,0 x 0,5 mm	1,0 x 0,5 mm	1,0 x 0,5 mm	1,0 x 0,5 mm
15 cm / 6"	05-220-15T	05-220-15TG	05-221-15T	05-221-15TG	05-220-15TD	05-220-15TGD
18 cm / 7"	05-220-18T	05-220-18TG	05-221-18T	05-221-18TG	05-220-18TD	05-220-18TGD
21 cm / 8 1/4"	05-220-21T	05-220-21TG	05-221-21T	05-221-21TG	05-220-21TD	05-220-21TGD
23 cm / 9"	05-220-23T	05-220-23TG	05-221-23T	05-221-23TG	05-220-23TD	05-220-23TGD
25 cm / 9 3/4"	05-220-23T	05-220-23TG	05-221-23T	05-221-23TG	05-220-23TD	05-220-23TGD
	2,0 x 1,0 mm	2,0 x 1,0 mm	2,0 x 1,0 mm	2,0 x 1,0 mm	2,0 x 1,0 mm	2,0 x 1,0 mm
15 cm / 6"	05-222-15T	05-222-15TG	05-223-15T	05-223-15TG	05-222-15TD	05-222-15TGD
18 cm / 7"	05-222-18T	05-222-18TG	05-223-18T	05-223-18TG	05-222-18TD	05-222-18TGD
21 cm / 8 1/4"	05-222-21T	05-222-21TG	05-223-21T	05-223-21TG	05-222-21TD	05-222-21TGD
23 cm / 9"	05-222-23T	05-222-23TG	05-223-23T	05-223-23TG	05-222-23TD	05-222-23TGD
25 cm / 9 3/4"	05-222-23T	05-222-23TG	05-223-23T	05-223-23TG	05-222-23TD	05-222-23TGD

Mikro Ring/ Micro Ring/микро колечко
Mit Fadenplatte 10 mm / with tying platform 10 mm/
с платформой для завязывания нитей 10 mm
Mit Führungsstift/ with guide pin/ с направляющим
штифтом









	Wolfram-Karbid-Beschichtung /Wolfram Carbide Tip Coating/Покрытие карбид вольфрама	
	1,0 x 0,5 mm	2,0 x 1,0 mm
15 cm / 6"	05-225-15TD	05-227-15TD
18 cm / 7"	05-225-18TD	05-227-18TD
21 cm / 8 1/4"	05-225-21TD	05-227-21TD
23 cm / 9"	05-225-23TD	05-227-23TD
25 cm / 9 3/4"	05-225-25TD	05-227-25TD





Mikro Pinzetten Rundgriff
Micro Forceps Round Handle
Микро пинцет круглая ручка



Mit Fadenplatte / with tying platform / с платформой для завязывания нитей

	Glatte Maulteile / smooth Jaws / гладкие губки		Wolfram-Karbid-Beschichtung / Wolfram Carbide Tip Coating / Покрытие карбид вольфрама	
				
	0,4 x 7,0 mm	0,4 x 7,0 mm	0,4 x 7,0 mm	0,4 x 7,0 mm
15 cm / 6"	05-1880-15	05-1881-15	05-1780-15	05-1781-15
18 cm / 7"	05-1880-18	05-1881-18	05-1780-18	05-1781-18
21 cm / 8 1/4"	05-1880-21	05-1881-21	05-1780-21	05-1781-21
				
	0,7 x 7,0 mm	0,7 x 7,0 mm	0,7 x 7,0 mm	0,7 x 7,0 mm
15 cm / 6"	05-1860-15	05-1861-15	05-1760-15	05-1761-15
18 cm / 7"	05-1860-18	05-1861-18	05-1760-18	05-1761-18
21 cm / 8 1/4"	05-1860-21	05-1861-21	05-1760-21	05-1761-21

1 x 2 Zähne/teeth/ зубчики

				
				
	Ø 0,4 mm	Ø 0,4 mm	Ø 0,7 mm	Ø 0,7 mm
15 cm / 6"	05-1810-15	05-1811-15	05-1812-15	05-1813-15
18 cm / 7"	05-1810-18	05-1811-18	05-1812-18	05-1813-18
21 cm / 8 1/4"	05-1810-21	05-1811-21	05-1812-21	05-1813-21



De BAKEY

		
	1,2 mm	1,2 mm
15 cm / 6"	05-1800-15	05-1803-15
18 cm / 7"	05-1800-18	05-1803-18
21 cm / 8 1/4"	05-1800-21	05-1803-21







Mikro Pinzette – Rundgriff
Micro Forceps - Round Handle
Микро Пинцет - Круглая ручка

Mikro Ring/ Micro Ring/микро колечко Ø 1,0 x 0,5 mm		
	Glatte Maulteile / smooth Jaws / гладкие губки	Wolfram-Karbid- Beschichtung /Wolfram Carbide Tip Coating/Покр ытие карбид вольфрама
		
	Ø 1,0 x 0,5 mm	Ø 1,0 x 0,5 mm
15 cm / 6"	05-1890-15	05-1790-15
18 cm / 7"	05-1890-18	05-1790-18
21 cm / 8 1/4"	05-1890-21	05-1790-21



Micro-Pinzetten –Design-Griff
Micro Forceps - Design handle
Микро Пинцет - Design ручка

De BAKEY Mit Führungsstift/ with guide pin/ с направляющим штифтом				
ATRAUMA DE BAKEY				
	1,2 mm	1,2 mm	2,0 mm	2,0 mm
12 cm/4 3/4"	05-9085-12B	05-9087-12B	05-9086-12B	05-9088-12B
15 cm / 6"	05-9085-15B	05-9087-15B	05-9086-15B	05-9088-15B
18 cm / 7"	05-1190-18T	05-1195-18T	05-9086-18B	05-9088-18B
21 cm / 8 1/4"	05-1190-21T	05-1195-21T	05-9086-21B	05-9088-21B
23 cm / 9"	05-9085-23B	05-9087-23B	05-9086-23B	05-9088-23B













Mit Führungsstift/ with guide pin / с направляющим штифтом						
	Glatte Maulteile / smooth Jaws / гладкие губки			Wolfram-Karbid-Beschichtung /Wolfram Carbide Tip Coating/Покрытие карбид вольфрама		
	0,3 mm	0,3 mm	0,3 mm	0,3 mm	0,3 mm	0,3 mm
12 cm/4 3/4"	05-9070-12B	05-9071-12B	05-9075-12BA	05-9070-12BD	05-9071-12BD	05-9075-12BAD
15 cm / 6"	05-9070-15B	05-9071-15B	05-9075-15BA	05-9070-15BD	05-9071-15BD	05-9075-15BAD
18 cm / 7"	05-9070-18B	05-9071-18B	05-9075-18BA	05-9070-18BD	05-9071-18BD	05-9075-18BAD
21 cm / 8 1/4"	05-9070-21B	05-9071-21B		05-9070-21BD	05-9071-21BD	
23 cm / 9"	05-9070-23B	05-9071-23B		05-9070-23BD	05-9071-23BD	
	0,7 mm	0,7 mm		0,7 mm	0,7 mm	
12 cm/4 3/4"	05-9072-12B	05-9073-12B		05-9072-12BD	05-9073-12BD	
15 cm / 6"	05-9072-15B	05-9073-15B		05-9072-15BD	05-9073-15BD	
18 cm / 7"	05-9072-18B	05-9073-18B		05-9072-18BD	05-9073-18BD	
21 cm / 8 1/4"	05-9072-21B	05-9073-21B		05-9072-21BD	05-9073-21BD	
23 cm / 9"	05-9072-23B	05-9073-23B		05-9072-23BD	05-9073-23BD	

PIERSE	
Mit Führungsstift/ with guide pin / с направляющим штифтом	
	Ø 0,3 mm
12 cm/4 3/4"	05-9070-12BP
15 cm / 6"	05-9070-15BP
18 cm / 7"	05-9070-18BP



Micro-Pinzetten –Design-Griff
Micro Forceps - Design handle
Micro Пинцет - Design ручка

Mit Führungsstift, Fadenplatte / with guide pin, tying platform / с направляющим штифтом, платформа для завязывания нитей				
	Glatte Maulteile / smooth Jaws / гладкие губки		Wolfram-Karbid-Beschichtung / Wolfram Carbide Tip Coating / Покрытие карбид вольфрама	
				
	0,3 x 6,0 mm	0,3 x 6,0 mm	0,3 x 6,0 mm	0,3 x 6,0 mm
12 cm / 4 3/4"	05-9074-12B	05-9075-12B	05-9074-12BD	05-9075-12BD
15 cm / 6"	05-9074-15B	05-9075-15B	05-9074-15BD	05-9075-15BD
18 cm / 7"	05-9074-18B	05-9075-18B	05-9074-18BD	05-9075-18BD
21 cm / 8 1/4"	05-9074-21B	05-9075-21B	05-9074-21BD	05-9075-21BD
23 cm / 9"	05-9074-23B	05-9075-23B	05-9074-23BD	05-9075-23BD
	0,4 x 7,0 mm	0,4 x 7,0 mm	0,4 x 7,0 mm	0,4 x 7,0 mm
15 cm / 6"	05-1170-15T	05-1175-15T	05-1580-15T	05-1585-15T
18 cm / 7"	05-1170-18T	05-1175-18T	05-1580-18T	05-1585-18T
21 cm / 8 1/4"	05-1170-21T	05-1175-21T	05-1580-21T	05-1585-21T
23 cm / 9"	05-1170-23T	05-1175-23T	05-1580-23T	05-1585-23T
	0,7 x 7,0 mm	0,7 x 7,0 mm	0,7 x 7,0 mm	0,7 x 7,0 mm
12 cm / 4 3/4"	05-9076-12B	05-9077-12B	05-9076-12BD	05-9077-12BD
15 cm / 6"	05-1171-15T	05-1176-15T	05-1581-15T	05-1586-15T
18 cm / 7"	05-1171-18T	05-1176-18T	05-1581-18T	05-1586-18T
21 cm / 8 1/4"	05-1171-21T	05-1176-21T	05-1581-21T	05-1586-21T
23 cm / 9"	05-1171-23T	05-1176-23T	05-1581-23T	05-1586-23T

1 x 2 Zähne/teeth/ зубчики Mit Führungsstift/ with guide pin / с направляющим штифтом				
Glatte Maulteile / smooth Jaws / гладкие губки				
				
	Ø 0,4 mm	Ø 0,4 mm	Ø 0,7 mm	Ø 0,7 mm
18 cm / 7"	05-1140-18T	05-1145-18T	05-1142-18T	05-1147-18T
21 cm / 8 1/4"	05-1140-21T	05-1145-21T	05-1142-21T	05-1147-21T





Micro-Pinzetten –Design-Griff
Micro Forceps - Design handle
Микро Пинцет - Design ручка





Mit Führungsstift, Fadenplatte / with guide pin, tying platform / с направляющим штифтом, платформа для завязывания нитей				
	Glatte Maulteile / smooth Jaws / гладкие губки		Wolfram-Karbid-Beschichtung /Wolfram Carbide Tip Coating/Покрытие карбид вольфрама	
1 x 2 Zähne/teeth/ зубчики				
	0,3 x 6,0 mm	0,3 x 6,0 mm	0,3 x 6,0 mm	0,3 x 6,0 mm
12 cm/4 3/4"	05-9078-12-0.3B	05-9079-12-0.3B	05-9078-12-0.3BD	05-9079-12-0.3BD
15 cm / 6"	05-9078-15-0.3B	05-9079-15-0.3B	05-9078-15-0.3BD	05-9079-15-0.3BD
18 cm / 7"	05-9078-18-0.3B	05-9079-18-0.3B	05-9078-18-0.3BD	05-9079-18-0.3BD
21 cm / 8 1/4"	05-9078-21-0.3B	05-9079-21-0.3B	05-9078-21-0.3BD	05-9079-21-0.3BD
23 cm / 9"	05-9078-23-0.3B	05-9079-23-0.3B	05-9078-23-0.3BD	05-9079-23-0.3BD
	0,7 x 6,0 mm	0,7 x 6,0 mm	0,7 x 6,0 mm	0,7 x 6,0 mm
12 cm/4 3/4"	05-9078-12B	05-9079-12B	05-9078-12BD	05-9079-12BD
15 cm / 6"	05-9078-15B	05-9079-15B	05-9078-15BD	05-9079-15BD
18 cm / 7"	05-9078-18B	05-9079-18B	05-9078-18BD	05-9079-18BD
21 cm / 8 1/4"	05-9078-21B	05-9079-21B	05-9078-21BD	05-9079-21BD
23 cm / 9"	05-9078-23B	05-9079-23B	05-9078-23BD	05-9079-23BD





Mit eingesetztem Maul/ Serrated Jaws/c
заужеными губками
Mit Führungsstift/ with guide pin / с
направляющим штифтом

	Ø 0,3 mm
12 cm/4 3/4"	05-9070-12BDIL
15 cm / 6"	05-9070-15BDIL
18 cm / 7"	05-9070-18BDIL

Micro-Pinzetten – TOLEDO-Griff
Micro Forceps - TOLEDO handle
Мікро Пинцет - ТОЛЕДО ручка

Mikro Ring/ Micro Ring/микро колечко Ø 1,0 x 0,5 mm Mit Führungsstift/ with guide pin / с направляющим штифтом				
	Glatte Maulteile / smooth Jaws / гладкие губки		Wolfram-Karbid-Beschichtung /Wolfram Carbide Tip Coating/Покрытие карбид вольфрама	
				
	1,0 x 0,5 mm	1,0 x 0,5 mm	1,0 x 0,5 mm	1,0 x 0,5 mm
12 cm / 4 3/4"	05-9080-12B	05-9080-12BG	05-9080-12BD	05-9080-12BGD
15 cm / 6"	05-1180-15T	05-1185-15T	05-1660-15T	05-1665-15T
18 cm / 7"	05-1180-18T	05-1185-18T	05-1660-18T	05-1665-18T
21 cm / 8 1/4"	05-1180-21T	05-1185-21T	05-1660-21T	05-1665-21T
23 cm / 9"	05-9080-23B	05-9080-23BG	05-9080-23BD	05-9080-23BGD
	2,0 x 1,0 mm	2,0 x 1,0 mm	2,0 x 1,0 mm	2,0 x 1,0 mm
12 cm / 4 3/4"	05-9082-12B	05-9082-12BG	05-9082-12BD	05-9082-12BGD
15 cm / 6"	05-9082-15B	05-9082-15BG	05-9082-15BD	05-9082-15BGD
18 cm / 7"	05-9082-18B	05-9082-18BG	05-9082-18BD	05-9082-18BGD
21 cm / 8 1/4"	05-9082-21B	05-9082-21BG	05-9082-21BD	05-9082-21BGD
23 cm / 9"	05-9082-23B	05-9082-23BG	05-9082-23BD	05-9082-23BGD

Mikro Ring/ Micro Ring/микро колечко Mit Führungsstift/ with guide pin/ с направляющим штифтом		
	Fein gerieft/ fine serrated/ с тонкой насечкой	
		
	1,0 x 0,5 mm	1,0 x 0,5 mm
12 cm / 4 3/4"	05-9081-12B	05-9081-12BG
15 cm / 6"	05-9081-15B	05-9081-15BG
18 cm / 7"	05-9081-18B	05-9081-18BG
21 cm / 8 1/4"	05-9081-21B	05-9081-21BG
23 cm / 9"	05-9081-23B	05-9081-23BG
	2,0 x 1,0 mm	2,0 x 1,0 mm
12 cm / 4 3/4"	05-9083-12B	05-9083-12BG
15 cm / 6"	05-9083-15B	05-9083-15BG
18 cm / 7"	05-9083-18B	05-9083-18BG
21 cm / 8 1/4"	05-9083-21B	05-9083-21BG
23 cm / 9"	05-9083-23B	05-9083-23BG







Micro-Pinzetten – TOLEDO-Griff
Micro Forceps - TOLEDO handle
Micro Пинцет - ТОЛЕДО ручка





Mikro Ring/ Micro Ring/микро колечко
Mit Führungsstift, Fadenplatte / with guide pin,
tying platform / с направляющим штифтом,
платформа для завязывания нитей

	Wolfram-Karbid-Beschichtung /Wolfram Carbide Tip Coating/Покрытие карбид вольфрама	
		
	1,0 x 0,5 mm	2,0 x 1,0 mm
12 cm/4 3/4"	05-9085-12BD	05-9087-12BD
15 cm / 6"	05-9085-15BD	05-9087-15BD
18 cm / 7"	05-9085-18BD	05-9087-18BD
21 cm / 8 1/4"	05-9085-21BD	05-9087-21BD
23 cm / 9"	05-9085-23BD	05-9087-23BD









Titan Mikro-Pinzette, Ø 8 mm
Titanium Micro Forceps, Ø 8 mm



De BAKEY		
Mit Führungsstift/ with guide pin/ с направляющим штифтом		
		
	1,2 mm	1,2 mm
12 cm 4 3/4"	05-130-12BT	05-131-12BT
15 cm / 6"	05-130-15BT	05-131-15BT
18 cm / 7"	05-130-18BT	05-131-18BT
21 cm / 8 1/4"	05-130-21BT	05-131-21BT
23 cm / 9"	05-130-23BT	05-131-23BT
	1,8 mm	1,8 mm
12 cm 4 3/4"	05-132-12BT	05-133-12BT
15 cm / 6"	05-132-15BT	05-133-15BT
18 cm / 7"	05-132-18BT	05-133-18BT
21 cm / 8 1/4"	05-133-21BT	05-133-21BT
23 cm / 9"	05-133-23BT	05-133-23BT







Mikro-Pinzetten – Rundgriff – Titan
Micro Forceps - Round Handle – Titanium
Микро Пинцет - Круглая ручка Титан





Mit Fadenplatte / with tying platform / с платформой для завязывания нитей Mit Führungsstift/ with guide pin/ с направляющим штифтом				
	Glatte Maulteile / smooth Jaws / гладкие губки		Wolfram-Karbid-Beschichtung /Wolfram Carbide Tip Coating/Покрытие карбид вольфрама	
				
	0,4 x 6,0 mm	0,4 x 6,0 mm	0,4 x 6,0 mm	0,4 x 6,0 mm
15 cm / 6"	05-102-15BT	05-103-15BT	05-102-15BTD	05-103-15BTD
18 cm / 7"	05-102-18BT	05-103-18BT	05-102-18BTD	05-103-18BTD
21 cm / 8 1/4"	05-102-21BT	05-103-21BT	05-102-21BTD	05-103-21BTD
23 cm / 9"	05-102-23BT	05-103-23BT	05-102-23BTD	05-103-23BTD
	0,8 x 6,0 mm	0,8 x 6,0 mm	0,8 x 6,0 mm	0,8 x 6,0 mm
15 cm / 6"	05-100-15BT	05-101-15BT	05-100-15BTD	05-101-15BTD
18 cm / 7"	05-100-18BT	05-101-18BT	05-100-18BTD	05-101-18BTD
21 cm / 8 1/4"	05-100-21BT	05-101-21BT	05-100-21BTD	05-101-21BTD
23 cm / 9"	05-100-23BT	05-101-23BT	05-100-23BTD	05-101-23BTD
1 x 2 Zähne/teeth/ зубчики				
	0,4 x 6,0 mm	0,4 x 6,0 mm	0,4 x 6,0 mm	0,4 x 6,0 mm
15 cm / 6"	05-106-15BT	05-107-15BT	05-106-15BTD	05-107-15BTD
18 cm / 7"	05-106-18BT	05-107-18BT	05-106-18BTD	05-107-18BTD
21 cm / 8 1/4"	05-106-21BT	05-107-21BT	05-106-21BTD	05-107-21BTD
23 cm / 9"	05-106-23BT	05-107-23BT	05-106-23BTD	05-107-23BTD
	0,8 x 6,0 mm	0,8 x 6,0 mm	0,8 x 6,0 mm	0,8 x 6,0 mm
15 cm / 6"	05-104-15BT	05-105-15BT	05-104-15BTD	05-105-15BTD
18 cm / 7"	05-104-18BT	05-105-18BT	05-104-18BTD	05-105-18BTD
21 cm / 8 1/4"	05-104-21BT	05-105-21BT	05-104-21BTD	05-105-21BTD
23 cm / 9"	05-104-23BT	05-105-23BT	05-104-21BTD	05-105-23BTD





Mikro-Pinzetten – Rundgriff – Titan
Micro Forceps - Round Handle – Titanium
Микро Пинцет - Круглая ручка Титан



Glatte Maulteile / smooth Jaws / гладкие губки Mit Führungsstift/ with guide pin/ с направляющим штифтом				
	Glatte Maulteile / smooth Jaws / гладкие губки		Wolfram-Karbid-Beschichtung /Wolfram Carbide Tip Coating/Покрытие карбид вольфрама	
				
	0,4 mm	0,4 mm	0,4 mm	0,4 mm
12 cm 4¾"	05-112-12BT	05-113-12BT	05-112-12BTD	05-113-12BTD
15 cm / 6"	05-112-15BT	05-113-15BT	05-112-15BTD	05-113-15BTD
18 cm / 7"	05-112-18BT	05-113-18BT	05-112-18BTD	05-113-18BTD
21 cm / 8 1/4"	05-112-21BT	05-113-21BT	05-112-21BTD	05-113-21BTD
23 cm / 9"	05-112-23BT	05-113-23BT	05-112-23BTD	05-113-23BTD
	0,8 mm	0,8 mm	0,8 mm	0,8 mm
12 cm 4¾"	05-110-12BT	05-111-12BT	05-110-12BTD	05-111-12BTD
15 cm / 6"	05-110-15BT	05-111-15BT	05-110-15BTD	05-111-15BTD
18 cm / 7"	05-110-18BT	05-111-18BT	05-110-18BTD	05-111-18BTD
21 cm / 8 1/4"	05-110-21BT	05-111-21BT	05-110-21BTD	05-111-21BTD
23 cm / 9"	05-110-23BT	05-111-23BT	05-110-23BTD	05-111-23BTD

Mikro Ring/ Micro Ring/микро колечко Mit Führungsstift/ with guide pin/ с направляющим штифтом				
	Glatte Maulteile / smooth Jaws / гладкие губки		Wolfram-Karbid-Beschichtung /Wolfram Carbide Tip Coating/Покрытие карбид вольфрама	
				
	1,0 x 0,5 mm	1,0 x 0,5 mm	1,0 x 0,5 mm	1,0 x 0,5 mm
15 cm / 6"	05-120-15BT	05-120-15BTG	05-120-15BTD	05-120-15BTDG
18 cm / 7"	05-120-18BT	05-120-18BTG	05-120-18BTD	05-120-18BTDG
21 cm / 8 1/4"	05-120-21BT	05-120-21BTG	05-120-21BTD	05-120-21BTDG
23 cm / 9"	05-120-23BT	05-120-23BTG	05-120-23BTD	05-120-23BTDG
	2,0 x 1,0 mm	2,0 x 1,0 mm	2,0 x 1,0 mm	2,0 x 1,0 mm
15 cm / 6"	05-122-15BT	05-122-15BTG	05-122-15BTD	05-122-15BTDG
18 cm / 7"	05-122-18BT	05-122-18BTG	05-122-18BTD	05-122-18BTDG
21 cm / 8 1/4"	05-122-21BT	05-122-21BTG	05-122-21BTD	05-122-21BTDG
23 cm / 9"	05-122-23BT	05-122-23BTG	05-122-23BTD	05-122-23BTDG



Mikro-Pinzetten – Rundgriff – Titan
Micro Forceps - Round Handle – Titanium
Микро Пинцет - Круглая ручка Титан

Mikro Ring/ Micro Ring/микро колечко
Mit Führungsstift/ with guide pin/ с
направляющим штифтом

	Fein gerieft/ fine serrated/ с тонкой насечкой	
		
	1,0 x 0,5 mm	1,0 x 0,5 mm
12 cm 4¾"	05-121-12BT	05-121-12BTG
15 cm / 6"	05-121-15BT	05-121-15BTG
18 cm / 7"	05-121-18BT	05-121-18BTG
21 cm / 8 1/4"	05-121-21BT	05-121-21BTG
23 cm / 9"	05-121-23BT	05-121-23BTG
	2,0 x 1,0 mm	2,0 x 1,0 mm
12 cm 4¾"	05-123-12BT	05-123-12BTG
15 cm / 6"	05-123-15BT	05-123-15BTG
18 cm / 7"	05-123-18BT	05-123-18BTG
21 cm / 8 1/4"	05-123-21BT	05-123-21BTG
23 cm / 9"	05-123-23BT	05-123-23BTG

Mikro Ring/ Micro Ring/микро колечко
Mit Führungsstift/ with guide pin/ с
направляющим штифтом
Mit Fadenplatte / with tying platform / с
платформой для завязывания нитей

**Wolfram-Karbid-Beschichtung
/Wolfram Carbide Tip
Coating/Покрытие карбид
вольфрама**

		
	1,0 x 0,5 mm	2,0 x 1,0 mm
	12 cm 4¾"	05-125-12BTD
15 cm / 6"	05-125-15BTD	05-127-15BTD
18 cm / 7"	05-125-18BTD	05-127-18BTD
21 cm / 8 1/4"	05-125-21BTD	05-127-21BTD
23 cm / 9"	05-125-23BTD	05-127-23BTD



Micro-Pinzette – TOLEDO-Griff
Micro Forceps - TOLEDO handle
Micro Пинцет - ТОЛЕДО ручка









Mit Fadenplatte / with tying platform / с платформой для завязывания нитей Mit Führungsstift/ with guide pin/ с направляющим штифтом				
	Glatte Maulteile / smooth Jaws / гладкие губки		Wolfram-Karbid-Beschichtung /Wolfram Carbide Tip Coating/Покрытие карбид вольфрама	
	0,3 x 6,0 mm	0,3 x 6,0 mm	0,3 x 6,0 mm	0,3 x 6,0 mm
15 cm / 6"	05-9174-15B	05-9175-15B	05-9174-15BD	05-9175-15BD
18 cm / 7"	05-9174-18B	05-9175-18B	05-9174-18BD	05-9175-18BD
21 cm / 8 1/4"	05-9174-21B	05-9175-21B	05-9174-21BD	05-9175-21BD
23 cm / 9"	05-9174-23B	05-9175-23B	05-9174-23BD	05-9175-23BD
25 cm / 9 3/4"	05-9174-24B	05-9175-25B	05-9174-24BD	05-9175-25BD
1 x 2 Zähne/teeth/ зубчики				
	0,3 x 6,0 mm	0,3 x 6,0 mm	0,3 x 6,0 mm	0,3 x 6,0 mm
15 cm / 6"	05-9178-15.03B	05-9179-15.03B	05-9178-15.03BD	05-9179-15.03BD
18 cm / 7"	05-9178-18.03B	05-9178-18.03B	05-9178-18.03BD	05-9178-18.03BD
21 cm / 8 1/4"	05-9178-21.03B	05-9178-21.03B	05-9178-21.03BD	05-9178-21.03BD
23 cm / 9"	05-9178-23.03B	05-9178-23.03B	05-9178-23.03BD	05-9178-23.03BD
25 cm / 9 3/4"	05-9178-25.03B	05-9178-25.03B	05-9178-25.03BD	05-9178-25.03BD
	0,7 x 6,0 mm	0,7 x 6,0 mm	0,7 x 6,0 mm	0,7 x 6,0 mm
15 cm / 6"	05-9176-15B	05-9177-15B	05-9174-15BD	05-9175-15BD
18 cm / 7"	05-9176-18B	05-9177-18B	05-9174-18BD	05-9175-18BD
21 cm / 8 1/4"	05-9176-21B	05-9177-21B	05-9174-21BD	05-9175-21BD
23 cm / 9"	05-9176-23B	05-9177-23B	05-9174-23BD	05-9175-23BD
25 cm / 9 3/4"	05-9176-24B	05-9177-25B	05-9174-24BD	05-9175-25BD
1 x 2 Zähne/teeth/ зубчики				
	0,7 x 6,0 mm	0,7 x 6,0 mm	0,7 x 6,0 mm	0,7 x 6,0 mm
15 cm / 6"	05-9178-15B	05-9179-15B	05-9178-15BD	05-9179-15BD
18 cm / 7"	05-9178-18B	05-9178-18B	05-9178-18BD	05-9178-18BD
21 cm / 8 1/4"	05-9178-21B	05-9178-21B	05-9178-21BD	05-9178-21BD
23 cm / 9"	05-9178-23B	05-9178-23B	05-9178-23BD	05-9178-23BD
25 cm / 9 3/4"	05-9178-25B	05-9178-25B	05-9178-25BD	05-9178-25BD





Micro-Pinzette – TOLEDO-Griff
Micro Forceps - TOLEDO handle
Микро Пинцет - ТОЛЕДО ручка

Mit Führungsstift/ with guide pin/ с направляющим штифтом						
	Glatte Maulteile / smooth Jaws / гладкие губки			Wolfram-Karbid-Beschichtung / Wolfram Carbide Tip Coating / Покрытие карбид вольфрама		
						
	0,3 mm	0,3 mm	45° 0,3 mm	0,3 mm	0,3 mm	45° 0,3 mm
15 cm / 6"	05-9170-15B	05-9171-15B	05-9175-15BA	05-9170-15BD	05-9171-15BD	05-9175-15BAD
18 cm / 7"	05-9170-18B	05-9171-18B	05-9175-18BA	05-9170-18BD	05-9171-18BD	05-9175-18BAD
21 cm / 8 1/4"	05-9170-21B	05-9171-21B		05-9170-21BD	05-9171-21BD	
23 cm / 9"	05-9170-23B	05-9171-23B		05-9170-23BD	05-9171-23BD	
25 cm / 9 3/4"	05-9170-25B	05-9171-25B		05-9170-25BD	05-9171-25BD	
	0,7 mm	0,7 mm		0,7 mm	0,7 mm	
15 cm / 6"	05-9172-15B	05-9173-15B		05-9172-15BD	05-9173-15BD	
18 cm / 7"	05-9172-18B	05-9173-18B		05-9172-18BD	05-9173-18BD	
21 cm / 8 1/4"	05-9172-21B	05-9173-21B		05-9172-21BD	05-9173-21BD	
23 cm / 9"	05-9172-23B	05-9173-23B		05-9172-23BD	05-9173-23BD	
25 cm / 9 3/4"	05-9172-25B	05-9173-25B		05-9172-25BD	05-9173-25BD	









De BAKEY				
				
	1,2 mm	1,2 mm	2,0 mm	2,0 mm
18 cm / 7"	05-1808-18T	05-1809-18T	05-9186-18B	05-9188-18B
21 cm / 8 1/4"	05-1808-21T	05-1809-21T	05-9186-21B	05-9188-21B





Micro-Pinzette – TOLEDO-Griff
Micro Forceps - TOLEDO handle
Micro Пинцет - ТОЛЕДО ручка

Mit Fadenplatte / with tying platform / с платформой для завязывания нитей
Mit Führungsstift/ with guide pin/ с направляющим штифтом

	Glatte Maulteile / smooth Jaws / гладкие губки		Wolfram-Karbid-Beschichtung /Wolfram Carbide Tip Coating/Покрытие карбид вольфрама	
	0,4 x 7,0 mm	0,4 x 7,0 mm	0,4 x 7,0 mm	0,4 x 7,0 mm
				
18 cm / 7"	05-1882-18T	05-1883-18T	05-1782-18T	05-1783-18T
21 cm / 8 1/4"	05-1882-21T	05-1883-21T	05-1782-21T	05-1783-21T
	0,7 x 7,0 mm	0,7 x 7,0 mm	0,7 x 7,0 mm	0,7 x 7,0 mm
				
18 cm / 7"	05-1887-18T	05-1899-18T	05-1787-18T	05-1799-18T
21 cm / 8 1/4"	05-1887-21T	05-1899-21T	05-1787-21T	05-1799-21T

PIERSE

Mit Führungsstift/ with guide pin / с направляющим штифтом



0,3 mm

15 cm / 6"

05-9170-15BP

18 cm / 7"

05-9170-18BP



Micro-Pinzette – TOLEDO-Griff
Micro Forceps - TOLEDO handle
Микро Пинцет - ТОЛЕДО ручка

Mikro Ring/ Micro Ring/микро колечко Mit Führungsstift/ with guide pin/ с направляющим штифтом						
	Glatte Maulteile / smooth Jaws / гладкие губки		Fein gerieft/ fine serrated/ с тонкой насечкой		Wolfram-Karbid-Beschichtung /Wolfram Carbide Tip Coating/Покрытие карбид вольфрама	
	1,0 x 0,5 mm	1,0 x 0,5 mm	1,0 x 0,5 mm	1,0 x 0,5 mm	1,0 x 0,5 mm	1,0 x 0,5 mm
15 cm / 6"	05-9180-15B	05-9180-15BG	05-9181-15B	05-9181-15BG	05-9180-15BD	05-9180-15BGD
18 cm / 7"	05-1892-18T	05-1893-18T	05-9181-18B	05-9181-18G	05-1792-18T	05-1793-18T
21 cm / 8 1/4"	05-1892-21T	05-1893-21T	05-9181-21B	05-9181-21G	05-1792-21T	05-1793-21T
23 cm / 9"	05-9180-23B	05-9180-23BG	05-9181-23B	05-9181-23G	05-9180-23BD	05-9180-23BGD
25 cm / 9 3/4"	05-9180-25B	05-9180-25BG	05-9181-25B	05-9181-25G	05-9180-25BD	05-9180-25BGD
	2,0 x 1,0 mm	2,0 x 1,0 mm	2,0 x 1,0 mm	2,0 x 1,0 mm	2,0 x 1,0 mm	2,0 x 1,0 mm
15 cm / 6"	05-9182-15B	05-9182-15BG	05-9183-15B	05-9183-15BG	05-9182-15BD	05-9182-15BGD
18 cm / 7"	05-9182-18B	05-9182-18BG	05-9183-18B	05-9183-18BG	05-9182-18BD	05-9182-18BGD
21 cm / 8 1/4"	05-9182-21B	05-9182-21BG	05-9183-21B	05-9183-21BG	05-9182-21BD	05-9182-21BGD
23 cm / 9"	05-9182-23B	05-9182-23BG	05-9183-23B	05-9183-23BG	05-9182-23BD	05-9182-23BGD
25 cm / 9 3/4"	05-9182-25B	05-9182-25BG	05-9183-25B	05-9183-25BG	05-9182-25BD	05-9182-25BGD

Mit eingesetztem Maul/ Serrated
Jaws/с заужеными губками

	Ø 0,3 mm
15 cm / 6"	05-9170-15B-DIL
18 cm / 7"	05-9170-18B-DIL





Mikro-Pinzetten – Rundgriff – Titan
Micro Forceps - Round Handle – Titanium
Микро Пинцет - Круглая ручка Титан

De BAKEY				
Mit Führungsstift 2,0 mm / with guide pin 2,0 mm / с направляющим штифтом 2,0 mm				
ATRAUMA DE BAKEY				
	1,2 mm	1,2 mm	1,8 mm	1,8 mm
15 cm / 6"	05-230-15BT	05-231-15BT	05-232-15BT	05-233-15BT
18 cm / 7"	05-230-18BT	05-231-18BT	05-232-18BT	05-233-18BT
21 cm / 8 1/4"	05-230-21BT	05-231-21BT	05-232-21BT	05-233-21BT

	Glatte Maulteile / smooth Jaws / гладкие губки		Wolfram-Karbid-Beschichtung /Wolfram Carbide Tip Coating/Покрытие карбид вольфрама	
	0,4 mm	0,4 mm	0,4 mm	0,4 mm
15 cm / 6"	05-212-15BT	05-213-15BT	05-212-15BTD	05-213-15BTD
18 cm / 7"	05-212-18BT	05-213-18BT	05-212-18BTD	05-213-18BTD
21 cm / 8 1/4"	05-212-21BT	05-213-21BT	05-212-21BTD	05-213-21BTD
	0,8 mm	0,8 mm	0,8 mm	0,8 mm
15 cm / 6"	05-210-15BT	05-211-15BT	05-210-15BTD	05-211-15BTD
18 cm / 7"	05-210-18BT	05-211-18BT	05-210-18BTD	05-211-18BTD
21 cm / 8 1/4"	05-210-21BT	05-211-21BT	05-210-21BTD	05-211-21BTD



Mikro-Pinzetten – Rundgriff – Titan
Micro Forceps - Round Handle – Titanium
Микро Пинцет - Круглая ручка Титан

Mit Fadenplatte / with tying platform / с платформой для завязывания нитей Mit Führungsstift 2,0 mm / with guide pin 2,0 mm / с направляющим штифтом 2,0 mm				
	Glatte Maulteile / smooth Jaws / гладкие губки		Wolfram-Karbid-Beschichtung / Wolfram Carbide Tip Coating/Покрытие карбид вольфрама	
	0,4 x 6,0 mm	0,4 x 6,0 mm	0,4 x 6,0 mm	0,4 x 6,0 mm
15 cm / 6"	05-202-15BT	05-203-15BT	05-202-15BTD	05-203-15BTD
18 cm / 7"	05-202-18BT	05-203-18BT	05-202-18BTD	05-203-18BTD
21 cm / 8 1/4"	05-202-21BT	05-203-21BT	05-202-21BTD	05-203-21BTD
1 x 2 Zähne/teeth/ зубчики				
15 cm / 6"	05-206-15BT	05-207-15BT	05-206-15BTD	05-207-15BTD
18 cm / 7"	05-206-18BT	05-207-18BT	05-206-18BTD	05-207-18BTD
21 cm / 8 1/4"	05-206-21BT	05-207-21BT	05-206-21BTD	05-207-21BTD
	0,8 x 6,0 mm	0,8 x 6,0 mm	0,8 x 6,0 mm	0,8 x 6,0 mm
15 cm / 6"	05-200-15BT	05-201-15BT	05-200-15BTD	05-201-15BTD
18 cm / 7"	05-200-18BT	05-201-18BT	05-200-18BTD	05-201-18BTD
21 cm / 8 1/4"	05-200-21BT	05-201-21BT	05-200-21BTD	05-201-21BTD
1 x 2 Zähne/teeth/ зубчики				
15 cm / 6"	05-204-15BT	05-205-15BT	05-204-15BTD	05-205-15BTD
18 cm / 7"	05-204-18BT	05-205-18BT	05-204-18BTD	05-205-18BTD
21 cm / 8 1/4"	05-204-21BT	05-205-21BT	05-204-21BTD	05-205-21BTD





Mikro-Pinzetten – Rundgriff – Titan
Micro Forceps - Round Handle – Titanium
Микро Пинцет - Круглая ручка Титан

Mikro Ring/ Micro Ring/микро колечко Mit Führungsstift 2,0 mm / with guide pin 2,0 mm / с направляющим штифтом 2,0 mm						
	Glatte Maulteile / smooth Jaws / гладкие губки		Fein gerieft/ fine serrated/ с тонкой насечкой		Wolfram-Karbid-Beschichtung /Wolfram Carbide Tip Coating/Покрытие карбид вольфрама	
	1,0 x 0,5 mm	1,0 x 0,5 mm	1,0 x 0,5 mm	1,0 x 0,5 mm	1,0 x 0,5 mm	1,0 x 0,5 mm
15 cm / 6"	05-220-15BT	05-220-15BTG	05-221-15BT	05-221-15BTG	05-220-15BTD	05-220-15BTGD
18 cm / 7"	05-220-18BT	05-220-18BTG	05-221-18BT	05-221-18BTG	05-220-18BTD	05-220-18BTGD
21 cm / 8 1/4"	05-220-21BT	05-220-21BTG	05-221-21BT	05-221-21BTG	05-220-21BTD	05-220-21BTGD
	2,0 x 1,0 mm	2,0 x 1,0 mm	2,0 x 1,0 mm	2,0 x 1,0 mm	2,0 x 1,0 mm	2,0 x 1,0 mm
15 cm / 6"	05-222-15BT	05-222-15BTG	05-223-15BT	05-223-15BTG	05-222-15BTD	05-222-15BTGD
18 cm / 7"	05-222-18BT	05-222-18BTG	05-223-18BT	05-223-18BTG	05-222-18BTD	05-222-18BTGD
21 cm / 8 1/4"	05-222-21BT	05-222-21BTG	05-223-21BT	05-223-21BTG	05-222-21BTD	05-222-21BTGD







Mikro Ring/ Micro Ring/микро колечко Mit Fadenplatte 10 mm / with tying platform 10 mm / с платформой для завязывания нитей 10 mm Mit Führungsstift/ with guide pin/ с направляющим штифтом		
	Wolfram-Karbid-Beschichtung /Wolfram Carbide Tip Coating/Покрытие карбид вольфрама	
	1,0 x 0,5 mm	2,0 x 1,0 mm
15 cm / 6"	05-225-15BTD	05-227-15BTD
18 cm / 7"	05-225-18BTD	05-227-18BTD
21 cm / 8 1/4"	05-225-21BTD	05-227-21BTD
23 cm / 9"	05-225-23BTD	05-227-23BTD
25 cm / 9 3/4"	05-225-25BTD	05-227-25BTD



Micro-Pinzetten – TOLEDO-Griff
Micro Forceps - TOLEDO handle
Микро Пинцет - ТОЛЕДО ручка

Mit Fadenplatte / with tying platform / с платформой для завязывания нитей

	Glatte Maulteile / smooth Jaws / гладкие губки		Wolfram-Karbid-Beschichtung / Wolfram Carbide Tip Coating / Покрытие карбид вольфрама	
				
	0,4 x 7,0 mm	0,4 x 7,0 mm	0,4 x 7,0 mm	0,4 x 7,0 mm
18 cm / 7"	05-1880-18T	05-1881-18T	05-1780-18T	05-1781-18T
21 cm / 8 1/4"	05-1880-21T	05-1881-21T	05-1780-21T	05-1781-21T
	0,7 x 7,0 mm	0,7 x 7,0 mm	0,7 x 7,0 mm	0,7 x 7,0 mm
18 cm / 7"	05-1860-18T	05-1861-18T	05-1760-18T	05-1761-18T
21 cm / 8 1/4"	05-1860-21T	05-1861-21T	05-1760-21T	05-1761-21T



1 x 2 Zähne/teeth/ зубчики

				
	Ø 0,4 mm	Ø 0,4 mm	Ø 0,7 mm	Ø 0,7 mm
18 cm / 7"	05-1810-18T	05-1811-18T	05-1812-18T	05-1813-18T
21 cm / 8 1/4"	05-1810-21T	05-1811-21T	05-1812-21T	05-1813-21T

De BAKEY

ATRAUMA	
DE BAKEY	
	
1,2 mm	1,2 mm
18 cm / 7"	05-1800-18T 05-1803-18T
21 cm / 8 1/4"	05-1800-21T 05-1803-21T

Mikro Ring/ Micro Ring/микро колечко
Ø 1,0 x 0,5 mm

	Glatte Maulteile / smooth Jaws / гладкие губки	Wolfram-Karbid-Beschichtung / Wolfram Carbide Tip Coating / Покрытие карбид вольфрама
		
	Ø 1,0 x 0,5 mm	Ø 1,0 x 0,5 mm
18 cm / 7"	05-1890-18T	05-1790-18T
21 cm / 8 1/4"	05-1890-21T	05-1790-21T



Micro-Augen-Pinzetten
Micro Eye Forceps
Микро пинцет глазной



Kolibripinzette/ Colibri Forceps/ Колибри пинцет		
	Standardausführung/ Standard/ стандарт	extra fein/ extra fine/ очень тонкий
8 cm / 3 1/4"	05-1221-08	05-1223-08



Augenpinzette/ Utility Forceps/ пинцет глазной		
	Anatomisch/ anatomical/ анатомический	
10 cm / 4"	0,5 mm	05-1450-10
	0,7 mm	05-1452-10
	1,0 mm	05-1454-10
	1,2 mm	05-1456-10
	1,4 mm	05-1458-10
	Chirurgisch /surgical/хирургический	
10 cm / 4"	0,5 mm	05-1460-10
	0,7 mm	05-1462-10
	1,0 mm	05-1464-10
	1,2 mm	05-1466-10
	1,4 mm	05-1468-10



Fadenpinzette
Suture Forceps
Шовный пинцет

TÜBINGEN			
			extra fein/ extra delicate/ экстра тонкий
8,5 cm / 3 1/3"	–	–	05-1410-09
23 cm / 9"	05-1400-11	05-1405-11	–



Micro-Augen-Pinzetten
Micro Eye Forceps
Микро пинцет глазной

BONN	
7,5 cm / 3"	05-1420-08



BONN			
1 x 2			
	Gerade/ straight/прямой	Abgewinkelt/ angled/ угловой	Abgewinkelt/ angled/ угловой
	6,0 mm	6,0 mm	8,0 mm
8 cm / 3 1/4"	05-1320-08	05-1325-08	05-1327-08
	Anatomisch/ anatomical/ анатомический		
	gerade/ straight/прямой	abgewinkelt/ angled/ угловой	abgewinkelt/ angled/ угловой
	6,0 mm	6,0 mm	8,0 mm
8 cm / 3 1/4"	05-1330-08	05-1335-08	05-1337-08





Fadenpinzette
Suture Forceps
Шовный пинцет



BARSEWISCH	
Vorderkammer-Pinzette abgewinkelt /Anterior Chamber Forceps angled/ Пинцет для передней камеры угловой	
8 cm / 3 1/4"	05-1345-08



Haltepinzette
Holding Forceps
Пинцет для держания

FAULKNER			
	5 mm	6 mm	11 mm
10 cm / 4"	05-1310-05	05-1310-06	05-1310-11



Linsenimplantations-Pinzette
Lenze Implantation Forceps Crossaction
Пинцет для имплантации линз

McDONALS-SPALECK		
	5 mm	6 mm
10 cm / 4"	05-1200-10	05-1202-10



Linsenimplantations-Pinzette
Lenze Implantation Forceps Crossaction
Пинцет для имплантации линз



SPALECK				
	Silikon Valv. Rauh/ silicone valv. Rough/ Силикон		Acryl Valv. Hochglanz/ acrylic valv. Glazed/акрил	
	5,6 mm	6,6 mm	5,6 mm	6,6 mm
10 cm / 4"	05-1120-56	05-1120-66	05-1140-56	05-1140-66

