



Leicht  
Medizintechnik



COMMITTED TO QUALITY

CHIRURGIE  
SURGERY  
CHIRURGIE  
CIRUGIA  
ХИРУРГИЯ

Germany

Tuttlingen

**Skalpellklingen, Skalpellgriffe, Messer  
Scalpel Blades, Scalpel Handles, Knives  
Lames de bistouris, Manches de bistouris, Couteaux  
Hojas de bisturíes, Mangos de bisturíes, Cuchillos  
Лезвия для скальпеля, ручки скальпеля  
к съёмным лезвиям, ножи**









No. 3  
13,0 cm, 5"  
01-10-003-00



No. 3  
13,0 cm, 5"  
01-10-003-01



No. 3L  
21,0 cm, 8<sup>1</sup>/<sub>4</sub>"  
01-10-003-02



No. 7  
16,5 cm, 6<sup>1</sup>/<sub>2</sub>"  
01-10-007-00



No. 7K  
13,0 cm, 5"  
01-10-007-01



No. 7L  
22,0 cm, 8<sup>3</sup>/<sub>4</sub>"  
01-10-007-02



No. 3  
21,0 cm, 8<sup>1</sup>/<sub>4</sub>"  
01-10-006-00

Skalpelli  
 Scalpel Handles  
 Manches de bistouris  
 Mangos de bisturias  
 Ручки скальпеля



rund  
 round  
 rond  
 redondo  
 rotondo

rund, abgewinkelt  
 round, angled  
 rond, coudé  
 redondo, angulado  
 rotondo, angolare

No. 4  
 13,5 cm, 5<sup>3</sup>/<sub>8</sub>"  
 01-10-004-00

No. 4L  
 21,0 cm, 8<sup>3</sup>/<sub>8</sub>"  
 01-10-004-01

No. 8  
 13,5 cm, 5<sup>3</sup>/<sub>8</sub>"  
 01-10-008-00

No. 9  
 14,5 cm, 5<sup>3</sup>/<sub>4</sub>"  
 01-10-009-00

No. 3  
 14,5 cm, 5<sup>3</sup>/<sub>4</sub>"  
 01-10-010-14

No. 3  
 14,0 cm, 5<sup>1</sup>/<sub>2</sub>"  
 01-10-010-15

Einmal-Skalpelle, steril  
 Disposable Scalpels, sterile  
 Bistouris usage unique, stériles  
 Bisturios para uso único, estériles  
 Одноразовые скальпели



Fig. 10  
01-10-050-10



Fig. 11  
01-10-050-11



Fig. 12  
01-10-050-12



Fig. 12d  
01-10-050-12D

In Packungen zu 10 Stück, einzeln steril verpackt  
 In packages of 10 ea., individually packed sterile  
 Stérile enveloppe individuelle boîte de 10 bistouris  
 En boites de 10 pieces, en sachets individuels, steriles  
 В пачке 10 шт., каждый запакован отдельно, стерильные



Fig. 13  
01-10-050-13



Fig. 15  
01-10-050-15



Fig. 15c  
01-10-050-15C

Einmal-Skalpelle, steril  
Disposable Scalpels, sterile  
Bistouris usage unique, stériles  
Bisturios para uso único, estériles  
Одноразовые скальпели



Fig. 18  
01-10-050-18



Fig. 19  
01-10-050-19



Fig. 20  
01-10-050-20



Fig. 21  
01-10-050-21

In Packungen zu 10 Stück, einzeln steril verpackt  
In packages of 10 ea., individually packed sterile  
Stérile enveloppe individuelle boîte de 10 bistouris  
En boites de 10 pieces, en sachets individuels, stériles  
В пачке 10 шт., каждый запечатан отдельно, стерильные



Fig. 22  
01-10-050-22



Fig. 23  
01-10-050-23



Fig. 24  
01-10-050-24



Fig. 25  
01-10-050-25



Skalpelleklingen, steril, auswechselbar  
 Scalpel Blades, Sterile, Interchangeable  
 Lames de bistouris, stériles, interchangeables  
 Hojas de bisturíes, esteriles, intercambiables  
 Лезвия для скальпеля, сменные



Fig. 10  
01-10-020-10



Fig. 11  
01-10-020-11



Fig. 12  
01-10-020-12



Fig. 12d  
01-10-020-12d



Fig. 13  
01-10-020-13



Fig. 14  
01-10-020-14



Fig. 15  
01-10-020-15



Fig. 15c  
01-10-020-15c



Fig. 16  
01-10-020-16



Fig. 17  
01-10-020-17



Fig. 18  
01-10-020-18



Fig. 19  
01-10-020-19



Fig. 20  
01-10-020-20



Fig. 21  
01-10-020-21



Fig. 22  
01-10-020-22



Fig. 23  
01-10-020-23

In Packungen zu 100 Stück, einzeln steril verpackt  
 In packages of 100 ea., individually packed sterile  
 Enveloppe individuelle boîte de 100 lames  
 En boîtes de 100 pièces, en sachets individuels, stériles  
 В пачке 100 шт., каждый запечатан отдельно, стерильные



Fig. 24  
01-10-020-24



Fig. 25  
01-10-020-25



Fig. 36  
01-10-020-36



Kling-Ex  
Skalpelleklingenabnehmer  
01-10-020-40



Skalpelklingenabnehmer  
14 cm  
01-10-021-14

Skalpelle  
Knives  
Bistouris  
Bisturies  
Ножи



**OPERATION**  
17,0 cm, 6¾"

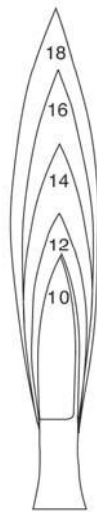

Fig. 10 01-10-060-10  
Fig. 12 01-10-060-12  
Fig. 14 01-10-060-14  
Fig. 16 01-10-060-16  
Fig. 18 01-10-060-18



**COLLIN**  
16,0 cm, 6¼"



Fig. 1 01-10-066-01  
Fig. 2 01-10-066-02  
Fig. 3 01-10-066-03



Fig. 4 01-10-066-04  
Fig. 5 01-10-066-05  
Fig. 6 01-10-066-06



Fig. 1 01-10-070-01  
Fig. 2 01-10-070-02  
Fig. 3 01-10-070-03  
Fig. 4 01-10-070-04  
Fig. 5 01-10-070-05



Fig. 1 01-10-076-01  
Fig. 2 01-10-076-02  
Fig. 3 01-10-076-03  
Fig. 4 01-10-076-04  
Fig. 5 01-10-076-05



Fig. 15  
01-10-078-15

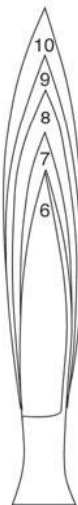

Fig. 6 01-10-070-06  
Fig. 7 01-10-070-07  
Fig. 8 01-10-070-08  
Fig. 9 01-10-070-09  
Fig. 10 01-10-070-10

**DISSECTING**  
17,0 cm, 3/4"



Fig. 6 01-10-076-06  
Fig. 7 01-10-076-07  
Fig. 8 01-10-076-08  
Fig. 9 01-10-076-09

**DIEFENBACH**  
16,0 cm, 6 1/4"



Fig. 16  
01-10-078-16

Amputationsmesser  
 Amputation Knives  
 Amputation de couteaux  
 Cuchillos para amputación  
 Ножы ампутационные

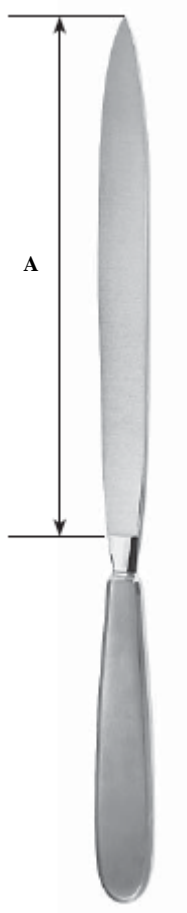

**COLLIN**

<b>A</b>	13,0 cm, 5"	<b>01-10-080-13</b>
	16,0 cm, 6 $\frac{1}{4}$ "	<b>01-10-080-16</b>
	19,0 cm, 7 $\frac{1}{2}$ "	<b>01-10-080-19</b>
	22,0 cm, 8 $\frac{5}{8}$ "	<b>01-10-080-22</b>
	28,0 cm, 11"	<b>01-10-080-28</b>

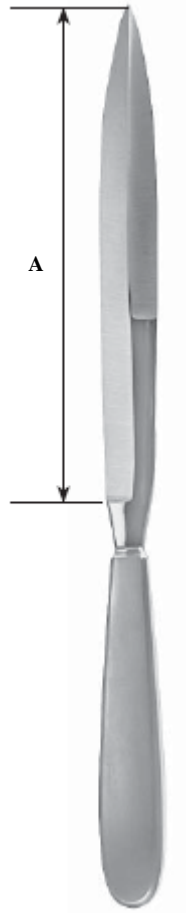

**CATLIN**

<b>A</b>	16,0 cm, 6 $\frac{1}{4}$ "	<b>01-10-082-16</b>
	19,0 cm, 7 $\frac{1}{2}$ "	<b>01-10-082-19</b>
	22,0 cm, 8 $\frac{5}{8}$ "	<b>01-10-082-22</b>

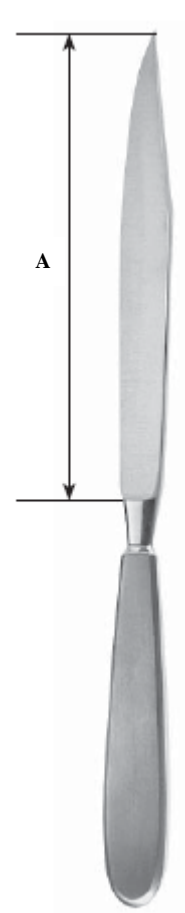

**LISTON**

<b>A</b>	17,0 cm, 6 $\frac{3}{4}$ "	<b>01-10-250-17</b>
	20,0 cm, 8"	<b>01-10-250-20</b>



Amputationsmesser, Messer für Autopsie  
Amputation Knives, Post Mortem Knives  
Amputation de couteaux, Couteau pour autopsie  
Cuchillos para amputación, Cuchillos para autopsia  
Ножи ампутационные, ножи для органов



**LANGENBECK**  
A

16,0 cm, 6½" 01-10-280-16

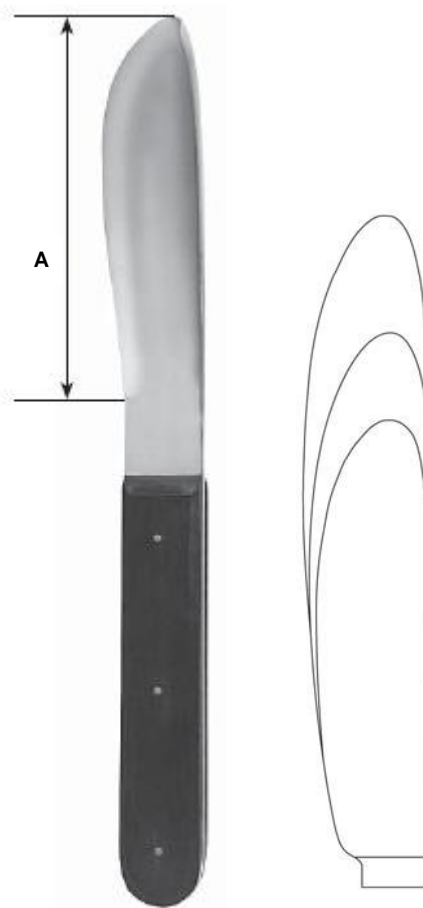

**WALB**  
A

11,0 cm, 4½" 01-10-150-11  
14,0 cm, 5½" 01-10-150-14  
17,0 cm, 6¾" 01-10-150-17

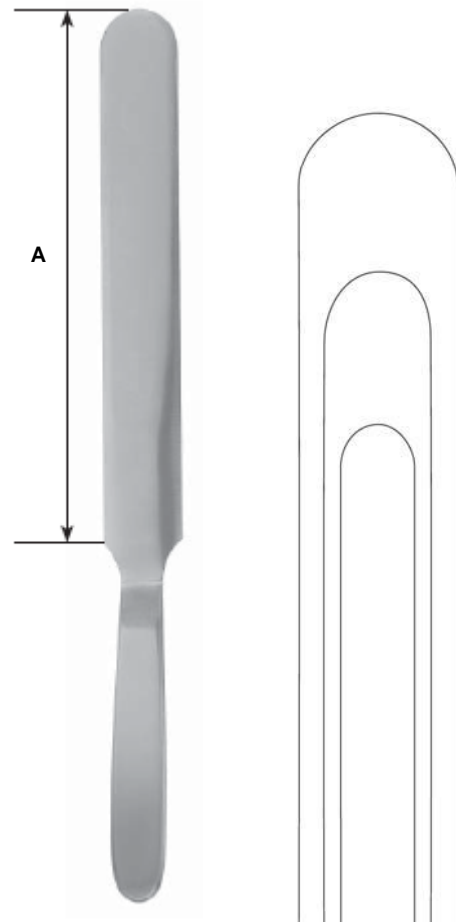

**VIRCHOW**  
A

16,0 cm, 6¼" 01-10-180-16  
20,0 cm, 8" 01-10-180-20  
24,0 cm, 9½" 01-10-180-24



Resektionsmesser  
Resection Knives  
Couteaux a resection  
Cuchillos para resección  
Ножи для резекции



**LANGENBECK**  
18,0 cm, 7"  
01-10-105-55



**CARTILAGE**  
17,5 cm, 6 $\frac{5}{8}$ "  
01-10-110-65

mit Schaber  
with raspatory  
manche solide a rugine  
con periostótomo  
с распатором

Haut-Spannplatten  
Skin straightening plate  
Plaque pour tendre la peau  
Placa para extender la piel  
Пластина для натяжения



**01-10-422-30**



**01-10-401-19**  
Ersatzklinge  
Spare blade  
Lame de rechange seule  
Hoja de repuesto  
Запасное лезвие



**SILVER**  
19 cm, 7½"  
01-10-400-19

**01-10-411-30**  
Ersatzklinge  
Spare blade  
Lame de rechange seule  
Hoja de repuesto  
Запасное лезвие



**BRAITHWAITE**  
30 cm, 12"  
01-10-410-30

**01-10-413-35**  
Ersatzklinge  
Spare blade  
Lame de rechange seule  
Hoja de repuesto  
Запасное лезвие



**HUMBY**  
35 cm, 14"  
01-10-412-35

**01-10-421-30**  
Ersatzklinge  
Spare blade  
Lame de rechange seule  
Hoja de repuesto  
Запасное лезвие



**SCHINK**  
30 cm, 12"  
01-10-420-30

Skalpelle, Fistelmesser  
 Knives, Fistula Knives  
 Bisturías para abscesos y fistulas  
 Bistouris a absces et fistules  
 Ножи, Ножи фистульные



**SIMON**  
 23,5 cm, 9 1/2"



Fig. 1  
 01-10-01-10-01

1/1



Fig. 2  
 01-10-01-10-02



Fig. 3  
 01-10-01-10-03

1/1



Fig. 4  
 01-10-01-10-04



Fig. 3



**BARRON**  
 13,0 cm, 5 1/2"  
 01-10-014-14



**DIEFFENBACH**  
 13,0 cm, 5"  
 01-10-100-13



**DIEFFENBACH**  
 13,0 cm, 5"  
 01-10-101-13



Skalpelleklingen, auswechselbar  
Scalpel Blades, interchangeable  
Lames de bistouris, interchangeables  
Hojas de bisturíes, intercambiables  
Лезвия для скальпеля, сменные



Fig. 61  
01-10-040-61



Fig. 62  
01-10-040-62



Fig. 62S  
01-10-040-62S



Fig. 64  
01-10-040-64



Fig. 65  
01-10-040-65



Fig. 67  
01-10-040-67



Fig. 69  
01-10-040-69



10,0 cm  
01-10-030-10



13,00 cm  
01-10-030-13



15,00 cm  
01-10-030-15



Leicht  
Medizintechnik

**Scheren**  
**Scissors**  
**Ciseaux**  
**Tijeras**  
**Ножницы**









10,5 cm, 4¼"	03-11-000-10
11,5 cm, 4½"	03-11-000-11
13,0 cm, 5"	03-11-000-13
14,5 cm, 5¾"	03-11-000-14
15,5 cm, 6"	03-11-000-15
16,5 cm, 6½"	03-11-000-16
17,5 cm, 7"	03-11-000-17
18,5 cm, 7¼"	03-11-000-18
20,0 cm, 8"	03-11-000-20

STANDARD



10,5 cm, 4¼"	03-11-001-10
11,5 cm, 4½"	03-11-001-11
13,0 cm, 5"	03-11-001-13
14,5 cm, 5¾"	03-11-001-14
15,5 cm, 6"	03-11-001-15
16,5 cm, 6½"	03-11-001-16
17,5 cm, 7"	03-11-001-17
18,5 cm, 7¼"	03-11-001-18
20,0 cm, 8"	03-11-001-20

STANDARD

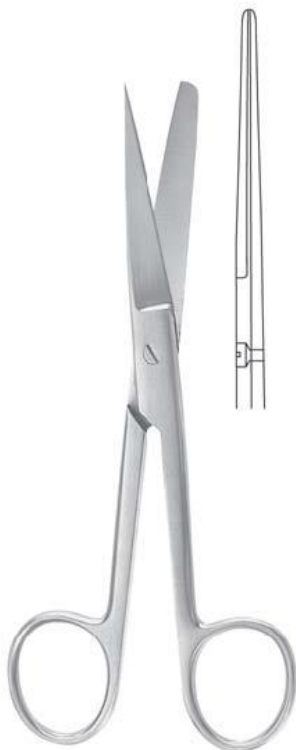

10,5 cm, 4¼"	03-11-002-10
11,5 cm, 4½"	03-11-002-11
13,0 cm, 5"	03-11-002-13
14,5 cm, 5¾"	03-11-002-14
15,5 cm, 6"	03-11-002-15
16,5 cm, 6½"	03-11-002-16
18,5 cm, 7¼"	03-11-002-18
20,0 cm, 8"	03-11-002-20

STANDARD



10,5 cm, 4¼"	03-11-003-10
11,5 cm, 4½"	03-11-003-11
13,0 cm, 5"	03-11-003-13
14,5 cm, 5¾"	03-11-003-14
15,5 cm, 6"	03-11-003-15
16,5 cm, 6½"	03-11-003-16
18,5 cm, 7¼"	03-11-003-18
20,0 cm, 8"	03-11-003-20

STANDARD

Chirurgische Scheren, Präparierscheren  
 Surgical Scissors, Dissecting Scissors  
 Ciseaux chirurgicaux, Ciseaux à dissection  
 Tijeras para cirugía, Tijeras de disección  
 Ножницы хирургические, рассекающие ножницы



STANDARD

- 10,5 cm, 4¼" 03-11-004-10
- 11,5 cm, 4½" 03-11-004-11
- 13,0 cm, 5" 03-11-004-13
- 14,5 cm, 5¾" 03-11-004-14
- 15,5 cm, 6" 03-11-004-15
- 16,5 cm, 6½" 03-11-004-16
- 18,5 cm, 7¼" 03-11-004-18
- 20,0 cm, 8" 03-11-004-20



STANDARD

- 10,5 cm, 4¼" 03-11-005-10
- 11,5 cm, 4½" 03-11-005-11
- 13,0 cm, 5" 03-11-005-13
- 14,5 cm, 5¾" 03-11-005-14
- 15,5 cm, 6" 03-11-005-15
- 16,5 cm, 6½" 03-11-005-16
- 17,5 cm, 7" 03-11-005-17
- 18,5 cm, 7¼" 03-11-005-18
- 20,0 cm, 8" 03-11-005-20



DEAVER

- 12,0 cm, 4¾" 03-11-050-12
- 13,0 cm, 5" 03-11-050-13
- 14,5 cm, 5¾" 03-11-050-14



DEAVER

- 12,0 cm, 4¾" 03-11-051-12
- 13,0 cm, 5" 03-11-051-13
- 14,5 cm, 5¾" 03-11-051-14



Präparierscheren  
Dissecting Scissors  
Ciseaux à dissection  
Tijeras de disección  
Ножницы анатомические



12,0 cm, 4¾" 03-11-052-12  
13,0 cm, 5" 03-11-052-13  
14,5 cm, 5¾" 03-11-052-14

DEAVER



12,0 cm, 4¾" 03-11-053-12  
13,0 cm, 5" 03-11-053-13  
14,5 cm, 5¾" 03-11-053-14

DEAVER



12,0 cm, 4¾" 03-11-054-12  
13,0 cm, 5" 03-11-054-13  
14,5 cm, 5¾" 03-11-054-14

DEAVER

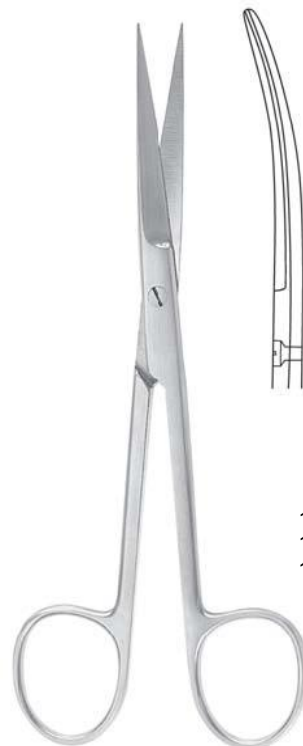

12,0 cm, 4¾" 03-11-055-12  
13,0 cm, 5" 03-11-055-13  
14,5 cm, 5¾" 03-11-055-14

DEAVER

**Präparierscheren**  
**Dissecting Scissors**  
**Ciseaux à dissection**  
**Tijeras de disección**  
**Ножницы анатомические**



13,0 cm, 5" **03-11-070-13**  
 14,5 cm, 5¾" **03-11-070-14**

**GRAZIL**



13,0 cm, 5" **03-11-071-13**  
 14,5 cm, 5¾" **03-11-071-14**

**GRAZIL**



13,0 cm, 5" **03-11-072-13**  
 14,5 cm, 5¾" **03-11-072-14**

**GRAZIL**



13,0 cm, 5" **03-11-073-13**  
 14,5 cm, 5¾" **03-11-073-14**

**GRAZIL**





13,0 cm, 5" 03-11-074-13  
14,5 cm, 5¾" 03-11-074-14

GRAZIL



13,0 cm, 5" 03-11-075-13  
14,5 cm, 5¾" 03-11-075-14

GRAZIL

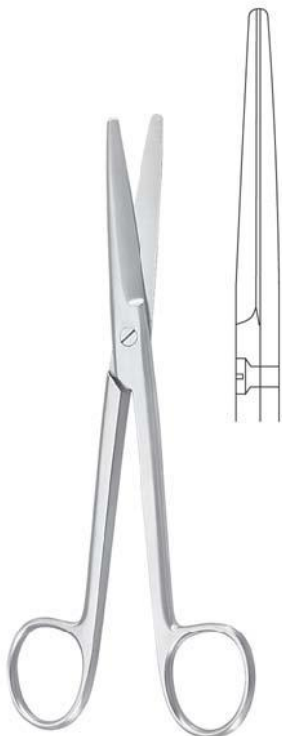

14,5 cm, 5¾" 03-11-100-14  
15,5 cm, 6" 03-11-100-15  
17,0 cm, 6¾" 03-11-100-17  
19,0 cm, 7½" 03-11-100-19  
23,0 cm, 9" 03-11-100-23  
28,0 cm, 11" 03-11-100-28

MAYO

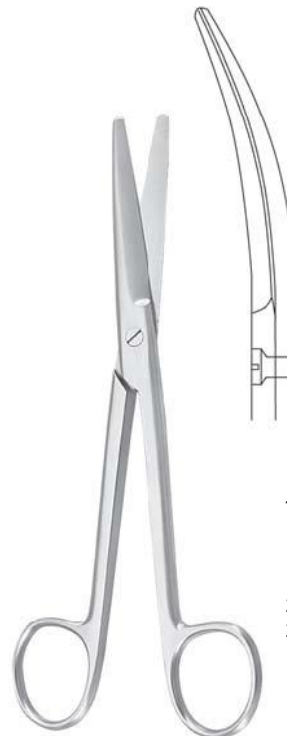

14,5 cm, 5¾" 03-11-101-14  
15,5 cm, 6" 03-11-101-15  
17,0 cm, 6¾" 03-11-101-17  
19,0 cm, 7½" 03-11-101-19  
23,0 cm, 9" 03-11-101-23  
28,0 cm, 11" 03-11-101-28

MAYO

**Präparierscheren**  
**Dissecting Scissors**  
**Ciseaux à dissection**  
**Tijeras de disección**  
**Ножницы анатомические**



15,0 cm, 6" **03-11-102-15**  
 17,0 cm, 6¾" **03-11-102-17**  
 19,5 cm, 7¾" **03-11-102-19**  
 21,0 cm, 8¼" **03-11-102-21**

**MAYO-STILE**



15,0 cm, 6" **03-11-103-15**  
 17,0 cm, 6¾" **03-11-103-17**  
 19,5 cm, 7¾" **03-11-103-19**  
 21,0 cm, 8¼" **03-11-103-21**

**MAYO-STILE**



**03-11-104-17**

**MAYO-NOBLE**  
 17,0 cm, 6¾"



**03-11-105-17**



**FOMON**  
 13,5 cm, 5⅜"  
**03-11-009-13**



Präparierscheren  
Dissecting Scissors  
Ciseaux à dissection  
Tijeras de disección  
Ножницы анатомические



**BABY-METZENBAUM**  
11,5 cm, 4½"



03-11-110-11



03-11-111-11



**METZENBAUM-NELSON**



18,0 cm, 7"	03-11-116-18	03-11-117-18
20,0 cm, 8"	03-11-116-20	03-11-117-20
23,0 cm, 9"	03-11-116-23	03-11-117-23
26,0 cm, 10½"	03-11-116-26	03-11-117-26
28,0 cm, 11"	03-11-116-28	03-11-117-28
30,0 cm, 12"	03-11-116-30	03-11-117-30
36,0 cm, 15"	03-11-116-36	03-11-117-36



**METZENBAUM**

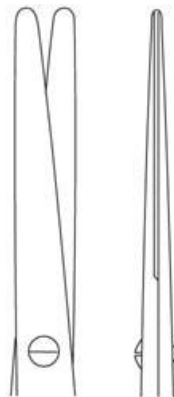

12,5 cm 4¾"	03-11-110-12
14,5 cm, 5¾"	03-11-110-14
18,0 cm, 7"	03-11-110-18
20,0 cm, 8"	03-11-110-20
23,0 cm, 9"	03-11-110-23
25,0 cm, 10"	03-11-110-25
28,0 cm, 11"	03-11-110-28
30,0 cm, 12"	03-11-110-30



**METZENBAUM**

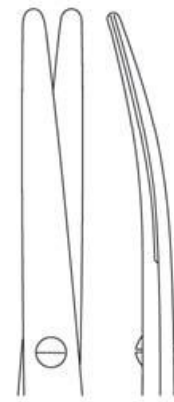

12,5 cm 4¾"	03-11-111-12
14,5 cm, 5¾"	03-11-111-14
18,0 cm, 7"	03-11-111-18
20,0 cm, 8"	03-11-111-20
23,0 cm, 9"	03-11-111-23
25,0 cm, 10"	03-11-111-25
28,0 cm, 11"	03-11-111-28
30,0 cm, 12"	03-11-111-30

**Präparierscheren**  
**Dissecting Scissors**  
**Ciseaux à dissection**  
**Tijeras de disección**  
**Ножницы анатомические**



14,5 cm, 5<sup>3</sup>/<sub>4</sub>" **03-11-112-14**  
 18,0 cm, 7" **03-11-112-18**  
 20,0 cm, 8" **03-11-112-20**  
 23,0 cm, 9" **03-11-112-23**  
 25,0 cm, 10" **03-11-112-25**  
 30,0 cm, 12" **03-11-112-30**

**METZENBAUM**



14,5 cm, 5<sup>3</sup>/<sub>4</sub>" **03-11-113-14**  
 18,0 cm, 7" **03-11-113-18**  
 20,0 cm, 8" **03-11-113-20**  
 23,0 cm, 9" **03-11-113-23**  
 25,0 cm, 10" **03-11-113-25**  
 28,0 cm, 11" **03-11-113-28**  
 30,0 cm, 12" **03-11-113-30**

**METZENBAUM**

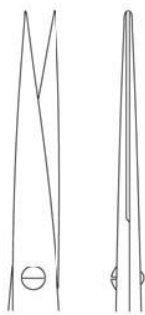

12,5 cm, 4<sup>3</sup>/<sub>4</sub>" **03-11-114-12**  
 14,5 cm, 5<sup>3</sup>/<sub>4</sub>" **03-11-114-14**  
 18,0 cm, 7" **03-11-114-18**  
 20,0 cm, 8" **03-11-114-20**  
 23,0 cm, 9" **03-11-114-23**  
 25,0 cm, 10" **03-11-114-25**  
 28,0 cm, 11" **03-11-114-28**  
 30,0 cm, 12" **03-11-114-30**

**METZENBAUM**



12,5 cm, 4<sup>3</sup>/<sub>4</sub>" **03-11-115-12**  
 14,5 cm, 5<sup>3</sup>/<sub>4</sub>" **03-11-115-14**  
 18,0 cm, 7" **03-11-115-18**  
 20,0 cm, 8" **03-11-115-20**  
 23,0 cm, 9" **03-11-115-23**  
 25,0 cm, 10" **03-11-115-25**  
 28,0 cm, 11" **03-11-115-28**  
 30,0 cm, 12" **03-11-115-30**

**METZENBAUM**



Präparierscheren  
Dissecting Scissors  
Ciseaux à dissection  
Tijeras de disección  
Ножницы анатомические



- 14,5 cm, 5 $\frac{3}{4}$ " 03-11-121-14
- 15,5 cm, 6 $\frac{3}{4}$ " 03-11-121-15
- 18,0 cm, 7" 03-11-121-18
- 20,0 cm, 8" 03-11-121-20
- 23,0 cm, 9" 03-11-121-23
- 25,0 cm, 10" 03-11-121-25
- 28,0 cm, 11" 03-11-121-28
- 30,0 cm, 12" 03-11-121-30

METZENBAUM-FINO



- 14,5 cm, 5 $\frac{3}{4}$ " 03-11-120-14
- 15,5 cm, 6 $\frac{3}{4}$ " 03-11-120-15
- 18,0 cm, 7" 03-11-120-18
- 20,0 cm, 8" 03-11-120-20
- 23,0 cm, 9" 03-11-120-23
- 25,0 cm, 10" 03-11-120-25
- 28,0 cm, 11" 03-11-120-28
- 30,0 cm, 12" 03-11-120-30

METZENBAUM-FINO



- 14,5 cm, 5 $\frac{3}{4}$ " 03-11-124-14
- 18,0 cm, 7" 03-11-124-18
- 20,0 cm, 8" 03-11-124-20
- 23,0 cm, 9" 03-11-124-23

METZENBAUM-FINO



- 14,5 cm, 5 $\frac{3}{4}$ " 03-11-125-14
- 18,0 cm, 7" 03-11-125-18
- 20,0 cm, 8" 03-11-125-20
- 23,0 cm, 9" 03-11-125-23

METZENBAUM-FINO

**Präparierscheren**  
**Dissecting Scissors**  
**Ciseaux à dissection**  
**Tijeras de disección**  
**Ножницы анатомические**

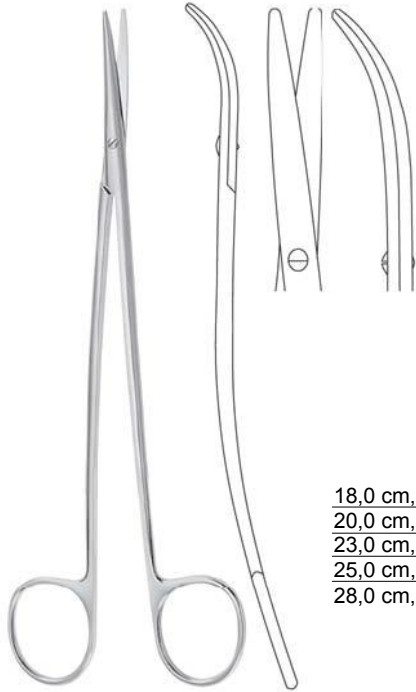

18,0 cm, 7" **03-11-127-18**  
 20,0 cm, 8" **03-11-127-20**  
 23,0 cm, 9" **03-11-127-23**  
 25,0 cm, 10" **03-11-127-25**  
 28,0 cm, 11" **03-11-127-28**

**METZENBAUM-FINO S**

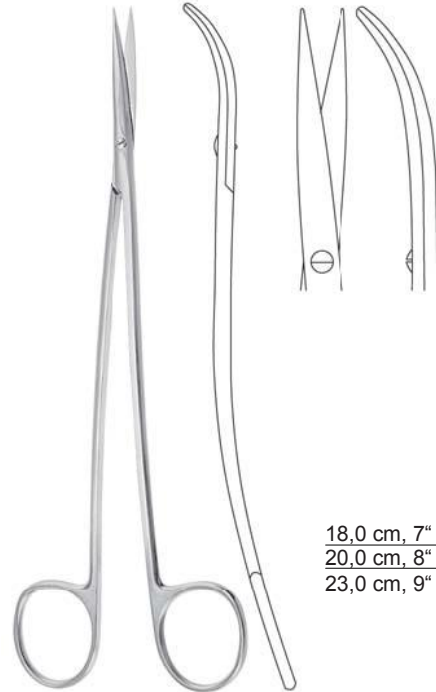

18,0 cm, 7" **03-11-129-18**  
 20,0 cm, 8" **03-11-129-20**  
 23,0 cm, 9" **03-11-129-23**

**METZENBAUM-FINO S**



**METZENBAUM-LAHEY**  
 14,0 cm, 5½"  
**03-11-137-14**

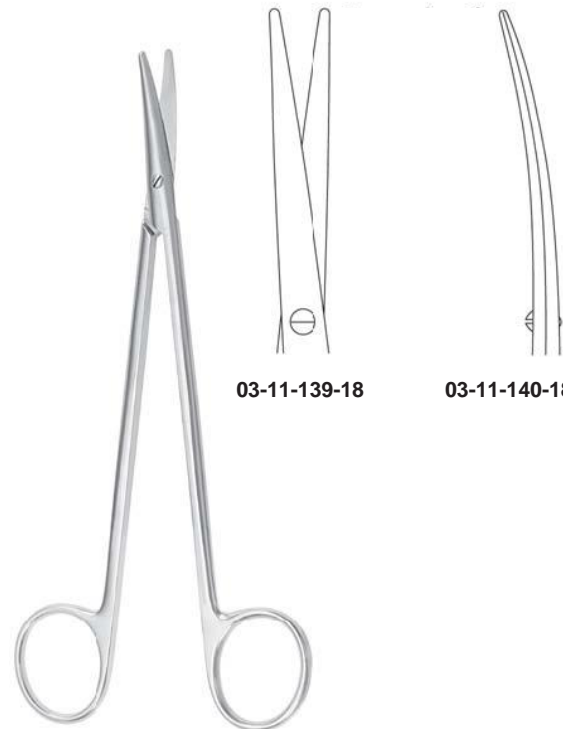

**03-11-139-18**

**03-11-140-18**

**TOENNIS-ADSON**  
 18,0 cm, 7"



Präparierscheren  
Dissecting Scissors  
Ciseaux à dissection  
Tijeras de disección  
Ножницы анатомические



**Präparierscheren, feine chirurgische Scheren**  
**Dissecting Scissors, fine surgical scissors**  
**Ciseaux à dissection, Fins ciseaux chirurgicaux**  
**Tijeras de disección, tijeras finas para cirugía**  
**Ножницы анатомические, тонкие хирургические ножницы**



mit flacher Spitze  
 smath with flat  
 point lisses  
 pointe plat  
 с плоскими концами

12,0 cm, 4<sup>3</sup>/<sub>4</sub>" **03-11-200-12**  
 15,0 cm, 6" **03-11-200-15**  
 18,0 cm, 7" **03-11-200-18**  
 20,0 cm, 8" **03-11-200-20**

**KILNER (RAGNELL)**



mit flacher Spitze  
 smath with flat  
 point lisses  
 pointe plat  
 с плоскими концами

12,0 cm, 4<sup>3</sup>/<sub>4</sub>" **03-11-201-12**  
 15,0 cm, 6" **03-11-201-15**  
 18,0 cm, 7" **03-11-201-18**  
 20,0 cm, 8" **03-11-201-20**

**KILNER (RAGNELL)**

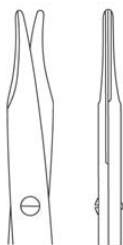

14,0 cm 5<sup>1</sup>/<sub>4</sub>" **03-11-210-14.0**  
 14,5 cm, 5<sup>3</sup>/<sub>4</sub>" **03-11-210-14**  
 15,5 cm, 5<sup>3</sup>/<sub>8</sub>" **03-11-210-15**  
 16,0 cm, 6<sup>1</sup>/<sub>4</sub>" **03-11-210-16**  
 18,0 cm, 7" **03-11-210-18**  
 20,0 cm, 8" **03-11-210-20**  
 23,0 cm, 9" **03-11-210-23**  
 25,0 cm, 10" **03-11-210-25**

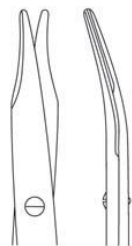

14,5 cm, 5<sup>3</sup>/<sub>4</sub>" **03-11-211-14**  
 16,0 cm, 6<sup>1</sup>/<sub>4</sub>" **03-11-211-16**  
 18,0 cm, 7" **03-11-211-18**



**REYNOLDS**



**FOMON SPEZIAL**  
 13,5 cm, 4<sup>3</sup>/<sub>8</sub>"  
**03-11-013-13**





Feine chirurgische Scheren  
Fine surgical scissors  
Fins Ciseaux chirurgicaux  
Tijeras fi nas para cirugia  
Тонкие хирургические ножницы



18,0 cm, 7" 03-11-217-18  
23,0 cm, 10" 03-11-217-23  
25,0 cm, 10" 03-11-217-25

THOREK



15,0 cm, 6"

03-11-220-15

03-11-221-15

Nerv-Präparierscheren  
Nerve dissecting scissors  
Ciseaux pour nerfs  
Tijeras para nervios  
Ножницы для сухожилия



SANVENERO  
14,0 cm, 5½"

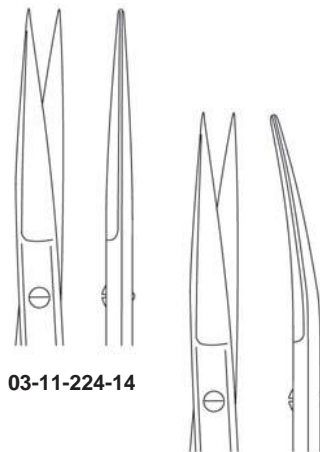

03-11-224-14

03-11-225-14

extra flache Blätter  
extra flat blades  
lames extrêmement plat  
hojas muy delgadas  
особо плоские бранши



JOSEPH  
14,0 cm, 5½"

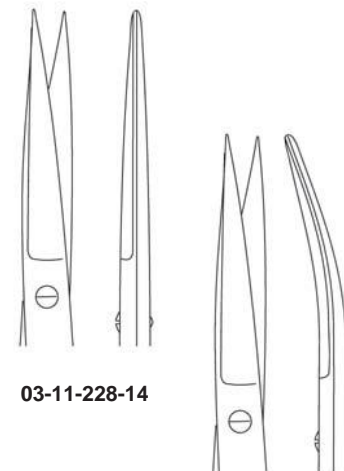

03-11-228-14

03-11-229-14

Feine chirurgische Scheren  
 Fine surgical scissors  
 Fins ciseaux chirurgicaux  
 Tijeras finas para cirugía  
 Тонкие хирургические ножницы

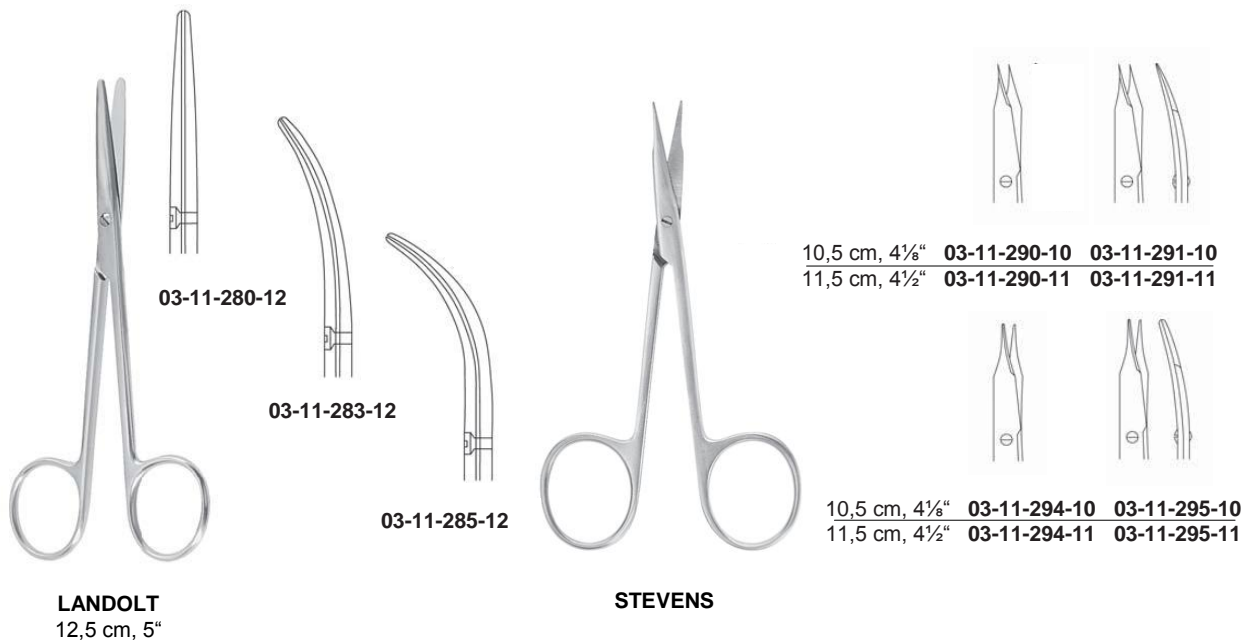



Feine chirurgische Scheren  
Fine surgical scissors  
Fins ciseaux chirurgicaux  
Tijeras finas para cirugía  
Тонкие хирургические ножницы



9,0 cm, 3½" 03-11-244-09  
10,5 cm, 4⅛" 03-11-244-10  
11,5 cm, 4½" 03-11-244-11

IRIS

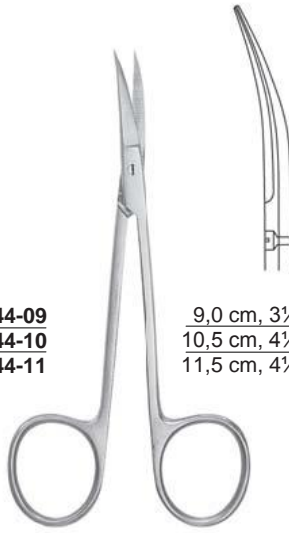

9,0 cm, 3½" 03-11-245-09  
10,5 cm, 4⅛" 03-11-245-10  
11,5 cm, 4½" 03-11-245-11

IRIS



10,5 cm, 4⅛" 03-11-250-10  
11,5 cm, 4½" 03-11-250-11

IRIS



10,5 cm, 4⅛" 03-11-251-10  
11,5 cm, 4½" 03-11-251-11

IRIS



IRIS  
11,5 cm, 4½"  
03-11-261-11



IRIS  
11,5 cm, 4½"  
03-11-263-11

**Feine chirurgische Scheren**  
**Fine surgical scissors**  
**Fins ciseaux chirurgicaux**  
**Tijeras finas para cirugía**  
**Тонкие хирургические ножницы**



03-11-264-12

12,0 cm, 4¾"



03-11-265-12



**MOD. BONN**  
 8,0 cm, 3¼"  
 03-11-270-08



**MOD. BONN**  
 8,0 cm, 3¼"  
 03-11-271-08



**MOD. BONN**  
 8,0 cm, 3¼"  
 03-11-272-08



Chirurgische Scheren, Feine chirurgische Scheren  
Surgical scissors, Fine surgical scissors  
Ciseaux chirurgicaux, Fins ciseaux chirurgicaux  
Tijeras para cirugía, Tijeras finas para cirugía  
Хирургические ножницы, тонкие хирургические ножницы



**BROPHY (SULLIVAN)**  
FLACHSCHLUSS  
14,0 cm, 5½"  
03-11-276-14



**BROPHY (SULLIVAN)**  
FLACHSCHLUSS  
14,0 cm, 5½"  
03-11-277-14



Inzisionsscheren  
Incisionscissors  
Ciseaux a incision  
Tijeras para incisión  
Ножницы для рассечения  
тканей

13,0 cm, 5" 03-11-300-13  
14,5 cm, 5¾" 03-11-300-14  
16,0 cm, 6½" 03-11-300-16  
16,5 cm, 6¾" 03-11-302-16



**FERGUSSON**  
16,5 cm, 6¼" 03-11-315-16  
18,0 cm, 7" 03-11-315-18



**TOENNIS**  
18,0 cm, 7"  
03-11-324-18



**TOENNIS**  
18,0 cm, 7"  
03-11-325-18

Ligaturscheren, Neurochirurgische Scheren  
 Ligature Scissors, Neurosurgical Scissors  
 Ciseaux a sutures, Ciseaux neurochirurgicaux  
 Tijeras para ligaduras, Tijeras para Neurocirugia  
 Ножницы лигатурные, нейрохирургические ножницы



**SHORTHBENT**  
 9,0 cm, 3½"  
 03-11-411-09



**NORTHBENT**  
 12,5 cm, 4¾"  
 03-11-413-13



**EISELSBERG**  
 12,0 cm, 4¾"  
 03-11-415-12



03-11-450-22

**STRULLY**  
 22,0 cm, 8¾"  
 03-11-450-22

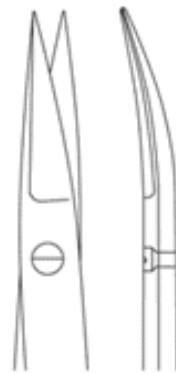

03-11-452-22

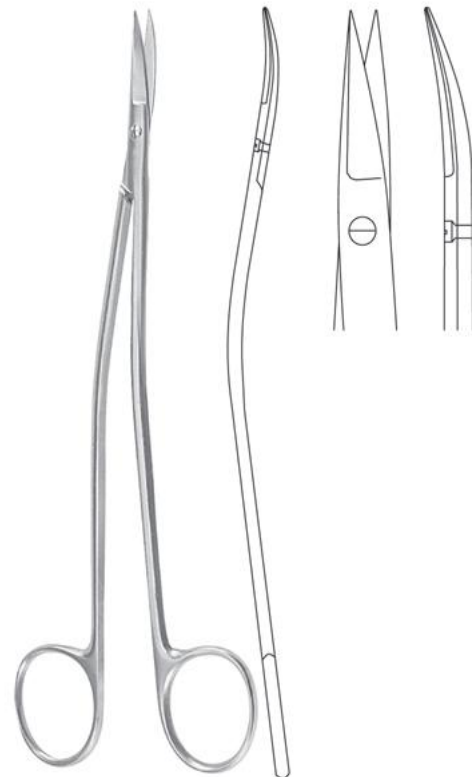

**DANDY**  
 17,0 cm, 6¾"  
 03-11-453-17



Chirurgische Scheren, Ligaturscheren  
Surgical scissors, Ligature Scissors  
Ciseaux chirurgicaux, Ciseaux a sutures  
Tijeras para cirugía, Tijeras para ligaduras  
Ножницы хирургические, лигатурные ножницы



**HALLE**  
14,0 cm, 5½" 03-11-341-14  
19,0 cm, 7½" 03-11-341-19



**FOMON**  
13,0 cm, 5"  
03-11-343-13



**FOMON SABER BACK**  
13,5 cm, 5"  
03-11-015-13



**SPENCER**  
9,0 cm, 4⅜" 03-11-400-09  
11,0 cm, 4⅝" 03-11-400-11  
12,0 cm 5" 03-11-398-12  
12,5 cm 5⅞" 03-11-400-12  
16,0 cm, 6½" 03-11-400-16



**LITTAUER**  
14,0 cm, 5½" 03-11-402-14  
16,0 cm, 6¼" 03-11-402-16

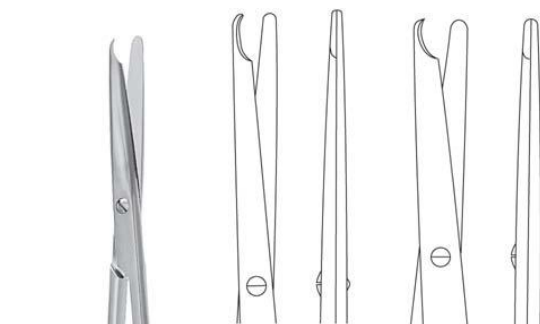

14,5 cm, 5¾"  
03-11-404-14

18,0 cm, 7"  
03-11-404-18



**BUCK**



Tonsillenscheren, Nasenscheren, Neurochirurgische Scheren  
 Tonsil Scissors, Nasal Scissors Neurosurgical Scissors  
 Ciseaux amygdaliens, Ciseaux à énucléation et nasaux, Ciseaux neurochirurgicaux  
 Tijeras para amígdalas, Tijeras para el tabique nasal, Tijeras para Neurocirugía  
 Ножницы для миндалин, носовые ножницы, нейрохирургические ножницы

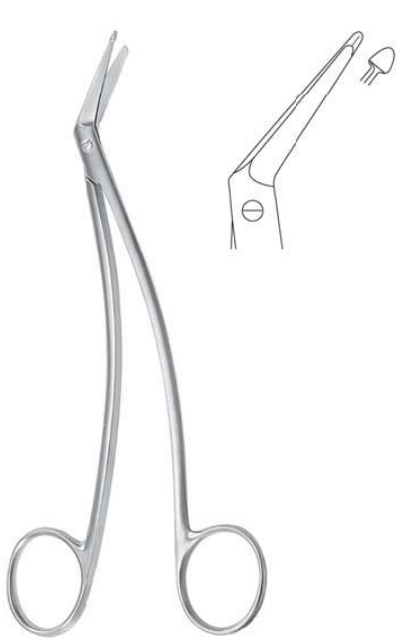

**SCHMIEDEN-TAYLOR**  
 14,5 cm, 5¾" **03-11-501-18**  
 17,0 cm, 6¾" **03-11-457-17**



**LINCOLN**  
 17,0 cm, 6¾"



**HEYMANN**  
 18,0 cm, 7" **03-11-501-18**  
 19,0 cm, 7½" **03-11-501-19**

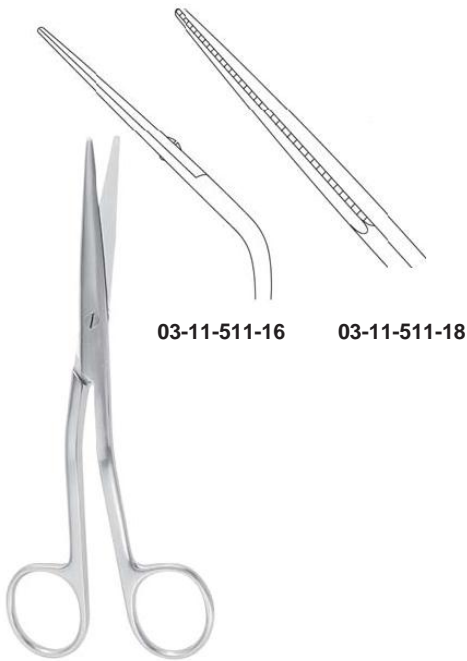

**COTTLE**  
 16,0 cm, 6¼"



**HEYMANN  
 WELLENSCHLIFF**  
 18,0 cm, 7" **03-11-517-18**  
 19,0 cm, 7½" **03-11-517-19**



**CAPLAN**  
 22,0 cm, 8⅝"  
**03-11-519-22**



Tonsillenscheren, Nasenscheren, Gefäßscheren  
 Tonsil Scissors, Nasal Scissors, Vascular Scissors  
 Ciseaux amygdaliens, Ciseaux a énucléation et nasaux, Ciseaux vasculaires  
 Tijeras para amígdalas, Tijeras para el tabique nasal, Tijeras vasculares  
 Ножницы для миндалин, носовые ножницы, ножницы для кровеносных сосудов



**BOETTCHER**  
 18,0 cm, 7"  
 03-11-521-18



**PRINCE**  
 17,5 cm, 6 7/8"  
 03-11-523-17



**GOOD**  
 19,0 cm, 7 1/2"



**CARTILAGE**  
 20,0 cm, 8"  
 03-11-528-20

gezahnt  
 serrated  
 dentèles  
 dentada  
 зазубренные

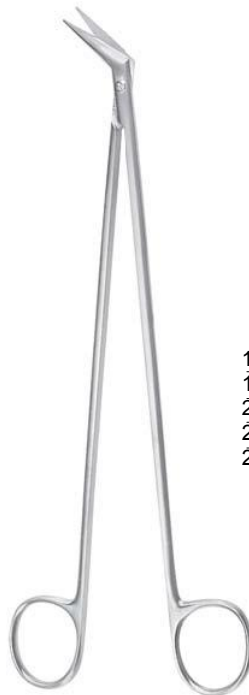

**DE BAKEY**

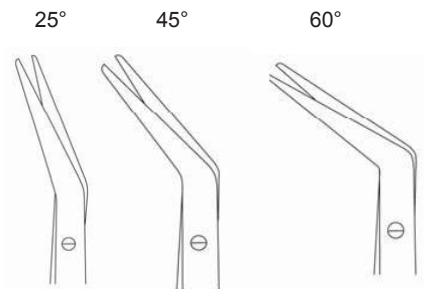

17,5 cm, 6 7/8"	03-11-540-25	03-11-540-45	03-11-540-60
19,5 cm, 7"	03-11-541-25	03-11-541-45	03-11-541-60
21,0 cm, 8 1/4"	03-11-543-25	03-11-543-45	-
23,0 cm, 9"	03-11-544-25	03-11-544-45	03-11-544-60
28,0 cm, 11"	03-11-545-25	03-11-545-45	03-11-545-60

Gefäßscheren  
 Vascular Scissors  
 Ciseaux vasculaires  
 Tijeras vasculares  
 Ножницы для сосудов



**DIETHRICH**  
 17,0 cm, 6¾"  
 03-11-552-12

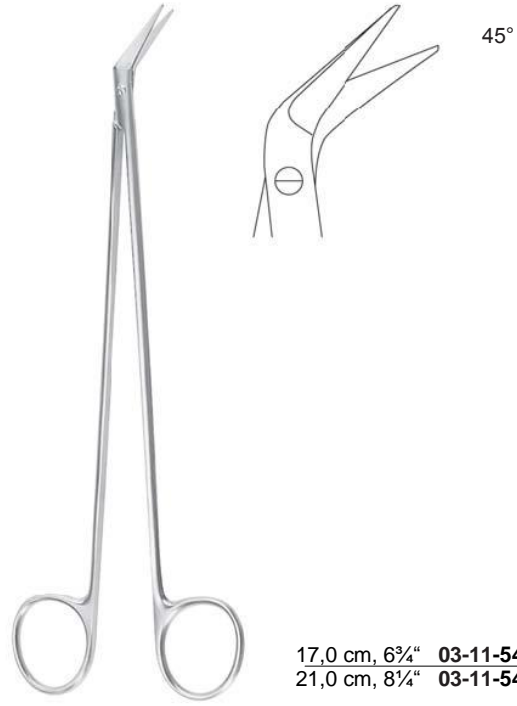

**POTTS DE MARTEL**

17,0 cm, 6¾" 03-11-548-17  
 21,0 cm, 8¼" 03-11-548-21



**DIETHRICH-HEGEMANN**

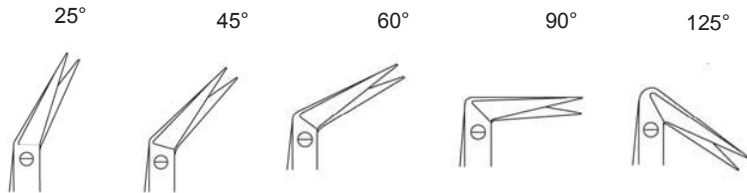

	25°	45°	60°	90°	125°
13,0 cm, 5"	03-11-550-25	03-11-550-45	03-11-550-60	03-11-550-90	-
13,5 cm, 5 ¼"	03-11-563-25	03-11-563-45	03-11-563-60	03-11-563-90	-
16,0 cm, 6 ¼"	03-11-550-25.1	03-11-550-45.1	03-11-550-60.1	03-11-550-90.1	03-11-550-12.1
19,0 cm, 7 ½"	03-11-550-25.2	03-11-550-45.2	03-11-550-60.2	03-11-550-90.2	03-11-550-12.2

Gefäßscheren  
Vascular Scissors  
Ciseaux vasculaires  
Tijeras vasculares  
Ножницы для сосудов

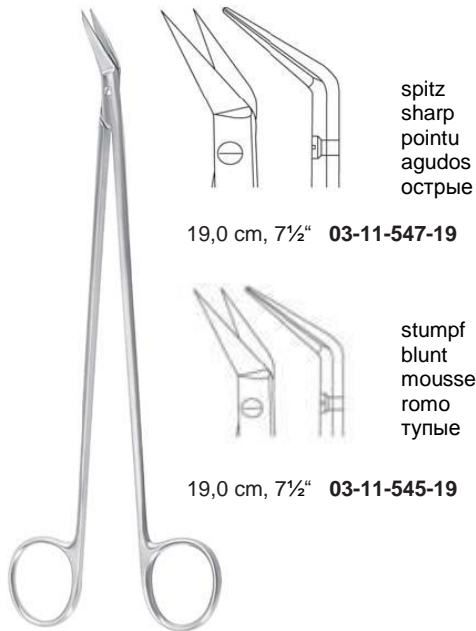

19,0 cm, 7½" 03-11-547-19

19,0 cm, 7½" 03-11-545-19

POTTS-SMITH



25°

16,0 cm, 6½" 03-11-552-25  
19,0 cm, 7½" 03-11-553-25



45°

03-11-553-45

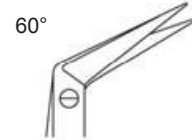

60°

03-11-553-60

POTTS-SMITH  
19,0 cm, 7½"



25°

DE BAKEY  
15,5 cm, 6¼"  
03-11-560-15



45°

DE BAKEY  
15,5 cm, 6¼"  
03-11-561-15

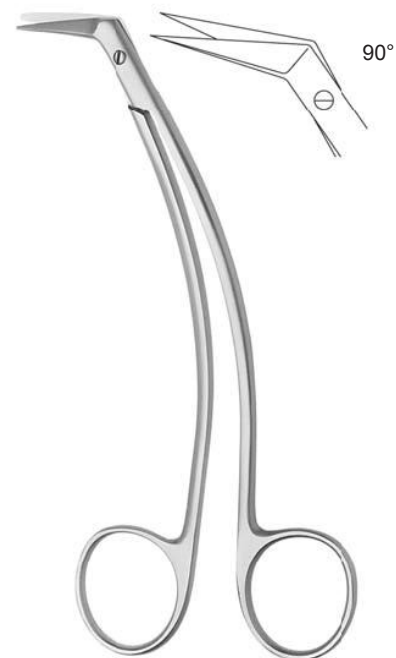

90°

FAVALORO  
15,0 cm, 6"  
03-11-562-15

Gefäßscheren, Gynäkologische Scheren  
 Vascular Scissors, Gynecological scissors  
 Ciseaux vasculaires, Ciseaux gynécologiques  
 Tijeras vasculares, Tijeras para ginecología  
 Ножницы для сосудов, гинекологические ножницы



**MC INDOE**  
 19,0 cm, 7½"  
 03-11-570-19



11,5 cm, 4½"  
 03-11-572-11

geknöpftes Blatt  
 probe-pointed blade  
 una lame boutonnée  
 punta botonda  
 застегивающиеся  
 лезвия



**CRAFOORD**  
 30,0 cm, 12"  
 03-11-575-30



**SATINSKY**  
 25,0 cm, 10"  
 03-11-577-25



**KLINGENBERG-LOTH**  
 23,0 cm, 9"  
 03-11-579-23



**SIMS**

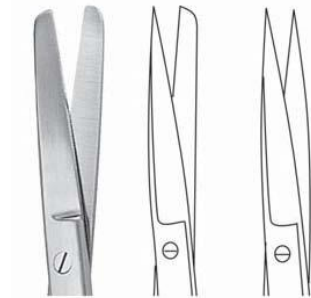

20,0 cm, 8"	03-11-600-20	03-11-602-20	03-11-604-20
21,5 cm, 8½"	03-11-600-21	03-11-602-21	03-11-604-21
23,0 cm, 9"	03-11-600-23	03-11-602-23	03-11-604-23



**SIMS**



gebogen, curved, arquée, curva, изогнутые

20,0 cm, 8" 03-11-601-20 03-11-603-20 03-11-605-20  
23,0 cm, 9" 03-11-601-23 03-11-603-23 03-11-605-23



**SIEBOLD**  
24,0 cm, 9½"  
03-11-620-24



**DOYEN**



16,0 cm, 6¼" 03-11-610-16 03-11-611-16 03-11-612-16  
17,5 cm, 6⅞" 03-11-610-17 03-11-611-17 -



**BOZEMANN**  
22,0 cm, 8¾"  
03-11-622-22

Gynäkologische Scheren, Dammscheren  
 Gynecological scissors, Enterotomy Scissors  
 Ciseaux gynécologiques, Ciseaux intestinaux  
 Tijeras para ginecología, Tijeras enterótomos  
 Ножницы гинекологические, ножницы кишечные



Fistelscheren  
 Fistula scissors  
 Ciseaux a fistules  
 Tijeras para fi stulas  
 Ножницы для фистулы

**KELLY**  
 16,0 cm, 6¼" **03-11-634-16**  
 18,0 cm, 7" **03-11-634-18**  
**TC**  
 16,0 cm, 6¼" **03-12-634-16**



Fistelscheren  
 Fistula scissors  
 Ciseaux a fistules  
 Tijeras para fi stulas  
 Ножницы для фистулы

**KELLY**  
 16,0 cm, 6¼" **03-11-635-16**  
 18,0 cm, 7" **03-11-635-18**  
**TC**  
 16,0 cm, 6¼" **03-12-635-16**



**03-11-651-27**  
 gebogen  
 curved  
 arquée  
 curva  
 изогнутые

**DUBOIS**  
 27,0 cm, 10⅝"  
**03-11-650-27**



**LLOYD-DAVIES**  
 27,0 cm, 10⅝"  
**03-11-677-27**



21,0 cm, 8¼"  
**03-11-670-21**



21,0 cm, 8¼"  
**03-11-672-21**



21,0 cm, 8¼"  
**03-11-674-21**



Lungenlappen- und Rektumscheren, Lungenscheren, Dammscheren  
Lobectomy and Rectal Scissors, Lobectomy Scissors, Episiotomy Scissors  
Lobectomie et rectale ciseaux, Ciseaux intestinaux, Episiotomy Scissors,  
Tijeras para lobectomía y recto, Tijera para lobectomía, Tijeras para episiotomía  
Ножницы ректальные, ножницы для лобэктомии, ножницы для легких



**STELZNER**  
31,0 cm, 12¼"  
03-11-681-31



**RECTAL**  
30,5 cm, 11½" 03-11-685-30  
32,5 cm 12¾" 03-11-685-32



**WILLAUER**  
25,0 cm, 9¾" 03-11-688-25  
28,0 cm, 11" 03-11-688-28



**WILLAUER**  
25,0 cm, 9¾" 03-11-689-25  
28,0 cm, 11" 03-11-689-28



**POTTS-SMITH**  
19,0 cm, 7½"  
03-11-691-19



**FINOCHIETTO**  
32,5 cm, 10¾"  
03-11-693-32



Lungenscheren, Dammscheren, Nabelschnurscheren  
 Lobectomy Scissors, Episiotomy Scissors, Umbilical Cord Scissors  
 Lobectomie ciseaux, Ciseaux intestinaux, Ciseaux ombilicales  
 Tijera para lobectomia, Tijeras para episiotomía, Tijeras umbilicales  
 Ножницы для лобэктомии и эпизиотомии, ножницы для обрезания пуповины



**WALDMANN**  
 18,0 cm, 7"  
 03-11-695-18



**BRAUN-STADLER**  
 14,5 cm, 5 $\frac{3}{4}$ " 03-11-701-14  
 20,0 cm, 8" 03-11-701-20  
 22,0 cm, 8 $\frac{5}{8}$ " 03-11-701-22



20,0 cm, 8"  
 03-11-703-20



**MOD. USA**  
 10,5 cm, 4 $\frac{1}{8}$ "  
 03-11-706-10



**BUSCH**  
 13,5 cm, 5 $\frac{3}{8}$ " 03-11-707-13  
 16,0 cm, 6 $\frac{1}{4}$ " 03-11-707-16



**SCHUMACHER**  
 16,0 cm, 16 $\frac{1}{4}$ "  
 03-11-709-16



Drahtscheren, Verband- und Kleiderstoffscheren  
 Wire Scissors, Bandage and Cloth Scissors  
 Ciseaux a Fils, Ciseaux a Bandages, Ciseaux a Gaze  
 Cizallas corta-alambres, Tijeras para vendajes y tela  
 Ножницы для проволоки, ножницы для повязок



gezahnt  
 serrated  
 dentelée  
 dentada  
 зазубренные

**UNIVERSAL**  
 12,0 cm, 4<sup>3</sup>/<sub>4</sub>"  
 03-11-800-12



**LISTER**

- 9,0 cm, 3<sup>1</sup>/<sub>2</sub>" 03-11-900-09
- 11,0 cm, 4<sup>3</sup>/<sub>4</sub>" 03-11-900-11
- 14,0 cm, 5<sup>1</sup>/<sub>2</sub>" 03-11-900-14
- 16,0 cm, 6<sup>1</sup>/<sub>4</sub>" 03-11-900-16
- 18,0 cm, 7" 03-11-900-18
- 20,0 cm, 8" 03-11-900-20



**LISTER**  
 18,5 cm, 7<sup>1</sup>/<sub>4</sub>" 03-11-901-18  
 21,0 cm, 8<sup>1</sup>/<sub>4</sub>" 03-11-901-21



**LISTER-EXCENTRIC**  
 16,0 cm, 6<sup>1</sup>/<sub>4</sub>" 03-11-903-16  
 19,0 cm, 7<sup>1</sup>/<sub>2</sub>" 03-11-903-19

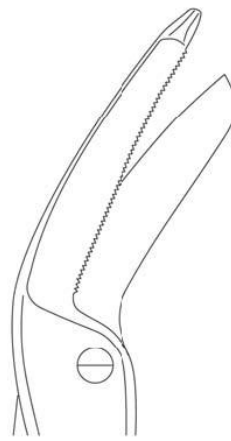

gezahnt  
 serrated  
 dentelée  
 dentada  
 зазубренные



**BERGMANN**  
 23,0 cm, 9"  
 03-11-905-23

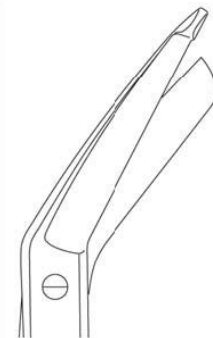

**Verband- und Kleiderstoffscheren, Gipsscheren**  
**Bandage and Cloth Scissors, Plaster-of-Paris Shears**  
**Ciseaux a Bandages, Ciseaux a Gaze, Ciseaux a Plâtre**  
**Tijeras para vendajes y tela, Cizallas para escayolas**  
**Ножницы для повязок, ножницы для гипсовых повязок**

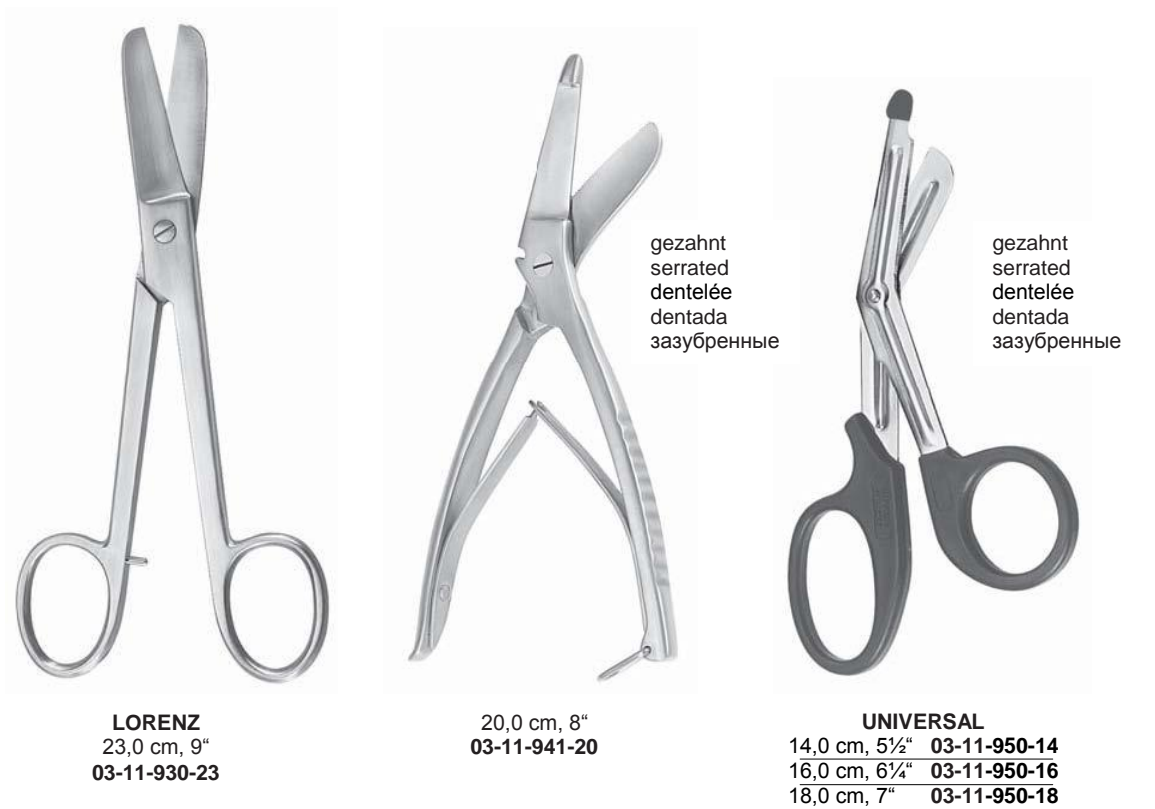



Chirurgische Scheren mit Hartmetallschneiden  
Surgical Scissors with tungsten carbide edges  
Ciseaux chirurgicaux, tranchant TC  
Tijeras para cirugía con fi los de carburo tungsteno  
Ножницы хирургические с твердосплавной вставкой



**STANDARD**  
14,5 cm, 5¾" 03-12-000-14  
16,5 cm, 6½" 03-12-000-16  
18,5 cm, 7¼" 03-12-000-18



**STANDARD**  
14,5 cm, 5¾" 03-12-001-14  
16,5 cm, 6½" 03-12-001-16  
18,5 cm, 7¼" 03-12-001-18



**STANDARD**  
14,5 cm, 5¾" 03-12-002-14  
16,5 cm, 6½" 03-12-002-16  
18,5 cm, 7¼" 03-12-002-18



**STANDARD**  
14,5 cm, 5¾" 03-12-003-14  
16,5 cm, 6½" 03-12-003-16  
18,5 cm, 7¼" 03-12-003-18



**STANDARD**  
14,5 cm, 5¾" 03-12-004-14  
16,5 cm, 6½" 03-12-004-16  
18,5 cm, 7¼" 03-12-004-18



**STANDARD**  
14,5 cm, 5¾" 03-12-005-14  
16,5 cm, 6½" 03-12-005-16  
18,5 cm, 7¼" 03-12-005-18

Chirurgische Scheren mit Hartmetallschneiden  
 Surgical Scissors with tungsten carbide edges  
 Ciseaux chirurgicaux, tranchant TC  
 Tijeras para cirugía con fi los de carburo tungsteno  
 Ножницы хирургические с твердосплавной вставкой



**MAYO**  
 14,5 cm, 5<sup>3</sup>/<sub>4</sub>" 03-12-100-14  
 16,0 cm, 6<sup>1</sup>/<sub>4</sub>" 03-12-100-16  
 17,0 cm, 6<sup>3</sup>/<sub>4</sub>" 03-12-100-17  
 19,0 cm, 7<sup>1</sup>/<sub>4</sub>" 03-12-100-19  
 23,0 cm, 9" 03-12-100-23



**MAYO**  
 14,5 cm, 5<sup>3</sup>/<sub>4</sub>" 03-12-101-14  
 16,0 cm, 6<sup>1</sup>/<sub>4</sub>" 03-12-101-16  
 17,0 cm, 6<sup>3</sup>/<sub>4</sub>" 03-12-101-17  
 19,0 cm, 7<sup>1</sup>/<sub>4</sub>" 03-12-101-19  
 23,0 cm, 9" 03-12-101-23



**MAYO-STILLE**  
 15,0 cm, 6" 03-12-102-15  
 17,0 cm, 6<sup>3</sup>/<sub>4</sub>" 03-12-102-17



**MAYO-STILLE**  
 15,0 cm, 6" 03-12-103-15  
 17,0 cm, 6<sup>3</sup>/<sub>4</sub>" 03-12-103-17



**LEXER**  
 16,0 cm, 6<sup>1</sup>/<sub>4</sub>" 03-12-140-16  
 21,0 cm, 8<sup>1</sup>/<sub>4</sub>" 03-12-140-21



**LEXER**  
 16,0 cm, 6<sup>1</sup>/<sub>4</sub>" 03-12-141-16  
 21,0 cm, 8<sup>1</sup>/<sub>4</sub>" 03-12-141-21



Präparierscheren mit Hartmetallschneiden  
Dissecting Scissors with tungsten carbide edges  
Ciseaux à dissection, tranchant TC  
Tijeras para disección con fi los de carburo tungsteno  
Ножницы анатомические с твердосплавной вставкой



03-12-110-11



**BABY-METZENBAUM**  
11,5 cm, 4½"



03-12-110-14



**METZENBAUM**  
14,5 cm, 5¾"



03-12-112-18



**METZENBAUM**  
18,0 cm, 7"



03-12-111-11



03-12-111-14



03-12-113-18

03-12-114-14



- 18,0 cm, 7" 03-12-110-18
- 20,0 cm, 8" 03-12-110-20
- 23,0 cm, 9" 03-12-110-23
- 25,0 cm, 10" 03-12-110-25
- 28,0 cm, 11" 03-12-110-28
- 30,0 cm, 12" 03-12-110-30



- 18,0 cm, 7" 03-12-111-18
- 20,0 cm, 8" 03-12-111-20
- 23,0 cm, 9" 03-12-111-23
- 25,0 cm, 10" 03-12-111-25
- 28,0 cm, 11" 03-12-111-28
- 30,0 cm, 12" 03-12-111-30

03-12-115-14



**METZENBAUM**  
14,5 cm, 5¾"



**METZENBAUM**



**METZENBAUM**

**Präparierscheren mit Hartmetallschneiden**  
**Dissecting Scissors with tungsten carbide edges**  
**Ciseaux à dissection, tranchant TC**  
**Tijeras para disección con fi los de carburo tungsteno**  
**Ножницы анатомические с твердосплавной вставкой**



**METZENBAUM**



18,0 cm, 7" **03-12-114-18**  
 20,0 cm, 8" **03-12-114-20**  
 23,0 cm, 9" **03-12-114-23**



**METZENBAUM**



18,0 cm, 7" **03-12-115-18**  
 20,0 cm, 8" **03-12-115-20**  
 23,0 cm, 9" **03-12-115-23**



**METZENBAUM-FINO**  
 14,5 cm, 5¾"

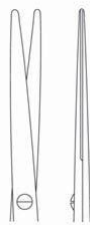

**03-12-120-14**



**03-12-121-14**



**METZENBAUM-FINO**  
 14,5 cm, 5¾"



**03-12-124-14**



**03-12-125-14**





Präparierscheren mit Hartmetallschneiden  
Dissecting Scissors with tungsten carbide edges  
Ciseaux à dissection, tranchant TC  
Tijeras para disección con fi los de carburo tungsteno  
Ножницы анатомические с твердосплавной вставкой

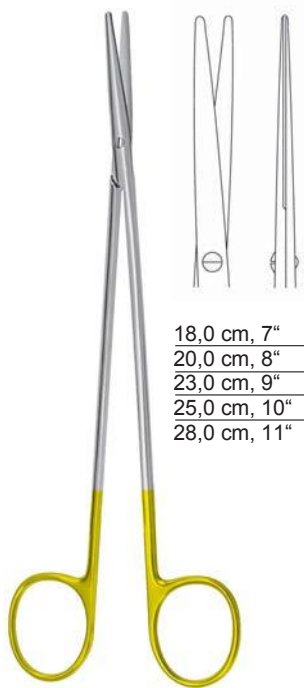

18,0 cm, 7" 03-12-120-18  
20,0 cm, 8" 03-12-120-20  
23,0 cm, 9" 03-12-120-23  
25,0 cm, 10" 03-12-120-25  
28,0 cm, 11" 03-12-120-28

METZENBAUM-FINO

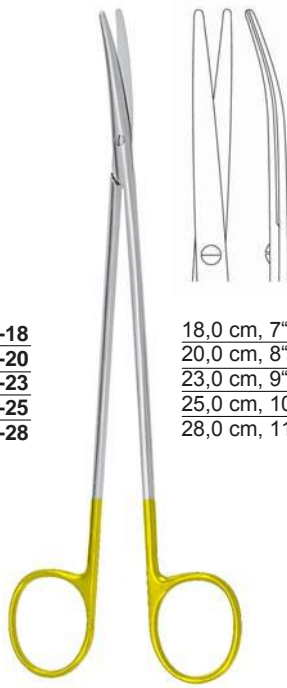

18,0 cm, 7" 03-12-121-18  
20,0 cm, 8" 03-12-121-20  
23,0 cm, 9" 03-12-121-23  
25,0 cm, 10" 03-12-121-25  
28,0 cm, 11" 03-12-121-28

METZENBAUM-FINO



18,0 cm, 7" 03-12-124-18  
20,0 cm, 8" 03-12-124-20  
23,0 cm, 9" 03-12-124-23

METZENBAUM-FINO



18,0 cm, 7" 03-12-125-18  
20,0 cm, 8" 03-12-125-20  
23,0 cm, 9" 03-12-125-23

METZENBAUM-FINO

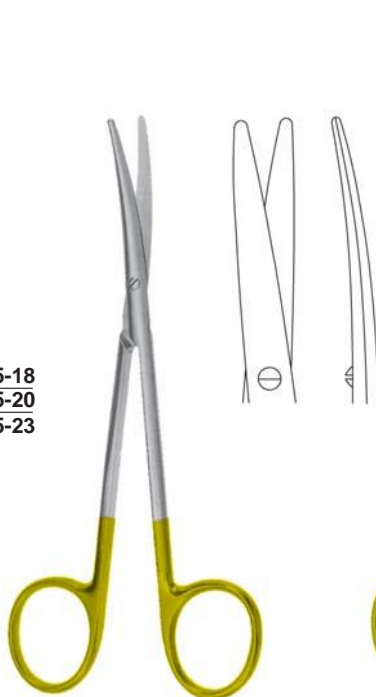

METZENBAUM-LAHEY  
14,0 cm, 5½"  
03-12-137-14



TOENNIS-ADSON  
17,0 cm, 6¾"  
03-12-139-17

**Präparierscheren mit Hartmetallschneiden**  
**Dissecting Scissors with tungsten carbide edges**  
**Ciseaux à dissection, tranchant TC**  
**Tijeras para disección con fi los de carburo tungsteno**  
**Ножницы анатомические с твердосплавной вставкой**

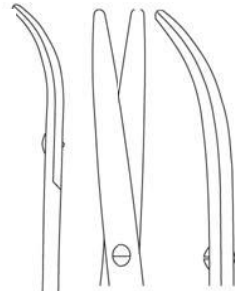

18,0 cm, 7" **03-12-127-18**  
 20,0 cm, 8" **03-12-127-20**  
 23,0 cm, 9" **03-12-127-23**

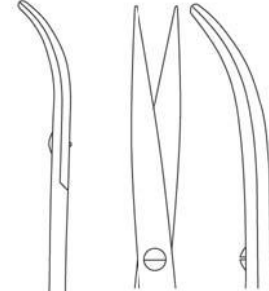

18,0 cm, 7" **03-12-129-18**  
 20,0 cm, 8" **03-12-129-20**  
 23,0 cm, 9" **03-12-129-23**

**METZENBAUM-FINO S**

**METZENBAUM-FINO S**



**HYSTEREKTOMY**  
 25,0 cm, 10"  
**03-12-663-25**



**HYSTEREKTOMY**  
 27,0 cm, 10½"  
**03-12-665-27**

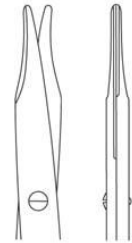

15,0 cm, 6" **03-12-210-15**



14,5 cm, 5¾" **03-12-211-14**  
 18,0 cm, 7" **03-12-211-18**

**REYNOLDS**





Gynäkologische Scheren mit Hartmetallschneiden  
Gynecological scissors with tungsten carbide edges  
Ciseaux gynécologiques, tranchant TC  
Tijeras para ginecología con fi los de carburo tungsteno  
Ножницы гинекологические с твердосплавной вставкой



SIMS



20,0 cm, 8" 03-12-600-20 03-12-602-20 03-12-604-20  
23,0 cm, 9" 03-12-600-23 03-12-602-23 03-12-604-23



SIMS

gebogen, curved, arquée, curva, изогнутые

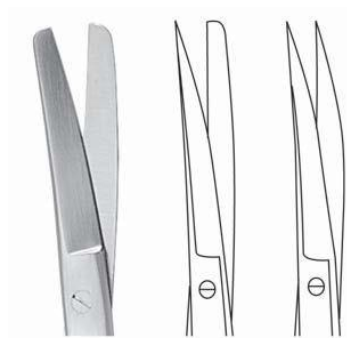

20,0 cm, 8" 03-12-601-20 03-12-603-20 03-12-605-20  
23,0 cm, 9" 03-12-601-23 03-12-603-23 03-12-605-23

Gefäßscheren mit Hartmetallschneiden  
 Vascular Scissors with tungsten carbide edges  
 Ciseaux vasculaires, tranchant TC  
 Tijeras vasculares con fi los de carburo tungsteno  
 Ножницы для кровеносных сосудов с твердосплавной вставкой



125°

**DIETRICH**  
 19,0 cm, 7½"  
 03-12-552-19



45°

**POTTS DE MARTEL**  
 19,0 cm, 7½"  
 03-12-548-19



25°

45°

60°

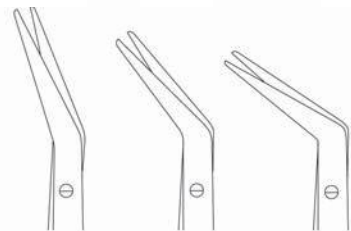

16,5 cm, 6½"	03-12-541-16	03-12-543-16	03-12-545-16
19,0 cm, 7½"	03-12-541-19	03-12-543-19	03-12-545-19
21,0 cm, 8¼"	03-12-541-21	03-12-543-21	03-12-545-21
23,0 cm, 9"	03-12-541-23	03-12-543-23	03-12-545-23
28,0 cm; 11"	03-12-541-28	03-12-543-28	03-12-545-28

**DE BAKEY**



Gefäßscheren mit Hartmetallschneiden  
 Vascular Scissors with tungsten carbide edges  
 Ciseaux vasculaires, tranchant TC  
 Tijeras vasculares con fi los de carburo tungsteno  
 Ножницы для кровеносных сосудов с твердосплавной вставкой

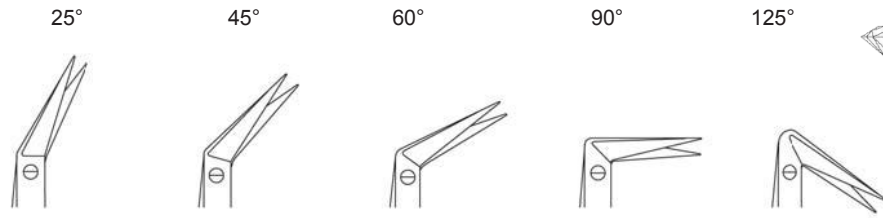

	25°	45°	60°	90°	125°
18,0 cm, 7"	03-12-550-25.1	03-12-550-45.1	03-12-550-60.1	03-12-550-90.1	03-12-550-12.1
19,0 cm, 7½"	03-12-550-25	03-12-550-45	03-12-550-60	03-12-550-90	

Gezahnt serrated dentelée dentada зазубренные

	25°	45°	60°	90°	125°
18,0 cm, 7"	03-12-550-25.1Z	03-12-550-45.1Z	03-12-550-60.1Z	03-12-550-90.1Z	03-12-550-12.1Z

DIETHRICH-HEGEMANN



	25°	45°	60°
	03-12-551-25	03-12-551-45	03-12-551-60

POTTS-SMITH  
 19,0 cm, 7½"

Scheren mit Hartmetallschneide  
 Scissors with tungsten carbide edges  
 Ciseaux tranchant TC  
 Tijeras con fi los de carburo tungsteno  
 Ножницы с твердосплавной вставкой



spitz / spitz  
 sharp / sharp  
 pointu / pointu  
 agudos / agudos  
 острые / острые

03-12-244-11    03-12-245-11    03-12-248-11

spitz / stumpf  
 sharp / blunt  
 pointu / mousse  
 agudos / romo  
 острые / тупые

03-12-246-11    03-12-247-11

gezahnt  
 serrated  
 dentelée  
 dentada  
 зазубренные

**IRIS**  
 11,5 cm, 4½"

**UNIVERSAL**  
 12,0 cm, 4¾"  
 03-12-800-12

gezahnt  
 serrated  
 dentelée  
 dentada  
 зазубренные

**LISTER**  
 18,0 cm, 7"    03-12-900-18  
 20,0 cm, 8"    03-12-900-20

**BRUNS**  
 24,0 cm, 9½"  
 03-12-909-24



Super-Cut Scheren  
Super-Cut Scissors  
Ciseaux Supercut  
Tijeras Super-Cut  
Супер-острые ножницы



14,5 cm, 5¾" 03-13-100-14 03-13-101-14  
17,0 cm, 6¾" 03-13-100-17 03-13-101-17  
23,0 cm, 9" 03-13-100-23 03-13-101-23

MAYO



14,5 cm, 5¾" 03-13-111-14  
18,0 cm, 7" 03-13-111-18  
20,0 cm, 8" 03-13-111-20  
23,0 cm, 9" 03-13-111-23  
25,0 cm, 10" 03-13-111-25  
28,0 cm, 11" 03-13-111-28  
30,0 cm, 12" 03-13-111-30

METZENBAUM



14,5 cm, 5¾" 03-13-121-14  
18,0 cm, 7" 03-13-121-18  
20,0 cm, 8" 03-13-121-20  
23,0 cm, 9" 03-13-121-23  
25,0 cm, 10" 03-13-121-25  
28,0 cm, 11" 03-13-121-28  
30,0 cm, 12" 03-13-121-30

METZENBAUM-FINO



15,0 cm, 6" 03-13-129-15  
19,0 cm, 7½" 03-13-129-19

KAYE FACE LIFT

Super-Cut Scheren  
 Super-Cut Scissors  
 Ciseaux Supercut  
 Tijeras Super-Cut  
 Супер-острые ножницы



**JABALEY**  
 12,0 cm, 4¾"  
 03-13-130-12



**ENDARTERECTOMY**  
 18,0 cm, 7"  
 03-13-133-18



**TOENNIS-ADSON**  
 17,5 cm, 6⅝"  
 03-13-139-17



**STRABISMUS**  
 11,5 cm, 4½"

03-13-240-11



03-13-241-11



**JAMISON**

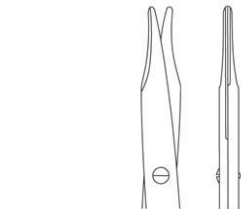

14,0 cm, 5½" 03-13-218-14  
 18,0 cm, 7" 03-13-218-18



14,0 cm, 5½" 03-13-219-14  
 18,0 cm, 7" 03-13-219-18



Super-Cut Scheren  
Super-Cut Scissors  
Ciseaux Supercut  
Tijeras Super-Cut  
Супер-острые ножницы



**REYNOLDS**  
15,0 cm, 5" 03-13-210-15  
18,0 cm, 7" 03-13-210-18



**BABY-METZENBAUM**  
12,0 cm, 4¾"

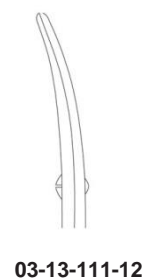
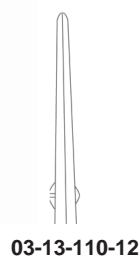

**IRIS**  
9,5 cm, 3¾" 03-13-244-09  
11,5 cm, 4½" 03-13-244-11



**IRIS**  
9,5 cm, 3¾" 03-13-245-09  
11,5 cm, 4½" 03-13-245-11



**STEVENS TENOTOMY**  
10,5 cm, 4⅛" 03-13-290-10  
11,5 cm, 4½" 03-13-290-11



**STEVENS TENOTOMY**  
10,5 cm, 4⅛" 03-13-291-10  
11,5 cm, 4½" 03-13-291-11

Super-Cut Scheren  
 Super-Cut Scissors  
 Ciseaux Supercut  
 Tijeras Super-Cut  
 Супер-острые ножницы



**KILNER**  
 12,5 cm, 4¾"  
 03-13-200-12



**KILNER**  
 12,5 cm, 4¾"  
 03-13-201-12



**HEGELMANN**  
 19,0 cm, 7½"

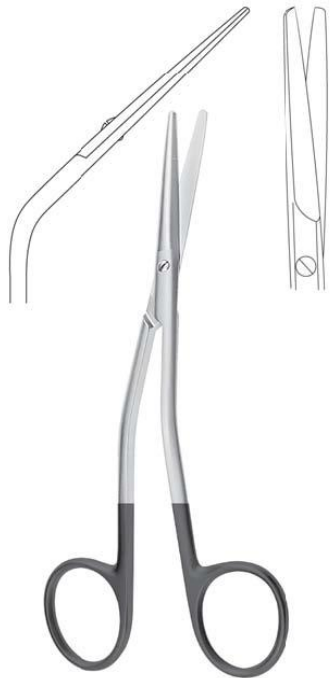
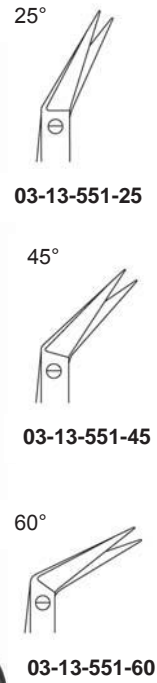

**FOMON**  
 14,0 cm, 5½"  
 03-13-343-14



**COTTLE**  
 16,5 cm, 6¼"  
 03-13-511-16





Präparierscheren  
Dissecting Scissors  
Ciseaux à dissection  
Tijeras de disección  
Ножницы анатомические



LITTLER

Super-Cut

11,8 cm, 4 <sup>3</sup> / <sub>4</sub> "	03-11-0253-11	03-13-0253-11
14,0 cm, 5 <sup>1</sup> / <sub>2</sub> "	03-11-0253-14	03-13-0253-14
18,0 cm, 7"	03-11-0253-18	



MILLS  
03-11-455-21  
22,5 cm



MAYO-HARRINGTON  
23,0 cm

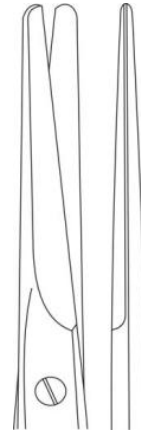

03-11-108-23



03-11-109-23

Feine chirurgische Scheren  
 Fine surgical scissors  
 Fins ciseaux chirurgicaux  
 Tijeras finas para cirugía  
 Тонкие хирургические ножницы



**WILMER**  
 10,0 cm  
 03-11-0255-10



**LA GRANGE**  
 11,5 cm

gezahnt  
 serrated  
 dentelée  
 dentada  
 зазубренные

03-11-0257-11

03-11-0258-11



**RIBBON**  
 9,5 cm  
 03-11-268-01

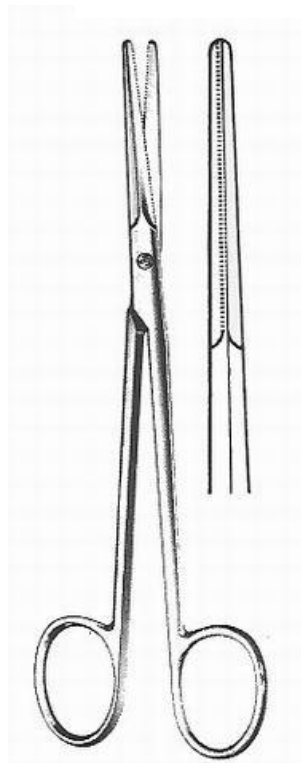

**BEUSE**  
 14,0 cm 03-11-330-14  
 18,0 cm 03-11-330-18

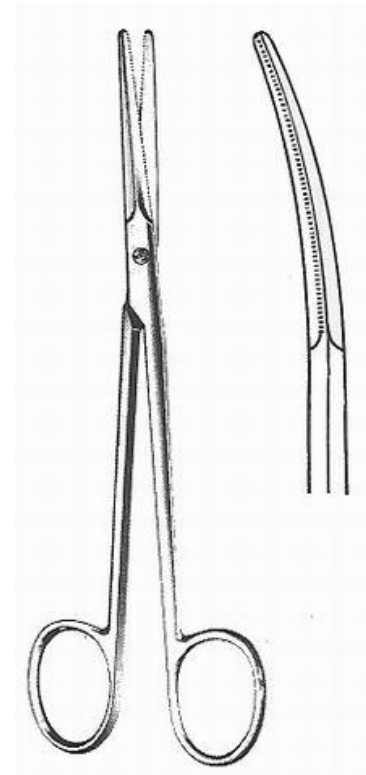

**BEUSE**  
 14,0 cm 03-11-331-14  
 18,0 cm 03-11-331-18



Chirurgische Scheren  
Surgical scissors  
Ciseaux chirurgicaux  
Tijeras para cirugía  
Хирургические ножницы



**LOCKLIN**  
16,0 cm  
03-11-532-16



**LOCKLIN**  
16,0 cm  
03-11-534-16  
TC 03-12-534-16  
SC 03-13-534-16



**LOCKLIN**  
16,0 cm  
03-11-535-16  
TC 03-12-535-16  
SC 03-13-535-16



**FAVALORO**  
16,0 cm 03-11-563-16



Leicht  
Medizintechnik

**Mikro-Scheren  
Micro Scissors  
Micro-Ciseaux  
Micro-Tijeras  
Микро-ножницы**







Mikro-Scheren  
Micro-Scissors  
Micro-Ciseaux  
Micro-Tijeras  
Микро-ножницы

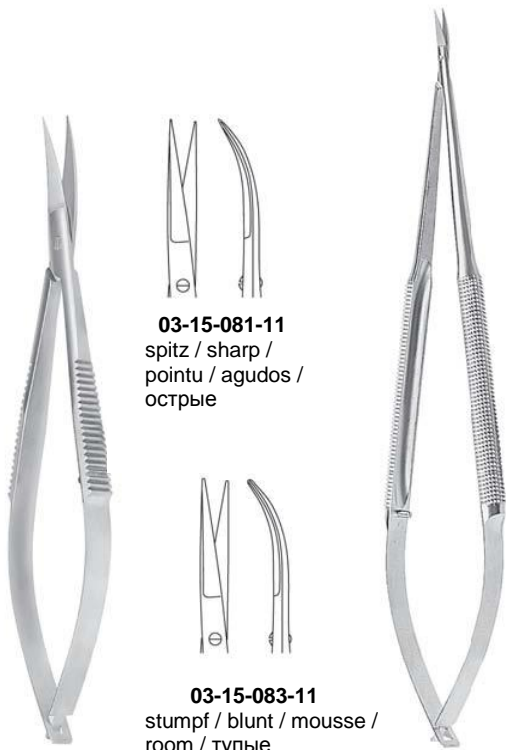

**WESTCOTT**  
11,0 cm, 4 3/8"

**GOMEL**

**03-15-081-11**  
spitz / sharp /  
pointu / agudos /  
острые

**03-15-083-11**  
stumpf / blunt / mousse /  
room / тупые

14 mm

9 mm



Gezahnt / serrated / dentelée / dentada / зазубренные

15,0 cm, 6" **03-15-240-15Z** **03-15-241-15Z** **03-15-242-15Z** **03-15-243-15Z**  
18,0 cm, 7" **03-15-240-18Z** **03-15-241-18Z** **03-15-243-18Z** **03-15-241-18Z**

14 mm

9 mm



Glatt / smath / lisses / lisas / гладкие

15,0 cm, 6" **03-15-240-15** **03-15-241-15** **03-15-242-15** **03-15-243-15**  
18,0 cm, 7" **03-15-240-18** **03-15-241-18** **03-15-243-18** **03-15-241-18**



**HEPP SCHEIDEL**

Mikro-Präparierscheren  
Micro, dissecting scissors  
Micro-Ciseaux a dissection  
Micro-tijeras de disección  
Микро-анатомические ножницы

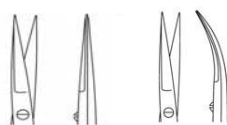

Gezahnt / serrated / dentelée / dentada / зазубренные

15,0 cm, 6" **315-244-15Z** **315-245-15Z**  
18,0 cm, 7" **315-244-18Z** **315-245-18Z**

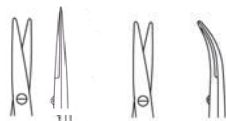

Glatt / smath / lisses / lisas / гладкие

15,0 cm, 6" **03-15-244-15** **03-15-245-15**  
18,0 cm, 7" **03-15-244-18** **03-15-245-18**



18,0 cm, 7"



**03-15-246-01**



**03-15-246-02**



**03-15-246-03**

**Mikro-Scheren, Mikro-Disektionsscheren  
 Micro-Scissors, Micro Dissecting Scissors  
 Micro-Ciseaux, Micro-Ciseaux a dissection  
 Micro-Tijeras, Micro-Tijeras de disección  
 Микро-ножницы, микро-анатомические ножницы**



18,0 cm, 7"

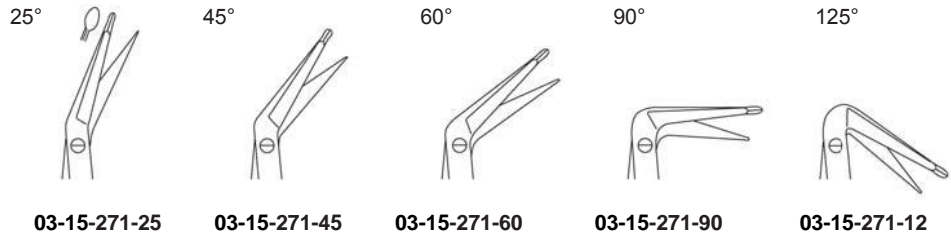
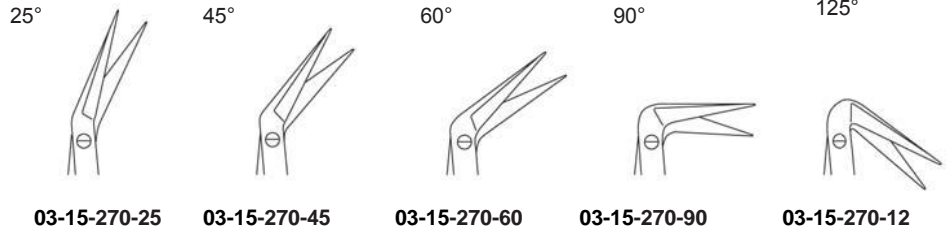

15,0 cm, 6"  
 03-15-223-15



15,0 cm, 6"  
 03-15-223-15Z



gezahnt  
 serrated  
 dentelée  
 dentada  
 зазубренные



15,0 cm, 6"  
 03-15-201-15

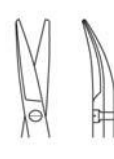

18,0 cm, 7"  
 03-15-201-18

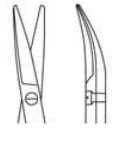





Mikro-Adventitiascheren  
Micro Adventitia Scissors  
Micro-Ciseaux Adventitia  
Micro-Tijeras Adventitia  
Микро-ножницы для соединительной ткани



15,0 cm, 6"  
03-15-232-15



15,0 cm, 6"  
03-15-232-15Z



gezahnt  
serrated  
dentelée  
dentada  
зззубренные



15,0 cm, 6"  
03-15-203-15

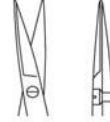

18,0 cm, 7"  
03-15-203-18



STEVENS



18,5 cm, 7¼" 03-15-290-01 03-15-290-02 03-15-290-03 03-15-290-04  
22,0 cm, 8¾" 03-15-291-01 03-15-291-02 03-15-291-03 03-15-291-04



18,5 cm, 7¼" 03-15-292-01 03-15-292-02  
22,5 cm, 8¾" 03-15-293-01 03-15-293-02



**Mikro-Adventitiascheren**  
**Micro Adventitia Scissors**  
**Micro-Ciseaux Adventitia**  
**Micro-Tijeras Adventitia**  
**Микро-ножницы для соединительной ткани**



Adventitia /  
Adventitia /  
адвентина

Präparation /  
Dissection /  
диссекция

**Blatt / Blade / лезвия 10 mm**

15 cm / 6"	<b>03-1730-15</b>	<b>03-1735-15</b>	<b>03-1740-15</b>	<b>03-1745-15</b>
18 cm / 7"	<b>03-1730-18</b>	<b>03-1735-18</b>	<b>03-1740-18</b>	<b>03-1745-18</b>
21 cm / 8 1/4"	<b>03-1730-21</b>	<b>03-1735-21</b>	<b>03-1740-21</b>	<b>03-1745-21</b>
23 cm / 9"	<b>03-1730-23</b>	<b>03-1735-23</b>	<b>03-1740-23</b>	<b>03-1745-23</b>



25°



45°



60°



90°



125°

**Blatt / Blade / лезвия 7 mm**

18 cm / 7"	<b>03-1711-18</b>	<b>03-1713-18</b>	<b>03-1714-18</b>	<b>03-1716-18</b>	<b>03-1719-18</b>
------------	-------------------	-------------------	-------------------	-------------------	-------------------

**Blatt / Blade / лезвия 10 mm**

18 cm / 7"	<b>03-1721-18</b>	<b>03-1723-18</b>	<b>03-1724-18</b>	<b>03-1726-18</b>	<b>03-1729-18</b>
------------	-------------------	-------------------	-------------------	-------------------	-------------------



25°



45°



60°



90°



125°

**Blatt / Blade / лезвия 10 mm**

18 cm / 7"	<b>03-1731-18</b>	<b>03-1733-18</b>	<b>03-1734-18</b>	<b>03-1736-18</b>	<b>03-1739-18</b>
------------	-------------------	-------------------	-------------------	-------------------	-------------------



**Blatt / Blade / лезвия 11 mm**

12 cm / 4 3/4"	<b>03-1125-12</b>	<b>03-1127-12</b>
15 cm / 6"	<b>03-1125-15</b>	<b>03-1127-15</b>

18 cm / 7"	<b>03-1125-18</b>	<b>03-1127-81</b>
------------	-------------------	-------------------

**Blatt / Blade / лезвия 5 mm**

12 cm / 4 3/4"	<b>03-1135-12</b>	<b>03-1137-12</b>
----------------	-------------------	-------------------

15 cm / 6"	<b>03-1135-15</b>	<b>03-1137-15</b>
------------	-------------------	-------------------

18 cm / 7"	<b>03-1135-18</b>	<b>03-1137-18</b>
------------	-------------------	-------------------



25°



45°



60°



90°



125°

**Blatt / Blade / лезвия 11 mm**

18 cm / 7"	<b>03-1221-18</b>	<b>03-1223-18</b>	<b>03-1224-18</b>	<b>03-1226-18</b>	<b>03-1229-18</b>
------------	-------------------	-------------------	-------------------	-------------------	-------------------

**Blade 15 mm**

18 cm / 7"	<b>03-1121-18</b>	<b>03-1123-18</b>	<b>03-1124-18</b>	<b>03-1126-18</b>	<b>03-1129-18</b>
------------	-------------------	-------------------	-------------------	-------------------	-------------------



25°



45°



60°



90°



125°

**Blatt / Blade / лезвия 11 mm**

18 cm / 7"	<b>03-1231-18</b>	<b>03-1233-18</b>	<b>03-1234-18</b>	<b>03-1236-18</b>	<b>03-1239-18</b>
------------	-------------------	-------------------	-------------------	-------------------	-------------------

**Blatt / Blade / лезвия 15 mm**

18 cm / 7"	<b>03-1131-18</b>	<b>03-1133-18</b>	<b>03-1134-18</b>	<b>03-1136-18</b>	<b>03-1139-18</b>
------------	-------------------	-------------------	-------------------	-------------------	-------------------

Mikro Scheren  
 Micro Scissors  
 Micro-Ciseaux  
 Micro-Tijeras  
 Микро-ножницы



CASTROVIEJO



<b>Blatt / Blade / лезвия 9 mm</b>		
15 cm / 6"	<b>03-1604-15</b>	<b>03-1609-15</b>
18 cm / 7"	<b>03-1604-18</b>	<b>03-1609-18</b>



<b>Blatt / Blade / лезвия 14 mm</b>		
15 cm / 6"	<b>03-1600-15</b>	<b>03-1605-15</b>
18 cm / 7"	<b>03-1600-18</b>	<b>03-1605-18</b>



CASTROVIEJO

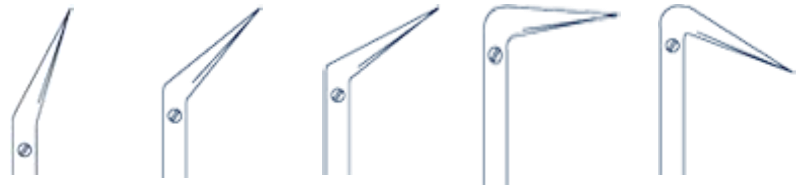

<b>Blatt / Blade / лезвия 11 mm</b>					
	25°	45°	60°	90°	125°
18 cm / 7"	<b>03-1621-18</b>	<b>03-1623-18</b>	<b>03-1624-18</b>	<b>03-1626-18</b>	<b>03-1629-18</b>

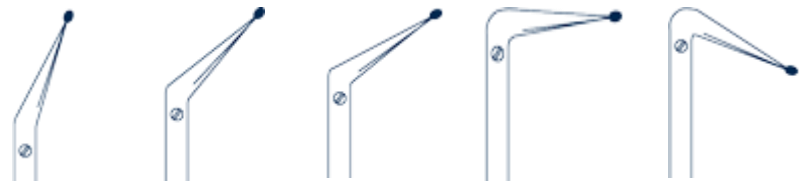

<b>Blatt / Blade / лезвия 11 mm</b>					
	25°	45°	60°	90°	125°
18 cm / 7"	<b>03-1641-18</b>	<b>03-1643-18</b>	<b>03-1644-18</b>	<b>03-1646-18</b>	<b>03-1649-18</b>



Mikro Scheren  
Micro Scissors  
Micro-Ciseaux  
Micro-Tijeras  
Микро-ножницы



**BIEMER**

13 cm / 5" 03-1758-13



**BARRAQUER**

22 cm / 8 1/2"



03-1130-22



03-1137-22



03-1132-22



**BARRAQUER**



Adventitia / Adventitia /  
адвентина

Präparation / Dissection /  
диссекция

**Blatt / Blade / лезвия 9 mm**

12 cm / 4 3/4" 03-1804-12 03-1809-12 03-1894-12 03-1899-12

15 cm / 6" 03-1804-15 03-1809-15 03-1894-15 03-1899-15

18 cm / 7" 03-1804-18 03-1809-18 03-1894-18 03-1899-18

**Blatt / Blade / лезвия 14 mm**

12 cm / 4 3/4" 03-1800-12 03-1805-12 03-1890-12 03-1895-12

15 cm / 6" 03-1800-15 03-1805-15 03-1890-15 03-1895-15

18 cm / 7" 03-1800-18 03-1805-18 03-1890-18 03-1895-18

gezahnt / toothed / зазубренные

Adventitia / Adventitia /  
адвентина

Präparation / Dissection /  
диссекция

**Blatt / Blade / лезвия 9 mm**

12 cm / 4 3/4" 03-1806-12 03-1810-12 03-1896-12 03-1891-12

15 cm / 6" 03-1806-15 03-1810-15 03-1896-15 03-1891-15

18 cm / 7" 03-1806-18 03-1810-18 03-1896-18 03-1891-18

**Blatt / Blade / лезвия 14 mm**

12 cm / 4 3/4" 03-1802-12 03-1807-12 03-1892-12 03-1897-12

15 cm / 6" 03-1802-15 03-1807-15 03-1892-15 03-1897-15

18 cm / 7" 03-1802-18 03-1807-18 03-1892-18 03-1897-18

Mikro Scheren  
 Micro Scissors  
 Micro-Ciseaux  
 Micro-Tijeras



STREAMLINE



Adventitia / Adventitia /  
 адвентина

Präparation / Dissection /  
 диссекция

Blatt / Blade / лезвия 10 mm

15 cm / 6"	03-1900-15	03-1905-15	03-1920-15	03-1925-15
18 cm / 7"	03-1900-18	03-1905-18	03-1920-18	03-1925-18
21 cm / 8 1/4"	03-1900-21	03-1905-21	03-1920-21	03-1925-21

Blatt / Blade / лезвия 10 mm

25°	45°	60°	90°	125°	
18 cm / 7"	03-1921-18	03-1923-18	03-1924-18	03-1926-18	03-1929-18
21 cm / 8 1/4"	03-1921-21	03-1923-21	03-1924-21	03-1926-21	03-1929-21

Blatt / Blade / лезвия 10 mm

25°	45°	60°	90°	125°	
18 cm / 7"	03-1941-18	03-1943-18	03-1944-18	03-1946-18	03-1949-18
21 cm / 8 1/4"	03-1941-21	03-1943-21	03-1944-21	03-1946-21	03-1949-21



BARRAQUER

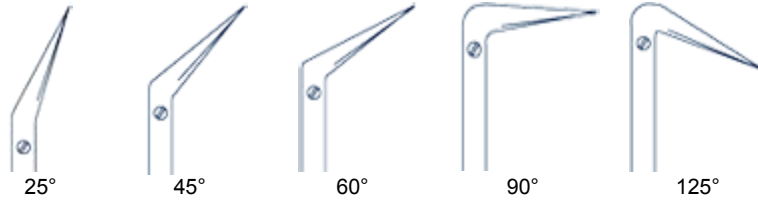

<b>Blatt / Blade / лезвия 7 mm</b> 18 cm / 7"	<b>03-1811-18</b>	<b>03-1813-18</b>	<b>03-1814-18</b>	<b>03-1816-18</b>	<b>03-1819-18</b>
<b>Blatt / Blade / лезвия 10 mm</b> 18 cm / 7"	<b>03-1821-18</b>	<b>03-1823-18</b>	<b>03-1824-18</b>	<b>03-1826-18</b>	<b>03-1829-18</b>



<b>Blatt / Blade / лезвия 10 mm</b> 18 cm / 7"	<b>03-1841-18</b>	<b>03-1843-18</b>	<b>03-1844-18</b>	<b>03-1846-18</b>	<b>03-1849-18</b>
---	-------------------	-------------------	-------------------	-------------------	-------------------



<b>Blatt / Blade / лезвия 7 mm</b> 16,5 cm / 6 1/2"	<b>03-1 881-16T</b>	<b>03-1 887-16T</b>
<b>Blatt / Blade / лезвия 10 mm</b> 16,5 cm / 6 1/2"	<b>03-1 882-16T</b>	<b>03-1 888-16T</b>
<b>Blatt / Blade / лезвия 14 mm</b> 16,5 cm / 6 1/2"	<b>03-1 883-16T</b>	<b>03-1 889-16T</b>

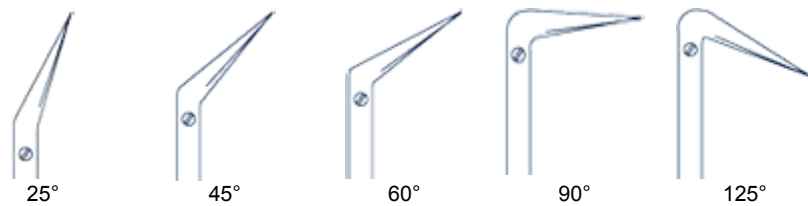

<b>Blatt / Blade / лезвия 7 mm</b> 16,5 cm / 6 1/2"	<b>03-1 506-16T</b>	<b>03-1 507-16T</b>	<b>03-1 508-16T</b>	<b>03-1 509-16T</b>	<b>03-1 510-16T</b>
<b>Blatt / Blade / лезвия 10 mm</b> 16,5 cm / 6 1/2"	<b>03-1 476-16T</b>	<b>03-1 477-16T</b>	<b>03-1 478-16T</b>	<b>03-1 479-16T</b>	<b>03-1 480-16T</b>
<b>Blatt / Blade / лезвия 14 mm</b> 16,5 cm / 6 1/2"	<b>03-1 482-16T</b>	<b>03-1 483-16T</b>	<b>03-1 484-16T</b>	<b>03-1 485-16T</b>	<b>03-1 486-16T</b>

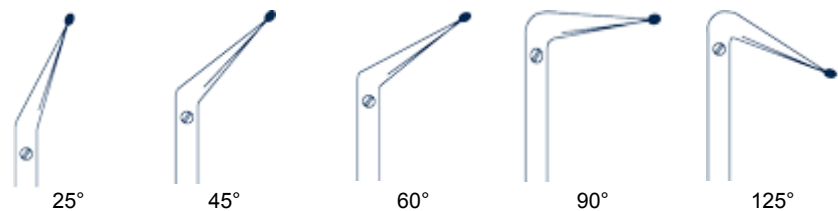

<b>Blatt / Blade / лезвия 14 mm</b> 16,5 cm / 6 1/2"	<b>03-1 489-16T</b>	<b>03-1 490-16T</b>	<b>03-1 491-16T</b>	<b>03-1 492-16T</b>	<b>03-1 493-16T</b>
---	---------------------	---------------------	---------------------	---------------------	---------------------



Mikro Scheren  
 Micro Scissors  
 Micro-Ciseaux  
 Micro-Tijeras  
 Микро-ножницы



YASARGIL

Blatt / Blade / лезвия 14 mm



gerade/straight/  
 прямые



aufgebogen/curved up/  
 изогнутые вперед



zurückgebogenen/curved  
 down/ изогнутые назад

16 cm / 6 1/4"  
 20 cm / 8"

03-1106-16  
 03-1106-20

03-1107-16  
 03-1107-20

—  
 03-1105-20

Blatt / Blade / лезвия 27 mm

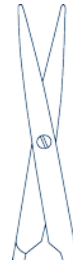

gerade/straight/  
 прямые



aufgebogen/curved up/  
 изогнутые вперед

16 cm / 6 1/4"  
 18 cm / 7"  
 20 cm / 8"

03-1102-16  
 03-1102-18  
 03-1102-20

03-1103-16  
 03-1103-18  
 03-1103-20



YASARGIL  
 23 cm / 9"



03-1110-23



03-1115-23



YASARGIL  
 23 cm / 9"



03-1112-23



03-1117-23

VANNAS-Blatt /  
 Blade / лезвия



Blatt / Blade / лезвия 27 mm



**YASARGIL**  
23 cm / 9"



gerade/straight/  
прямые

03-1102-23



aufgebogen/curved up/  
изогнутые вперед

03-1103-23

Blatt / Blade / лезвия 14 mm

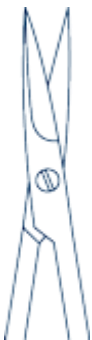

gerade/straight/  
прямые

03-1106-23



aufgebogen/curved up/  
изогнутые вперед

03-1107-23



zurückgebogenen/curved  
down/ изогнутые назад

03-1105-23



**VANNAS**

03-1108-23



**VANNAS**  
aufgebogen/curved up/  
изогнутые вперед

03-1109-23



**Pinzetten  
Forceps  
Pincers  
Pinzas  
Пинцеты**









**STANDARD**

10,5 cm, 4 $\frac{1}{8}$ " **05-16-002-10**  
11,5 cm, 4 $\frac{1}{2}$ " **05-16-002-11**  
13,0 cm, 5" **05-16-002-13**  
14,5 cm, 5 $\frac{3}{4}$ " **05-16-002-14**  
16,0 cm, 6 $\frac{1}{4}$ " **05-16-002-16**  
18,0 cm, 7" **05-16-002-18**  
20,0 cm, 8" **05-16-002-20**  
25,0 cm, 10" **05-16-002-25**  
30,0 cm, 12" **05-16-002-30**



schmal  
narrow  
étroite  
estrechos  
узкие

**STANDARD**

10,5 cm, 4 $\frac{1}{8}$ " **05-16-003-10**  
11,5 cm, 4 $\frac{1}{2}$ " **05-16-003-11**  
13,0 cm, 5" **05-16-003-13**  
14,5 cm, 5 $\frac{3}{4}$ " **05-16-003-14**  
16,0 cm, 6 $\frac{1}{4}$ " **05-16-003-16**  
18,0 cm, 7" **05-16-003-18**  
20,0 cm, 8" **05-16-003-20**  
25,0 cm, 10" **05-16-003-25**  
30,0 cm, 12" **05-16-003-30**



schmal  
narrow  
étroite  
estrechos  
узкие

**STANDARD**

10,5 cm, 4 $\frac{1}{8}$ " **05-16-004-10**  
11,5 cm, 4 $\frac{1}{2}$ " **05-16-004-11**  
13,0 cm, 5" **05-16-004-13**  
14,5 cm, 5 $\frac{3}{4}$ " **05-16-004-14**  
16,0 cm, 6 $\frac{1}{4}$ " **05-16-004-16**  
18,0 cm, 7" **05-16-004-18**  
20,0 cm, 8" **05-16-004-20**  
25,0 cm, 10" **05-16-004-25**  
30,0 cm, 12" **05-16-004-30**



fein  
fine  
fin  
finas  
тонкие

**STANDARD**

10,5 cm, 4 $\frac{1}{8}$ " **05-16-010-10**  
11,5 cm, 4 $\frac{1}{2}$ " **05-16-010-11**  
13,0 cm, 5" **05-16-010-13**  
14,5 cm, 5 $\frac{3}{4}$ " **05-16-010-14**  
16,0 cm, 6 $\frac{1}{4}$ " **05-16-010-16**  
18,0 cm, 7" **05-16-010-18**  
20,0 cm, 8" **05-16-010-20**  
25,0 cm, 10" **05-16-010-25**

Anatomische Pinzetten  
 Dissecting Forceps  
 Pincers a dissection  
 Pinzas de disección  
 Пинцеты анатомические



fein  
 fine  
 fin  
 finas  
 тонкие

- 10,5 cm, 4<sup>1</sup>/<sub>8</sub>" 05-16-011-10
- 11,5 cm, 4<sup>1</sup>/<sub>2</sub>" 05-16-011-11
- 13,0 cm, 5" 05-16-011-13
- 14,5 cm, 5<sup>3</sup>/<sub>4</sub>" 05-16-011-14
- 16,0 cm, 6" 05-16-011-16
- 18,0 cm, 7" 05-16-011-18
- 20,0 cm, 8" 05-16-020-20
- 25,5 cm, 10" 05-16-025-25
- 30,0 cm, 12" 05-16-030-30



MOD. USA

- 12,0 cm, 4<sup>3</sup>/<sub>4</sub>" 05-16-006-12
- 13,0 cm, 5" 05-16-006-13
- 14,5 cm, 5<sup>3</sup>/<sub>4</sub>" 05-16-006-14
- 15,0 cm, 6" 05-16-006-15
- 18,0 cm, 7" 05-16-006-18
- 20,0 cm, 8" 05-16-006-20
- 25,5 cm, 10" 05-16-006-25
- 30,0 cm, 12" 05-16-006-30



schmal  
 narrow  
 étroite  
 estrechos  
 узкие

MOD. USA

- 12,0 cm, 4<sup>3</sup>/<sub>4</sub>" 05-16-012-11
- 13,0 cm, 5" 05-16-012-13
- 14,5 cm, 5<sup>3</sup>/<sub>4</sub>" 05-16-012-14
- 15,0 cm, 6" 05-16-012-15

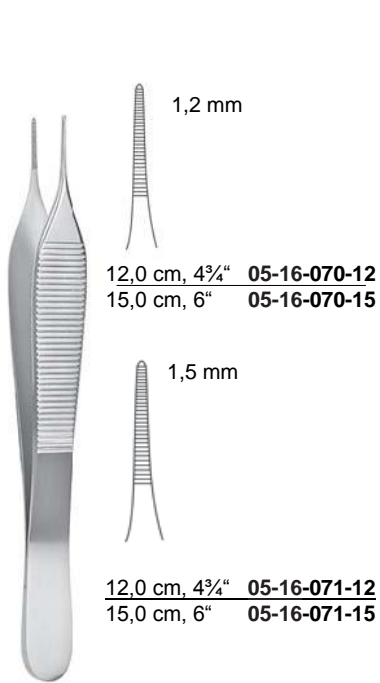

**ADSON**



**MICRO-ADSON**  
12,0 cm, 4<sup>3</sup>/<sub>4</sub>" 05-16-076-12  
15,0 cm, 6" 05-16-076-15

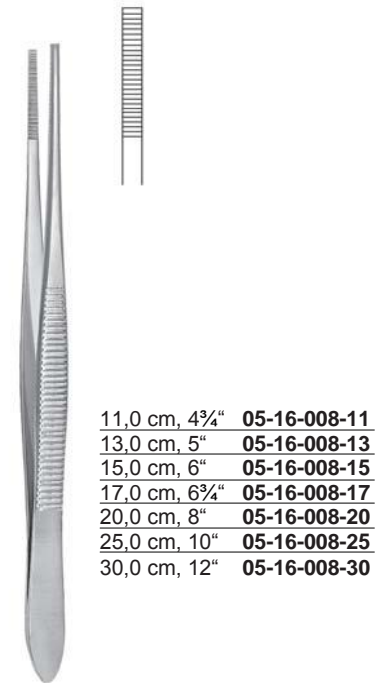

**STILLE**



**MC INDOE**  
15,0 cm, 6"  
05-16-158-15



**TAYLOR**  
17,5 cm, 6<sup>7</sup>/<sub>8</sub>"  
05-16-114-17



**TAYLOR**  
17,5 cm, 6<sup>7</sup>/<sub>8</sub>"  
05-16-115-17



**TAYLOR**  
17,0 cm, 6<sup>3</sup>/<sub>4</sub>" 05-16-117-17  
20,0 cm, 8" 05-16-117-20



**GERALD**  
18,0 cm, 7"  
05-16-102-18

Anatomische Pinzetten  
 Dissecting Forceps  
 Pincés a dissection  
 Pinzas de disección  
 Пинцеты анатомические



**GERALD**  
 18,0 cm, 7"  
**05-16-103-18**



**POTTS-SMITH**  
 18,0 cm, 7" **05-16-026-18**  
 21,0 cm, 8¼" **05-16-026-21**  
 23,0 cm, 9" **05-16-026-23**  
 25,0 cm, 10" **05-16-026-25**  
 30,0 cm, 12" **05-16-026-30**



**POTTS-SMITH**  
 18,0 cm, 7" **05-16-027-18**  
 21,0 cm, 8¼" **05-16-027-21**  
 25,0 cm, 10" **05-16-027-25**  
 30,0 cm, 12" **05-16-027-30**



englische Modelle  
 english patterns  
 modèle anglais  
 modelos ingleses  
 английская модель

13,0 cm, 5" **05-16-036-13**  
 14,5 cm, 5¾" **05-16-036-14**  
 15,0 cm, 6" **05-16-036-15**



**SEMKEN**

12,5 cm, 4¾" **05-16-040-12**  
 15,0 cm, 6" **05-16-040-15**

12,5 cm, 4¾" **05-16-041-12**  
 15,0 cm, 6" **05-16-041-15**



**CUSHING**  
 17,5 cm, 6⅝" **05-16-092-17**  
 20,0 cm, 8" **05-16-092-20**



**CUSHING**  
 17,5 cm, 6⅝" **05-16-093-17**



Anatomische Pinzetten  
Dissecting Forceps  
Pinces a dissection  
Pinzas de disección  
Пинцеты анатомические



**BROPHY**  
20,0 cm, 8"  
05-16-094-20



**BROPHY**  
20,0 cm, 8"  
05-16-095-20



**BONNEY**  
18,0 cm, 7"  
05-16-120-18



**SINGLE-TUTTLE**  
18,0 cm, 7" 05-16-120-18  
23,0 cm, 9" 05-16-120-23



**DUEHRSEN**  
20,0 cm, 8"  
05-16-470-20



**WAUGH**  
15,0 cm, 6" 05-16-130-15  
18,0 cm, 7" 05-16-130-18  
20,0 cm, 8" 05-16-130-20



**RAMSEY**  
18,0 cm, 7"  
05-16-136-18



Chirurgische Pinzetten  
 Tissue Forceps  
 Pincers a dissection a griffes  
 Pinzas quirúrgicas  
 Пинцеты хирургические



**STANDARD**

10,5 cm, 4 1/8"	<b>05-16-200-10</b>
11,5 cm, 4 1/2"	<b>05-16-200-11</b>
13,0 cm, 5"	<b>05-16-200-13</b>
14,5 cm, 5 3/4"	<b>05-16-200-14</b>
16,0 cm, 6 1/4"	<b>05-16-200-16</b>
18,0 cm, 7"	<b>05-16-200-18</b>
20,0 cm, 8"	<b>05-16-200-20</b>
25,0 cm, 10"	<b>05-16-200-25</b>
30,0 cm, 12"	<b>05-16-200-30</b>

11,5 cm, 4 1/2"	<b>05-16-252-11</b>
13,0 cm, 5"	<b>05-16-252-13</b>
14,5 cm, 5 3/4"	<b>05-16-252-14</b>
16,0 cm, 6 1/4"	<b>05-16-252-16</b>
18,0 cm, 7"	<b>05-16-252-18</b>
20,0 cm, 8"	<b>05-16-252-20</b>
25,0 cm, 10"	<b>05-16-252-25</b>
30,0 cm, 12"	<b>05-16-252-30</b>

13,0 cm, 5"	<b>05-16-254-13</b>
14,5 cm, 5 3/4"	<b>05-16-254-14</b>
16,0 cm, 6 1/4"	<b>05-16-254-16</b>
18,0 cm, 7"	<b>05-16-254-18</b>
20,0 cm, 8"	<b>05-16-254-20</b>

13,0 cm, 5"	<b>05-16-256-13</b>
14,5 cm, 5 3/4"	<b>05-16-256-14</b>
16,0 cm, 6 1/4"	<b>05-16-256-16</b>



1 x 2

fein  
fine  
fin  
finas  
тонкие

11,5 cm, 4½" 05-16-210-11  
13,0 cm, 5" 05-16-210-13  
14,5 cm, 5¾" 05-16-210-14  
16,0 cm, 6¼" 05-16-210-16  
18,0 cm, 7" 05-16-210-18  
20,0 cm, 8" 05-16-210-20



1 x 2

mit Stift  
with pin  
avec goupille  
con perno  
со штифтом

16,0 cm, 6¼"  
05-16-218-16



1 x 2

mit Stift  
with pin  
avec goupille  
con perno  
со штифтом

10,5 cm, 4¼"  
05-16-219-10

Chirurgische Pinzetten  
 Tissue Forceps  
 Pincers a dissection a griffes  
 Pinzas quirúrgicas  
 Пинцеты хирургические

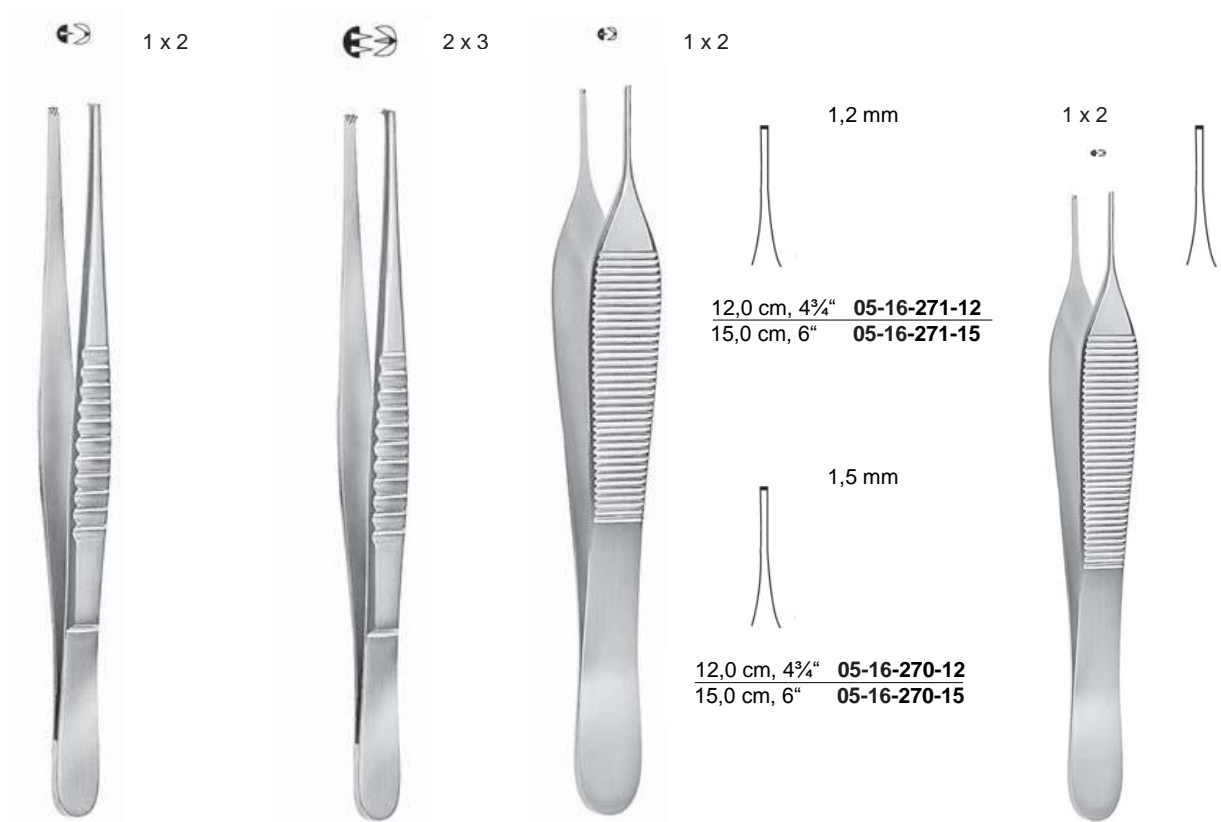

**MOD. USA**

12,0 cm, 4 <sup>3</sup> / <sub>4</sub> "	05-16-206-12
13,0 cm, 5"	05-16-206-13
14,5 cm, 5 <sup>3</sup> / <sub>4</sub> "	05-16-206-14
15,5 cm, 6"	05-16-206-15
18,0 cm, 7"	05-16-206-18
20,0 cm, 8"	05-16-206-20
25,0 cm, 10"	05-16-206-25
30,0 cm, 12"	05-16-206-30

**MOD. USA**

12,0 cm, 4 <sup>3</sup> / <sub>4</sub> "	05-16-212-12
13,0 cm, 5"	05-16-212-13
14,5 cm, 5 <sup>3</sup> / <sub>4</sub> "	05-16-212-14
15,5 cm, 6"	05-16-212-15
18,0 cm, 7"	05-16-212-18
20,0 cm, 8"	05-16-212-20
25,0 cm, 10"	05-16-212-25
30,0 cm, 12"	05-16-212-30

**ADSON**

**MICRO-ADSON**

12,0 cm, 4 <sup>3</sup> / <sub>4</sub> "	05-16-276-12
15,0 cm, 6"	05-16-276-15



Chirurgische Pinzetten  
Tissue Forceps  
Pinces a dissection a griffes  
Pinzas quirúrgicas  
Пинцеты хирургические



**ADSON**  
12,0 cm, 4¾"  
05-16-282-12



**ADSON**  
12,0 cm, 4¾" 05-16-274-12  
15,0 cm, 6" 05-16-274-15



**ADSON-BROWN**  
12,0 cm, 4¾" 05-16-288-12  
15,0 cm, 6" 05-16-288-15



**GILLIES**  
15,0 cm, 6"  
05-16-300-15



**STILLE**  
15,0 cm, 6"  
05-16-208-15



**STILLE**  
15,0 cm, 6"  
05-16-209-15



**ADLERKREUTZ**  
13,0 cm, 5" 05-16-382-13  
15,0 cm, 6" 05-16-382-15  
18,0 cm, 7" 05-16-382-18  
20,0 cm, 8" 05-16-382-20  
25,0 cm, 10" 05-16-382-25



**ADLERKREUTZ**  
13,0 cm, 5" 05-16-384-13  
15,0 cm, 6" 05-16-384-15  
18,0 cm, 7" 05-16-384-18  
20,0 cm, 8" 05-16-384-20  
25,0 cm, 10" 05-16-384-25

Chirurgische Pinzetten  
 Tissue Forceps  
 Pincers a dissection a griffes  
 Pinzas quirúrgicas  
 Пинцеты хирургические

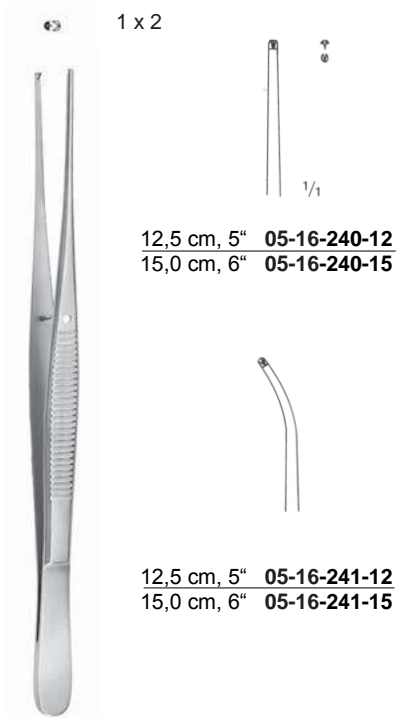

**SEMKEN**



**SEMKEN**  
 12,5 cm, 5"  
 05-16-242-12



**GERALD**  
 18,0 cm, 7"  
 05-16-302-18



**GERALD**  
 18,0 cm, 7"  
 05-16-303-18



**TAYLOR**  
 17,5 cm, 6 7/8"  
 05-16-314-17



**TAYLOR**  
 17,5 cm, 6 7/8"  
 05-16-315-17



**TAYLOR**  
 17,5 cm, 6 7/8"  
 05-16-317-17



**MC INDOE**  
 15,0 cm, 6"  
 05-16-358-15



Chirurgische Pinzetten  
Tissue Forceps  
Pincers a dissection a griffes  
Pinzas quirúrgicas  
Пинцеты хирургические



**CUSHING**  
17,5 cm, 6<sup>5</sup>/<sub>8</sub>"  
05-16-292-17



**CUSHING**  
17,5 cm, 6<sup>5</sup>/<sub>8</sub>"  
05-16-293-17



**POTTS-SMITH**  
18,0 cm, 7" 05-16-226-18  
21,0 cm, 8<sup>1</sup>/<sub>4</sub>" 05-16-226-21  
25,0 cm, 10" 05-16-226-25  
30,0 cm, 12" 05-16-226-30



**POTTS-SMITH**  
18,0 cm, 7" 05-16-227-18  
21,0 cm, 8<sup>1</sup>/<sub>4</sub>" 05-16-227-21  
25,0 cm, 10" 05-16-227-25  
30,0 cm, 12" 05-16-227-30



**WAUGH**  
15,0 cm, 6" 05-16-330-15  
18,0 cm, 7" 05-16-330-18  
20,0 cm, 8" 05-16-330-20  
25,0 cm, 10" 05-16-330-25  
30,5 cm, 12<sup>1</sup>/<sub>2</sub>" 05-16-330-30



**BROPHY**  
20,0 cm, 8"  
05-16-294-20



**BROPHY**  
20,0 cm, 8"  
05-16-295-20



**RUSS. MODELL**  
15,0 cm, 6" 05-16-456-15  
20,0 cm, 8" 05-16-456-20  
25,0 cm, 10" 05-16-456-25  
30,0 cm, 12" 05-16-456-30

Chirurgische Pinzetten  
 Tissue Forceps  
 Pincers a dissection a griffes  
 Pinzas quirúrgicas  
 Пинцеты хирургические



**DURANTE**  
 14,5 cm, 5 3/4" 05-16-460-14  
 16,0 cm, 6 1/4" 05-16-460-16  
 20,0 cm, 8" 05-16-460-20



**DUEHRSEN**  
 20,0 cm, 8"

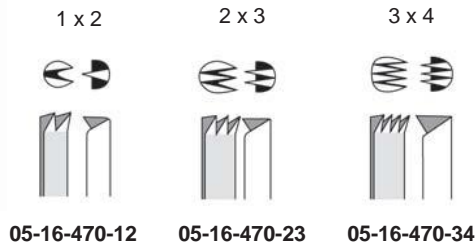

**NELSON**  
 23,0 cm, 9"  
 05-16-518-23



**DUVAL**  
 14,0 cm, 5 1/2"  
 05-16-586-14



**COLLIN-DUVAL**  
 20,0 cm, 8"

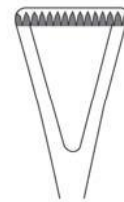

Fig. 1  
 05-16-494-01

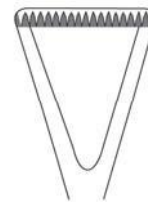

Fig. 2  
 05-16-494-02

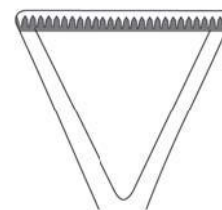

Fig. 3  
 05-16-494-03



Chirurgische Pinzetten  
Tissue Forceps  
Pincers a dissection a griffes  
Pinzas quirúrgicas  
Пинцеты хирургические



1 x 2

**LANE**  
14,5 cm, 5¾" **05-16-420-14**  
18,0 cm, 7" **05-16-420-18**  
20,0 cm, 8" **05-16-420-20**



2 x 3

**LANE**  
14,5 cm, 5¾" **05-16-422-14**  
20,0 cm, 8" **05-16-422-20**



7 x 7

**BROWN**  
12,0 cm, 4¾" **05-16-410-12**  
16,0 cm, 6¾" **05-16-410-16**  
20,0 cm, 8" **05-16-410-20**  
25,0 cm, 10" **05-16-410-25**



1 x 2

**TREVS**  
13,0 cm, 5" **05-16-510-13**  
15,0 cm, 6" **05-16-510-15**  
18,0 cm, 7" **05-16-510-18**



1 x 2

**FERRIS SMITH**  
18,0 cm, 7" **05-16-520-18**



2 x 3

**FERRIS SMITH**  
18,0 cm, 7" **05-16-522-18**



1 x 2

**BONNEY**  
18,0 cm, 7" **05-16-590-18**



2 x 3

**BONNEY**  
18,0 cm, 7" **05-16-592-18**



**Splitterpinzetten**  
**Splinter Forceps**  
**Pinces a écharde**  
**Pinzas para espinas**  
**Пинцеты для извлечения заноз**



8,0 cm, 3¼" **05-16-662-08**  
 9,0 cm, 3½" **05-16-662-09**  
 10,5 cm, 4⅞" **05-16-662-10**  
 11,5 cm, 4½" **05-16-662-11**  
 13,0 cm, 5" **05-16-662-13**  
 14,5 cm, 5½" **05-16-662-14**



8,0 cm, 3¼" **05-16-663-08**  
 9,0 cm, 3½" **05-16-663-09**  
 10,5 cm, 4⅞" **05-16-663-10**  
 11,5 cm, 4½" **05-16-663-11**  
 13,0 cm, 5" **05-16-063-13**  
 14,5 cm, 5½" **05-16-663-14**



8,0 cm, 3¼" **05-16-666-08**  
 9,0 cm, 3½" **05-16-666-09**  
 10,5 cm, 4⅞" **05-16-666-10**  
 11,5 cm, 4½" **05-16-666-11**  
 13,0 cm, 5" **05-16-666-13**  
 14,5 cm, 5½" **05-16-666-14**



8,0 cm, 3¼" **05-16-667-08**  
 9,0 cm, 3½" **05-16-667-09**  
 10,5 cm, 4⅞" **05-16-667-10**  
 11,5 cm, 4½" **05-16-667-11**  
 13,0 cm, 5" **05-16-667-13**  
 14,5 cm, 5½" **05-16-667-14**



Splitterpinzetten, Mikro-Pinzetten  
Splinter Forceps, Micro Forceps  
Pincas a écharde, Princes micro  
Pinzas para espinas, Pinzas para microscopia  
Пинцеты для извлечения заноз, микро-пинцеты



**HUNTER**  
10,5 cm, 4¼"  
05-16-652-10



**HUNTER**  
10,5 cm, 4¼"  
05-16-653-10



**WALTER-CARMALT**  
10,5 cm, 4¼"  
05-16-656-10



**WALTER-CARMALT**  
10,5 cm, 4¼"  
05-16-657-10



**FEILCHENFELD**  
7,5 cm, 3⅜" 05-16-650-07  
9,0 cm, 3½" 05-16-650-09  
11,5 cm, 4½" 05-16-650-11



10,0 cm, 4"  
05-16-806-10



10,0 cm, 4"  
05-16-807-10



05-16-809-16

05-16-810-16

16,0 cm, 6¼"

**Mikro-Pinzetten  
 Micro Forceps  
 Pinces micro  
 Pinzas para microscopia  
 Микро-пинцеты**



**GRAEFE**  
 10,0 cm, 4" **05-16-810-10**  
 13,0 cm, 5" **05-16-810-13**  
 14,0 cm, 5½" **05-16-810-14**



**GRAEFE**  
 10,0 cm, 4" **05-16-811-10**  
 13,0 cm, 5" **05-16-811-13**  
 14,0 cm, 5½" **05-16-811-14**



**GRAEFE**  
 10,0 cm, 4" **05-16-813-10**  
 13,0 cm, 5" **05-16-813-13**  
 14,0 cm, 5½" **05-16-813-14**



**GRAEFE**  
 10,0 cm, 4" **05-16-814-10**  
 13,0 cm, 5" **05-16-814-13**  
 14,0 cm, 5½" **05-16-814-14**



**GRAEFE**  
 10,0 cm, 4" **05-16-815-10**  
 13,0 cm, 5" **05-16-815-13**  
 14,0 cm, 5½" **05-16-815-14**



**GRAEFE**  
 10,0 cm, 4" **05-16-817-10**  
 13,0 cm, 5" **05-16-817-13**  
 14,0 cm, 5½" **05-16-817-14**



Uhrmacher Pinzetten  
Jeweller's Forceps  
Princes d' horloger  
Pinzas de relojeroa  
Пинцеты ювелирные



Fig. 3  
12,0 cm, 4<sup>3</sup>/<sub>4</sub>"  
05-16-601-03



Fig. 4  
11,5 cm, 4<sup>1</sup>/<sub>2</sub>"  
05-16-601-04



Fig. 5  
11,5 cm, 4<sup>1</sup>/<sub>2</sub>"  
05-16-601-05



Fig. 7  
11,5 cm, 4<sup>1</sup>/<sub>2</sub>"  
05-16-601-07



11,0 cm, 4<sup>3</sup>/<sub>8</sub>"  
05-16-620-01



11,0 cm, 4<sup>3</sup>/<sub>8</sub>"  
05-16-620-02



11,0 cm, 4<sup>3</sup>/<sub>8</sub>"  
05-16-620-03



11,0 cm, 4<sup>3</sup>/<sub>8</sub>"  
05-16-620-04



diamantbeschichtet  
diamond coated  
diamant pelliculée  
diamantado  
с алмазным  
покрытием

Atraumatische Pinzetten  
 Atraumatic Forceps  
 Pinces atraumatiques  
 Pinzas atraumáticas  
 Пинцеты атравматические



DE BAKEY

1,5 mm    2,0 mm    2,4 mm    2,8 mm

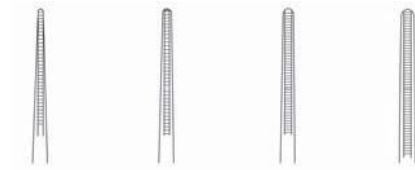

16,0 cm, 6¼"	<b>05-16-700-16</b>	<b>05-16-702-16</b>	<b>05-16-704-16</b>	<b>05-16-706-16</b>
20,0 cm, 8"	<b>05-16-700-20</b>	<b>05-16-702-20</b>	<b>05-16-704-20</b>	<b>05-16-706-20</b>
24,0 cm, 9½"	<b>05-16-700-24</b>	<b>05-16-702-24</b>	<b>05-16-704-24</b>	<b>05-16-706-24</b>
30,0 cm, 12"	<b>05-16-700-30</b>	<b>05-16-702-30</b>	<b>05-16-704-30</b>	<b>05-16-706-30</b>
35,0 cm, 14"	-	<b>05-16-702-35</b>	-	<b>05-16-706-35</b>

3,5 mm



16,0 cm, 6¼"	<b>05-16-708-16</b>
20,0 cm, 8"	<b>05-16-708-20</b>
24,0 cm, 9½"	<b>05-16-708-24</b>
30,0 cm, 12"	<b>05-16-708-30</b>
35,0 cm, 14"	<b>05-16-708-35</b>



DE BAKEY

1,5 mm    2,0 mm



16,0 cm, 6¼"	<b>05-16-701-16</b>	<b>05-16-703-16</b>
20,0 cm, 8"	-	<b>05-16-703-20</b>
24,0 cm, 9½"	-	<b>05-16-703-24</b>
30,0 cm, 12"	-	<b>05-16-703-30</b>



Pinzetten mit Hartmetalleinlagen  
Forceps with tungsten carbide inserts  
Pinces a mors TC  
Pinzas con bocas de carburo tungsteno  
Пинцеты с твердосплавной вставкой

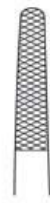

**STANDARD**

13,0 cm, 5" **05-17-200-13**  
14,5 cm, 5<sup>3</sup>/<sub>4</sub>" **05-17-200-14**  
16,0 cm, 6<sup>1</sup>/<sub>4</sub>" **05-17-200-16**  
18,0 cm, 7" **05-17-200-18**  
20,0 cm, 8" **05-17-200-20**  
25,0 cm, 10" **05-17-200-25**

**STANDARD**

14,0 cm, 5<sup>1</sup>/<sub>2</sub>" **05-17-218-14**  
16,0 cm, 6<sup>3</sup>/<sub>4</sub>" **05-17-218-16**  
18,0 cm, 7" **05-17-218-18**  
20,0 cm, 8" **05-17-218-20**

**WANGENSTEIN**

15,0 cm, 6" **05-17-140-15**  
23,0 cm, 9" **05-17-140-23**  
25,0 cm, 10" **05-17-140-25**

Pinzetten mit Hartmetalleinlagen  
 Forceps with tungsten carbide inserts  
 Pinces a mors TC  
 Pinzas con bocas de carburo tungsteno  
 Пинцеты с твердосплавной вставкой

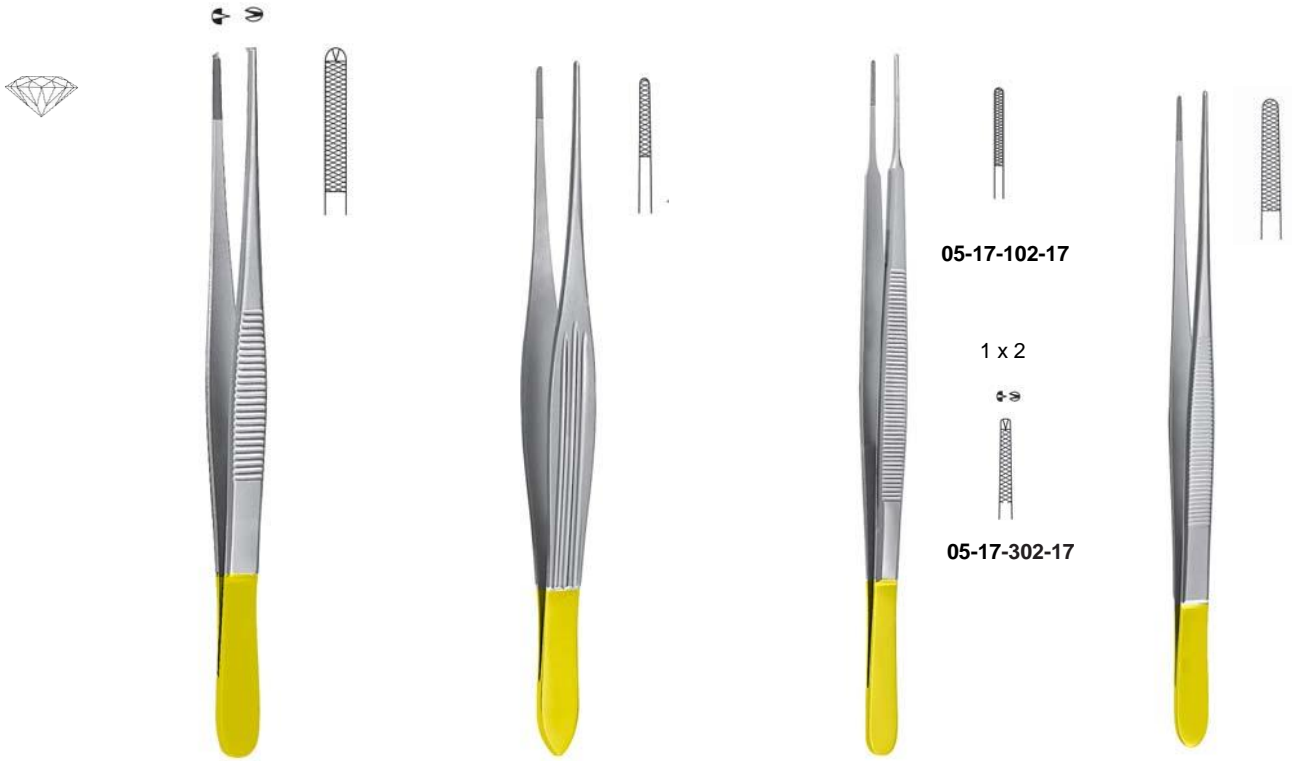

**GILLIES**  
 15,0 cm, 6"  
**05-17-300-15**

**MC INDOE**  
 15,0 cm, 6"  
**05-17-158-15**

**GERALD**  
 18,0 cm, 7"

**05-17-102-17**

1 x 2

**05-17-302-17**

**POTTS-SMITH**  
 15,0 cm, 6" **05-17-026-15**  
 18,0 cm, 7" **05-17-026-18**  
 20,0 cm, 8" **05-17-026-20**  
 25,0 cm, 10" **05-17-026-25**



**BONNEY**  
 17,5 cm, 6<sup>5</sup>/<sub>8</sub>"  
**05-17-590-17**

**CUSHING**  
 17,5 cm, 6<sup>5</sup>/<sub>8</sub>"

**CUSHING-TAYLOR**  
 18,0 cm, 7" **05-17-117-18**  
 20,0 cm, 8" **05-17-117-20**

**ADSON**

12,0 cm, 4<sup>3</sup>/<sub>4</sub>"  
**05-17-070-12**

1 x 2

12,0 cm, 4<sup>3</sup>/<sub>4</sub>"  
**05-17-071-12**

15,0 cm, 6"  
**05-17-070-15**

1 x 2

15,0 cm, 6"  
**05-17-071-15**



Pinzetten mit Hartmetalleinlagen  
Forceps with tungsten carbide inserts  
Pinzas con bocas de carburo tungsteno  
Пинцеты с твердосплавной вставкой



GERALD

Hartmetalleinsätze/  
Tungsten Carbide Insert Jaws/  
Твердосплавные вставки

17,5 cm / 6 3/4" -1,2 mm    **05-1920-18...**  
25 cm / 9 3/4" -1,8 mm    **05-1920-25D**



DeBAKEY-

Hartmetalleinsätze/Tungsten Carbide Insert Jaws/  
Твердосплавные вставки

1,5 x 2,5 mm  
18,2 cm / 7 1/4"    **05-1950-18...**

ATRAUMA

DE BAKEY





**Mikro-Pinzetten  
Micro Forceps  
Princes micro  
Pinzas para microscopia  
Микро-пинцеты**







Mikro-Pinzetten  
Micro Forceps  
Princes micro  
Pinzas para microscopia  
Микро-пинцеты



GERALD



ATRAUMA  
DE BAKEY  
1,2 mm  
18 cm / 7" **05-1191-18**  
20 cm / 8" **05-1195-20**



Maul gerieft/  
Jaws serrated/  
Губки рифленые

	1,0 mm	1,0 mm
18 cm / 7"	<b>05-1196-18</b>	<b>05-1194-18</b>
20 cm / 8"	<b>05-1197-20</b>	<b>05-1196-20</b>
25 cm / 9 3/4"	<b>05-1197-25</b>	<b>05-1196-25</b>



Wolfram-Carbid /  
Wolfram Carbide /  
Карбид вольфрама



Wolfram-Carbid/Wolfram Carbide/Карбид вольфрама

18 cm / 7"  $\varnothing$  1,0 x 0,5 mm **05-1160-18** **05-1165-18**



Glatte  
Maulteile/  
Smooth Jaws/  
Гладкие губки



Wolfram-Carbid/  
Wolfram Carbide/  
Карбид вольфрама

$\varnothing$  1,0 x 0,5 mm

15 cm / 6"	<b>05-1890-15</b>	<b>05-1790-15</b>
18 cm / 7"	<b>05-1890-18</b>	<b>05-1790-18</b>
21 cm / 8"	<b>05-1890-21</b>	<b>05-1790-21</b>



Glatte Maulteile / Smooth Jaws / Гладкие губки

15 cm / 6" - $\varnothing$ 0,4 mm	<b>05-1280-15</b>	<b>05-1285-15</b>	<b>05-1283-15</b>
18 cm / 7" - $\varnothing$ 0,4 mm	<b>05-1280-18</b>	<b>05-1285-18</b>	<b>05-1283-18</b>
15 cm / 6" - $\varnothing$ 0,7 mm	<b>05-1380-15</b>	<b>05-1385-15</b>	<b>05-1383-15</b>
18 cm / 7" - $\varnothing$ 0,7 mm	<b>05-1380-18</b>	<b>05-1385-18</b>	<b>05-1383-18</b>

Wolfram-Carbid / Wolfram Carbide/  
Карбид вольфрама

15 cm / 6" - $\varnothing$ 0,4 mm	<b>05-1480-15</b>	<b>05-1485-15</b>	<b>05-1483-15</b>
18 cm / 7" - $\varnothing$ 0,4 mm	<b>05-1480-18</b>	<b>05-1485-18</b>	<b>05-1483-18</b>
15 cm / 6" - $\varnothing$ 0,7 mm	<b>05-1486-15</b>	<b>05-1487-15</b>	<b>05-1489-15</b>
18 cm / 7" - $\varnothing$ 0,7 mm	<b>05-1486-18</b>	<b>05-1487-18</b>	<b>05-1489-18</b>



Glatte Maulteile/  
Smooth Jaws/  
Гладкие губки



Wolfram-Carbid/  
Wolfram Carbide/  
Карбид вольфрама

15 cm / 6" - $\varnothing$ 1,0 x 0,5 mm	<b>05-1182-15</b>	<b>05-1482-15</b>
18 cm / 7" - $\varnothing$ 1,0 x 0,5 mm	<b>05-1182-18</b>	<b>05-1482-18</b>

15 cm / 6" - $\varnothing$ 0,3 mm	<b>05-1484-15</b>
18 cm / 7" - $\varnothing$ 0,3 mm	<b>05-1484-18</b>

**PIERSE**

15 cm / 6" - $\varnothing$ 0,4 mm	<b>05-1481-15</b>
18 cm / 7" - $\varnothing$ 0,4 mm	<b>05-1481-18</b>

**Mikro-Pinzetten**  
**Micro Forceps**  
**Princes micro**  
**Pinzas para microscopia**  
**Микро-пинцеты**



Glatte Maulteile Smooth Jaws/ Гладкие губки      Wolfram-Carbid/Wolfram Carbide/ Карбид вольфрама

15 cm / 6" - 0,4 x 7,0 mm	<b>05-1880-15</b>	<b>05-1881-15</b>	<b>05-1780-15</b>	<b>05-1781-15</b>
18 cm / 7" - 0,4 x 7,0 mm	<b>05-1880-18</b>	<b>05-1881-18</b>	<b>05-1780-18</b>	<b>05-1781-18</b>
21 cm / 8 1/4" - 0,4 x 7,0 mm	<b>05-1880-21</b>	<b>05-1881-21</b>	<b>05-1780-21</b>	<b>05-1781-21</b>
15 cm / 6" - 0,7 x 7,0 mm	<b>05-1860-15</b>	<b>05-1861-15</b>	<b>05-1760-15</b>	<b>05-1761-15</b>
18 cm / 7" - 0,7 x 7,0 mm	<b>05-1860-18</b>	<b>05-1861-18</b>	<b>05-1760-18</b>	<b>05-1761-18</b>
21 cm / 8 1/4" - 0,7 x 7,0 mm	<b>05-1860-21</b>	<b>05-1861-21</b>	<b>05-1760-21</b>	<b>05-1761-21</b>

1 x 2



15 cm / 6" - Ø 0,4 mm	<b>05-1810-15</b>	<b>05-1811-15</b>
18 cm / 7" - Ø 0,4 mm	<b>05-1810-18</b>	<b>05-1811-18</b>
21 cm / 8 1/4" - Ø 0,4 mm	<b>05-1810-21</b>	<b>05-1811-21</b>
15 cm / 6" - Ø 0,7 mm	<b>05-1812-15</b>	<b>05-1813-15</b>
18 cm / 7" - Ø 0,7 mm	<b>05-1812-18</b>	<b>05-1813-18</b>
21 cm / 8 1/4" - Ø 0,7 mm	<b>05-1812-21</b>	<b>05-1813-21</b>

ATRAUMA  
  
 DE BAKEY

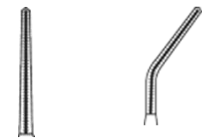

15 cm / 6" - 1,2 mm	<b>05-1800-15</b>	<b>05-1803-15</b>
18 cm / 7" - 1,2 mm	<b>05-1800-18</b>	<b>05-1803-18</b>
21 cm / 8 1/4" - 1,2 mm	<b>05-1800-21</b>	<b>05-1803-21</b>



mit Fadenplatte / with tying platform / для завязывания нитей  
 Glatte Maulteile/Smooth Jaws/ Гладкие губки      Wolfram-Carbid/Wolfram Carbide/ Карбид вольфрама

15 cm / 6" - 0,4 x 7,0 mm	<b>05-1170-15</b>	<b>05-1175-15</b>	<b>05-1580-15</b>	<b>05-1585-15</b>
18 cm / 7" - 0,4 x 7,0 mm	<b>05-1170-18</b>	<b>05-1175-18</b>	<b>05-1580-18</b>	<b>05-1585-18</b>
21 cm / 8 1/4" - 0,4 x 7,0 mm	<b>05-1170-21</b>	<b>05-1175-21</b>	<b>05-1580-21</b>	<b>05-1585-21</b>
23 cm / 9" - 0,4 x 7,0 mm	<b>05-1170-23</b>	<b>05-1175-23</b>	<b>05-1580-23</b>	<b>05-1585-23</b>
15 cm / 6" - 0,7 x 7,0 mm	<b>05-1171-15</b>	<b>05-1176-15</b>	<b>05-1581-15</b>	<b>05-1586-15</b>
18 cm / 7" - 0,7 x 7,0 mm	<b>05-1171-18</b>	<b>05-1176-18</b>	<b>05-1581-18</b>	<b>05-1586-18</b>
21 cm / 8 1/4" - 0,7 x 7,0 mm	<b>05-1171-21</b>	<b>05-1176-21</b>	<b>05-1581-21</b>	<b>05-1586-21</b>
23 cm / 9" - 0,7 x 7,0 mm	<b>05-1171-23</b>	<b>05-1176-23</b>	<b>05-1581-23</b>	<b>05-1586-23</b>

1 x 2

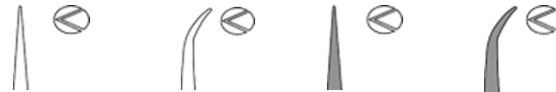

Glatte Maulteile/Smooth Jaws/ Гладкие губки      Wolfram-Carbid/Wolfram Carbide/ Карбид вольфрама

15 cm / 6" - Ø 0,4 mm	<b>05-1290-15</b>	<b>05-1295-15</b>	<b>05-1590-15</b>	<b>05-1595-15</b>
18 cm / 7" - Ø 0,4 mm	<b>05-1290-18</b>	<b>05-1295-18</b>	<b>05-1590-18</b>	<b>05-1595-18</b>
21 cm / 8 1/4" - Ø 0,4 mm	<b>05-1290-21</b>	<b>05-1295-21</b>	<b>05-1590-21</b>	<b>05-1595-21</b>

ATRAUMA  
  
 DE BAKEY



DeBAKEY

15 cm / 6" - 1,2 mm	<b>05-1190-15</b>	<b>05-1195-15</b>
18 cm / 7" - 1,2 mm	<b>05-1190-18</b>	<b>05-1195-18</b>
21 cm / 8 1/4" - 1,2 mm	<b>05-1190-21</b>	<b>05-1195-21</b>



Mikro-Pinzetten  
Micro Forceps  
Pinces micro  
Pinzas para microscopia  
Микро-пинцеты



1 x 2



Glatte Maulteile/Smooth Jaws/  
Гладкие губки      Wolfram-Carbid/Wolfram Carbide/  
Карбид вольфрама

15 cm / 6" - Ø 0,7 mm	<b>05-1291-15</b>	<b>05-1296-15</b>	<b>05-1591-15</b>	<b>05-1596-15</b>
18 cm / 7" - Ø 0,7 mm	<b>05-1291-18</b>	<b>05-1296-18</b>	<b>05-1591-18</b>	<b>05-1596-18</b>
21 cm / 8 1/4" - Ø 0,7 mm	<b>05-1291-21</b>	<b>05-1296-21</b>	<b>05-1591-21</b>	<b>05-1596-21</b>



Glatte Maulteile/Smooth Jaws/  
Гладкие губки      Wolfram-Carbid/Wolfram Carbide/  
Карбид вольфрама

15 cm / 6" - 1,0 x 0,5 mm	<b>05-1180-15</b>	<b>05-1185-15</b>	<b>05-1660-15</b>	<b>05-1665-15</b>
18 cm / 7" - 1,0 x 0,5 mm	<b>05-1180-18</b>	<b>05-1185-18</b>	<b>05-1660-18</b>	<b>05-1665-18</b>
21 cm / 8 1/4" - 1,0 x 0,5 mm	<b>05-1180-21</b>	<b>05-1185-21</b>	<b>05-1660-21</b>	<b>05-1665-21</b>
23 cm / 9" - 1,0 x 0,5 mm	<b>05-1180-23</b>	<b>05-1185-23</b>	<b>05-1660-23</b>	<b>05-1665-23</b>
15 cm / 6" - 2,0 x 0,8 mm	<b>05-1181-15</b>	<b>05-1186-15</b>	<b>05-1661-15</b>	<b>05-1666-15</b>
18 cm / 7" - 2,0 x 0,8 mm	<b>05-1181-18</b>	<b>05-1186-18</b>	<b>05-1661-18</b>	<b>05-1666-18</b>
21 cm / 8 1/4" - 2,0 x 0,8 mm	<b>05-1181-21</b>	<b>05-1186-21</b>	<b>05-1661-21</b>	<b>05-1666-21</b>



mit Fadenplatte / with tying platform / для завязывания нитей  
Glatte Maulteile/Smooth Jaws/  
Гладкие губки      Wolfram-Carbid/Wolfram Carbide/  
Карбид вольфрама

15 cm / 6" - 0,4 x 7,0 mm	<b>05-1882-15</b>	<b>05-1883-15</b>	<b>05-1782-15</b>	<b>05-1783-15</b>
18 cm / 7" - 0,4 x 7,0 mm	<b>05-1882-18</b>	<b>05-1883-18</b>	<b>05-1782-18</b>	<b>05-1783-18</b>
21 cm / 8 1/4" - 0,4 x 7,0 mm	<b>05-1882-21</b>	<b>05-1883-21</b>	<b>05-1782-21</b>	<b>05-1783-21</b>
23 cm / 9" - 0,4 x 7,0 mm	<b>05-1882-23</b>	<b>05-1883-23</b>	<b>05-1782-23</b>	<b>05-1783-23</b>
25 cm / 9 3/4" - 0,4 x 7,0 mm	<b>05-1882-25</b>	<b>05-1883-25</b>	<b>05-1782-25</b>	<b>05-1782-25</b>
15 cm / 6" - 0,7 x 7,0 mm	<b>05-1887-15</b>	<b>05-1899-15</b>	<b>05-1787-25</b>	<b>05-1799-15</b>
18 cm / 7" - 0,7 x 7,0 mm	<b>05-1887-18</b>	<b>05-1899-18</b>	<b>05-1787-18</b>	<b>05-1799-18</b>
21 cm / 8 1/4" - 0,7 x 7,0 mm	<b>05-1887-21</b>	<b>05-1899-21</b>	<b>05-1787-21</b>	<b>05-1799-21</b>
23 cm / 9" - 0,7 x 7,0 mm	<b>05-1887-23</b>	<b>05-1899-23</b>	<b>05-1787-23</b>	<b>05-1799-23</b>
25 cm / 9 3/4" - 0,7 x 7,0 mm	<b>05-1887-25</b>	<b>05-1899-25</b>	<b>05-1787-25</b>	<b>05-1799-25</b>

ATRAUMA  
DE BAKEY



15 cm / 6" - 1,2 mm	<b>05-1808-15</b>	<b>05-1809-15</b>	Wolfram-Carbid/Wolfram Carbide/ Карбид вольфрама	
18 cm / 7" - 1,2 mm	<b>05-1808-18</b>	<b>05-1809-18</b>	18 cm / 7" - 1,0 x 0,5 mm	<b>05-1714-18</b>
21 cm / 8 1/4" - 1,2 mm	<b>05-1808-21</b>	<b>05-1809-21T</b>	21 cm / 8 1/4" - 1,0 x 0,5 mm	<b>05-1714-21</b>

Mikro-Pinzetten  
 Micro Forceps  
 Princes micro  
 Pinzas para microscopia  
 Микро-пинцеты



Glatte Maulteile/Smooth Jaws/  
 Гладкие губки      Wolfram-Carbid/Wolfram Carbide/  
 Карбид вольфрама

15 cm / 6"- 1,0 x 0,5 mm	<b>05-1892-15</b>	<b>05-1893-15</b>	<b>05-1792-15</b>	<b>05-1793-15</b>
18 cm / 7"- 1,0 x 0,5 mm	<b>05-1892-18</b>	<b>05-1893-18</b>	<b>05-1792-18</b>	<b>05-1793-18</b>
21 cm / 8 1/4"- 1,0 x 0,5 mm	<b>05-1892-21</b>	<b>05-1893-21</b>	<b>05-1792-21</b>	<b>05-1793-21</b>
23 cm / 9"- 1,0 x 0,5 mm	<b>05-1892-23</b>	<b>05-1893-23</b>	<b>05-1792-23</b>	<b>05-1793-23</b>
25 cm / 9 3/4"- 1,0 x 0,5 mm	<b>05-1892-25</b>	<b>05-1893-25</b>	<b>05-1792-25</b>	<b>05-1793-25</b>
18 cm / 7"- 2,0 x 0,8 mm			<b>05-1791-18</b>	<b>05-1795-18</b>

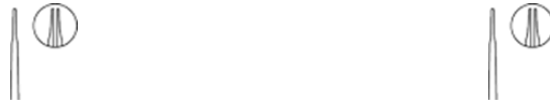

Arbeitsenteil eingesetzt/with inserted jaws/  
 с вставными губками

**PIERSE**

15 cm / 6"- Ø 0,3 mm	<b>05-1784-15</b>	15 cm / 6"- Ø 0,4 mm	<b>05-1786-15</b>
18 cm / 7"- Ø 0,3 mm	<b>05-1784-18</b>	18 cm / 7"- Ø 0,4 mm	<b>05-1786-18</b>



Glatte Maulteile/Smooth Jaws/  
 Гладкие губки      Wolfram-Carbid/Wolfram Carbide/  
 Карбид вольфрама

18 cm / 7"- 0,4 x 7,0 mm	<b>05-1683-18</b>	<b>05-1685-18</b>	<b>05-1703-18</b>	<b>05-1705-18</b>
21 cm / 8 1/4"- 0,4 x 7,0 mm	<b>05-1683-21</b>	<b>05-1685-21</b>	<b>05-1703-21</b>	<b>05-1705-21</b>
23 cm / 9"- 0,4 x 7,0 mm	<b>05-1683-23</b>	<b>05-1685-23</b>	<b>05-1703-23</b>	<b>05-1705-23</b>
18 cm / 7"- 0,7 x 7,0 mm	<b>05-1680-18</b>	<b>05-1681-18</b>	<b>05-1700-18</b>	<b>05-1701-18</b>
21 cm / 8 1/4"- 0,7 x 7,0 mm	<b>05-1680-21</b>	<b>05-1681-21</b>	<b>05-1700-21</b>	<b>05-1701-21</b>
23 cm / 9"- 0,7 x 7,0 mm	<b>05-1680-23</b>	<b>05-1681-23</b>	<b>05-1700-23</b>	<b>05-1701-23</b>



Glatte Maulteile/Smooth Jaws/  
 Гладкие губки      Wolfram-Carbid/Wolfram Carbide/  
 Карбид вольфрама

18 cm / 7"- Ø 1,0 x 0,5 mm	<b>05-1690-18</b>	<b>05-1710-18</b>
21 cm / 8 1/4"- Ø 1,0 x 0,5 mm	<b>05-1690-21</b>	<b>05-1710-21</b>
23 cm / 9"- Ø 1,0 x 0,5 mm	<b>05-1690-23</b>	<b>05-1710-23</b>



Mikro-Pinzetten  
Micro Forceps  
Pinces micro  
Pinzas para microscopia  
Микро-пинцеты



TOLEDO

ATRAUMA  
DE BAKEY

18 cm / 7"- 1,2 mm  
21 cm / 8 1/4"- 1,2 mm



05-1800-18T 05-1803-18T  
05-1800-21T 05-1803-21T

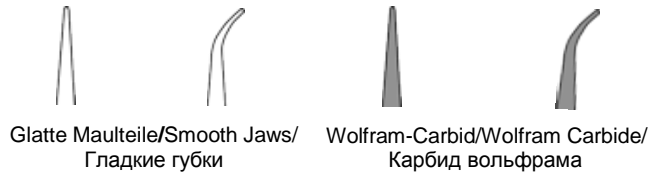

Glatte Maulteile/Smooth Jaws/  
Гладкие губки Wolfram-Carbid/Wolfram Carbide/  
Карбид вольфрама

18 cm / 7"- 0,4 x 7,0 mm	05-1880-18T	05-1881-18T	05-1780-18T	05-1781-18T
21 cm / 8 1/4"- 0,4 x 7,0 mm	05-1880-21T	05-1881-21T	05-1780-21T	05-1781-21T
18 cm / 7"- 0,7 x 7,0 mm	05-1860-18T	05-1861-18T	05-1760-18T	05-1761-18T
21 cm / 8 1/4"- 0,7 x 7,0 mm	05-1860-21T	05-1861-21T	05-1760-21T	05-1761-21T

1 x 2 teeth

18 cm / 7"- Ø 0,4 mm	05-1810-18T	05-1811-18T	05-1812-18T	05-1813-18T
21 cm / 8 1/4"- Ø 0,4 mm	05-1810-21T	05-1811-21T	05-1812-21T	05-1813-21T



Glatte Maulteile/  
Smooth Jaws/  
Гладкие губки Wolfram-Carbid/  
Wolfram Carbide/  
Карбид вольфрама

18 cm / 7"- Ø 1,0 x 0,5 mm	05-1890-18T	05-1790-18T
21 cm / 8 1/4"- Ø 1,0 x 0,5 mm	05-1890-21T	05-1790-21T



TOLEDO

ATRAUMA  
DE BAKEY

18 cm / 7"- 1,2 mm	05-1190-18T	05-1195-18T
21 cm / 8 1/4"- 1,2 mm	05-1190-21T	05-1195-21T

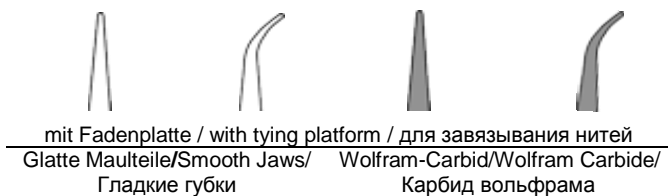

mit Fadenplatte / with tying platform / для завязывания нитей  
Glatte Maulteile/Smooth Jaws/  
Гладкие губки Wolfram-Carbid/Wolfram Carbide/  
Карбид вольфрама

15 cm / 6"- 0,4 x 7,0 mm	05-1170-15T	05-1175-15T	05-1580-15T	05-1585-15T
18 cm / 7"- 0,4 x 7,0 mm	05-1170-18T	05-1175-18T	05-1580-18T	05-1585-18T
21 cm / 8 1/4"- 0,4 x 7,0 mm	05-1170-21T	05-1175-21T	05-1580-21T	05-1585-21T
15 cm / 6"- 0,7 x 7,0 mm	05-1171-15T	05-1176-15T	05-1581-15T	05-1586-15T
18 cm / 7"- 0,7 x 7,0 mm	05-1171-18T	05-1176-18T	05-1581-18T	05-1586-18T
21 cm / 8 1/4"- 0,7 x 7,0 mm	05-1171-21T	05-1176-21T	05-1581-21T	05-1586-21T

1 x 2

18 cm / 7"- Ø 0,4 mm	05-1140-18T	05-1145-18T	05-1142-18T	05-1147-18T
21 cm / 8 1/4"- Ø 0,4 mm	05-1140-21T	05-1145-21T	05-1142-21T	05-1147-21T

Mikro-Pinzetten  
 Micro Forceps  
 Princes micro  
 Pinzas para microscopia  
 Микро-пинцеты



TOLEDO



Glatte Maulteile/Smooth Jaws/  
 Гладкие губки      Wolfram-Carbid/Wolfram Carbide/  
 Карбид вольфрама

15 cm / 6"- 1,0 x 0,5 mm	<b>05-1180-15T</b>	<b>05-1185-15T</b>	<b>05-1660-15T</b>	<b>05-1665-15T</b>
18 cm / 7"- 1,0 x 0,5 mm	<b>05-1180-18T</b>	<b>05-1185-18T</b>	<b>05-1660-18T</b>	<b>05-1665-18T</b>
21 cm / 8 1/4"- 1,0 x 0,5 mm	<b>05-1180-21T</b>	<b>05-1185-21T</b>	<b>05-1660-21T</b>	<b>05-1665-21T</b>



TOLEDO



mit Fadenplatte / with tying platform / для завязывания нитей  
 Glatte Maulteile/Smooth Jaws/  
 Гладкие губки      Wolfram-Carbid/Wolfram Carbide/  
 Карбид вольфрама

18 cm / 7"- 0,4 x 7,0 mm	<b>05-1882-18T</b>	<b>05-1883-18T</b>	<b>05-1782-18T</b>	<b>05-1783-18T</b>
21 cm / 8 1/4"- 0,4 x 7,0 mm	<b>05-1882-21T</b>	<b>05-1883-21T</b>	<b>05-1782-21T</b>	<b>05-1783-21T</b>
18 cm / 7"- 0,7 x 7,0 mm	<b>05-1887-18T</b>	<b>05-1899-18T</b>	<b>05-1787-18T</b>	<b>05-1799-18T</b>
21 cm / 8 1/4"- 0,7 x 7,0 mm	<b>05-1887-21T</b>	<b>05-1899-21T</b>	<b>05-1787-21T</b>	<b>05-1799-21T</b>



Glatte Maulteile/Smooth Jaws/  
 Гладкие губки      Wolfram-Carbid/Wolfram Carbide/  
 Карбид вольфрама

18 cm / 7"- 1,0 x 0,5 mm	<b>05-1892-18T</b>	<b>05-1893-18T</b>	<b>05-1792-18T</b>	<b>05-1793-18T</b>
21 cm / 8 1/4"- 1,0 x 0,5 mm	<b>05-1892-21T</b>	<b>05-1893-21T</b>	<b>05-1792-21T</b>	<b>05-1793-21T</b>



18 cm / 7"- 1,2 mm	<b>05-1808-18T</b>	<b>05-1809-18T</b>
21 cm / 8 1/4"- 1,2 mm	<b>05-1808-21T</b>	<b>05-1809-21T</b>





Titan Forceps

mit Fadenplatte / with tying platform / для завязывания нитей  
Glatte Maulteile/Smooth Jaws/ Гладкие губки      Wolfram-Carbid/Wolfram Carbide/ Карбид вольфрама

18 cm / 7" - 0,4 x 7,0 mm	05-11171-18	05-11176-18	05-11581-18	05-11586-18
21 cm / 8 1/4" - 0,4 x 7,0 mm	05-11171-21	05-11176-21	05-11581-21	05-11586-21
18 cm / 7" - 0,7 x 7,0 mm	05-11170-18	05-11175-18	05-11580-18	05-11585-18
21 cm / 8 1/4" - 0,7 x 7,0 mm	05-11170-21	05-11175-21	05-11580-21	05-11585-21

Glatte Maulteile/Smooth Jaws/ Гладкие губки      Wolfram-Carbid/Wolfram Carbide/ Карбид вольфрама

18 cm / 7" - 1,0 x 0,5 mm	05-11180-18	05-11185-18	05-11660-18	05-11665-18
21 cm / 8 1/4" - 1,0 x 0,5 mm	05-11180-21	05-11185-21	05-11660-21	05-11665-21

ATRAUMA  
DE BAKEY

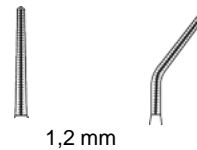

18 cm / 7"	05-11190-18	05-11195-18
21 cm / 8 1/4"	05-11190-21	05-11195-21



YASARGIL  
23 cm / 9"

Maul löffelförmig, glatt/Spoon-shaped, smooth jaws/  
Гладкие ложкообразные губки



aufgebogen/curved up/изогнутые вперед  
05-1150-23      05-1151-23      05-1152-23

Maul löffelförmig, glatt/Spoon-shaped, smooth jaws/  
Гладкие ложкообразные губки



Zurückgebogenen/curved down/изогнутые назад  
05-1153-23      05-1154-23      05-1155-23



YASARGIL  
22 cm / 8 3/4"

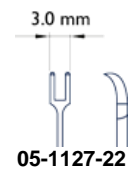

05-1127-22

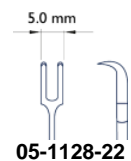

05-1128-22

**Tumorfaß Pinzetten**  
**Tumor Grasping Forceps**  
**Tumor Pinces**  
**Tumor Pinzas**  
**Тумор пинцеты**



**YASARGIL**

Maul löffelförmig mit 14 Zähnen/Spoon-shaped, jaws with 14 teeth/  
 Ложкообразные губки с 14 зубцами  
 grob gezahnt/heavily serrated/грубо зазубренные

	Ø 3,0 mm	Ø 5,0 mm
16 cm / 6 1/2"	<b>05-1120-16</b>	<b>05-1123-16</b>
20 cm / 8"	<b>05-1120-20</b>	<b>05-1123-20</b>
22 cm / 8 3/4"	<b>05-1120-22</b>	<b>05-1123-22</b>

Maul löffelförmig mit 16 Zähnen/Spoon-shaped, jaws with 16 teeth/  
 Ложкообразные губки с 16 зубцами  
 fein gezahnt/fine serrated/тонко зазубренные

	Ø 3,0 mm	Ø 5,0 mm
16 cm / 6 1/2"	<b>05-1121-16</b>	<b>05-1124-16</b>
20 cm / 8"	<b>05-1121-20</b>	<b>05-1124-20</b>
22 cm / 8 3/4"	<b>05-1121-22</b>	<b>05-1124-22</b>

Maul löffelförmig, glatt/Spoon-shaped, smooth jaws/  
 Гладкие ложкаобразные губки

	Ø 3,0 mm	Ø 5,0 mm
22 cm / 8 3/4"	<b>05-1122-22</b>	<b>05-1125-22</b>
24 cm / 9 1/2"	<b>05-1122-24</b>	<b>05-1125-24</b>

Maul löffelförmig mit 16 Zähnen/  
 Spoon-shaped, jaws with 16 teeth/  
 Ложкообразные губки с 16 зубцами  
 22 cm / 8 3/4" Ø 3,0 mm



fein gezahnt gewinkelt/delicate  
 serrated angled/  
 тонко зазубренные

**05-1126-22**



**YASARGIL**

	Glatte Maulteile/Smooth Jaws/ Гладкие губки		Wolfram-Carbid/Wolfram Carbide/ Карбид вольфрама	
	0,6 mm	0,9 mm	0,6 mm	0,9 mm
16 cm / 6 1/2"	<b>05-1130-16</b>	<b>05-1131-16</b>	<b>05-1134-16</b>	<b>05-1135-16</b>
18 cm / 7"	<b>05-1130-18</b>	<b>05-1131-18</b>	<b>05-1134-18</b>	<b>05-1135-18</b>
20 cm / 8"	<b>05-1130-20</b>	<b>05-1131-20</b>	<b>05-1134-20</b>	<b>05-1135-20</b>
22 cm / 8 3/4"	<b>05-1130-22</b>	<b>05-1131-22</b>	<b>05-1134-22</b>	<b>05-1135-22</b>
24 cm / 9 1/2"	<b>05-1130-24</b>	<b>05-1131-24</b>	<b>05-1134-24</b>	<b>05-1135-24</b>

	Glatte Maulteile mit Führungsstift/ Smooth Jaws with guide pin/ Гладкие губки с направляющим штифтом		Wolfram-Carbid/Wolfram Carbide/ Карбид вольфрама	
	0,6 mm	0,9 mm	0,6 mm	0,9 mm
23 cm / 9"	<b>05-1132-23</b>	<b>05-1133-23</b>	<b>05-1136-23</b>	<b>05-1136-23</b>

1 x 2  
 18 cm / 7  
 1,2 mm  
**05-1138-18**

Mikro-Pinzetten  
Micro Forceps  
Princes micro  
Pinzas para microscopia  
Микро-пинцеты



**UTILITY**  
10 cm / 4"

Anatomische/anatomic/анатомические

0,5 mm	<b>05-1450-10</b>
0,7 mm	<b>05-1452-10</b>
1,0 mm	<b>05-1454-10</b>
1,2 mm	<b>05-1456-10</b>
1,4 mm	<b>05-1458-10</b>

mit Zähnen/with teeth/с зубами

0,5 mm	<b>05-1460-10</b>
0,7 mm	<b>05-1462-10</b>
1,0 mm	<b>05-1464-10</b>
1,2 mm	<b>05-1466-10</b>
1,4 mm	<b>05-1468-10</b>



**COLIBRI**  
8 cm / 3 1/4"

Standard/Standard/  
Стандарт



**05-1221-08**

extra fein/  
extra delicate/  
экстра тонкие



**05-1223-08**



**BONN**  
7,5 cm / 3"  
**05-1420-08**



**BONN**  
8 cm / 3 1/4"

1 x 2 mit Zähnen/with teeth/с зубами

gerade/straight/  
прямой

6,0 mm



**05-1320-08**

abgewinkelt/angled/  
изогнутые под углом

6,0 mm



**05-1325-08**

abgewinkelt/angled/  
изогнутые под углом

8,0 mm



**05-1327-08**

**BARSEWISCH**  
Vorderkammer-Pinzette  
abgewinkelt/Arterior Chamber  
Forceps angled/Arterior  
Chamber/угловой пинцет



**05-1345-08**

Anatomische/anatomic/анатомические

gerade/straight/  
прямой

6,0 mm



**05-1330-08**

abgewinkelt/angled/  
изогнутые под углом

6,0 mm



**05-1335-08**

abgewinkelt/angled/  
изогнутые под углом

8,0 mm



**05-1337-08**



**TÜBINGEN**

23 cm / 9"



**05-1400-11**



**05-1405-11**

extra fein/  
extra delicate/  
экстра тонкие



**05-1410-09**

8,5 cm / 3 1/3"



**McDONALS-SPALECK**  
10 cm / 4"

5 mm  
**05-1200-10**

6 mm  
**05-1202-10**



**FAULKNER**  
10 cm / 4"

5 mm  
**05-1310-05**  
6 mm  
**05-1310-06**  
11 mm  
**05-1310-11**

**Tuch-, Schlauchklemmen, Tupferzangen  
Towel Clamps, Sponge and Dressing Forceps,  
Tubing Clamps  
Pinces a pansement et a éponges, Pinces a  
champs, pincés presse-tubes  
Pinzas de campo, Pinzas para vendajes  
y torundas y para tubos  
Зажимы для операционного белья,  
для тампонов, для трубок**







Tuchklemmen  
Towel Clamps  
Pinces a champs  
Pinzas de campo  
Зажимы для операционного белья



**SCHAEDEL**  
9,0 cm, 3½"  
07-22-101-09



**ENGL. MODELL**  
9,0 cm, 3½"  
07-22-109-09



**JONES**  
5,5 cm, 2" 07-22-105-05  
9,0 cm, 3½" 07-22-105-09



**JONES**  
9,0 cm, 3½"  
07-22-107-09

mit Schlauch- oder Kabelhalter  
with clip for tubing or cable  
avec clamp porte-tube  
con porta-tubo o porta-cable  
с зажимом для кабеля и трубки

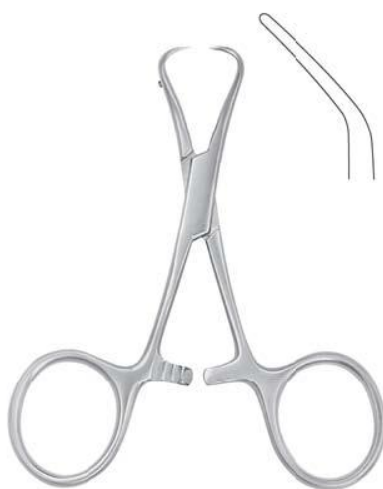

**BACKHAUS**  
9,0 cm, 3½" 07-22-000-09  
11,0 cm, 4¾" 07-22-000-11  
13,0 cm, 5" 07-22-000-13  
15,0 cm, 6" 07-22-000-15



**ROEDER**  
11,0 cm, 4¾" 07-22-005-11  
13,0 cm, 5" 07-22-005-13  
15,0 cm, 6" 07-22-005-15



**ROEDER**  
13,0 cm, 5" 07-22-010-13  
15,0 cm, 6" 07-22-010-15

Tuchklemmen  
Towel Clamps  
Pinces a champs  
Pinzas de campo  
Зажимы для операционного белья



**BERNHARD**  
16,5 cm, 6½"  
07-22-044-16



9,5 cm, 4" 07-22-024-10  
11,0 cm, 4¾" 07-22-024-11  
13,0 cm, 5" 07-22-024-13  
14,0 cm, 5½" 07-22-024-14  
15,5 cm, 6¼" 07-22-024-16



**LORNA**  
9,0 cm, 3½" 07-22-014-09  
11,0 cm, 4¾" 07-22-014-11  
13,0 cm, 5" 07-22-014-13



**LANE**  
13,0 cm, 5" 07-22-040-13  
15,0 cm, 6" 07-22-040-15  
20,0 cm, 8" 07-22-040-20



Tuchklemmen, Korn- und Tupferzangen  
 Towel Clamps, Sponge and Dressing Forceps  
 Pinces a champs, Pinces a pansement et a éponges  
 Pinzas de campo, Pinzas para vendajes y torundas  
 Зажимы для операционного белья, зажимы для тампона



**TOHOKU**

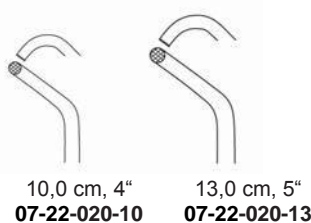

**PEERS**  
 14,5 cm, 5¾"  
 07-22-030-14



**LISTER**  
 13,0 cm, 5" 07-22-360-13  
 16,0 cm, 6¼" 07-22-360-16  
 18,0 cm, 7" 07-22-360-18



**BRYANT**  
 13,0 cm, 5"  
 07-22-351-13



**BOZEMANN**  
 26,0 cm, 10¼"  
 07-22-320-26



**Korn- und Tupferzangen**  
**Sponge and Dressing Forceps**  
**Pinces a pansement et a éponges**  
**Pinzas para vendajes y torundas**  
**Зажимы для тампона**



**BOZEMANN**  
 26,0 cm, 10¼"  
 07-22-321-26



**COLLIN**  
 25,0 cm, 9¾"  
 07-22-300-25



**CHERON**  
 25,0 cm, 9¾"  
 07-22-303-25

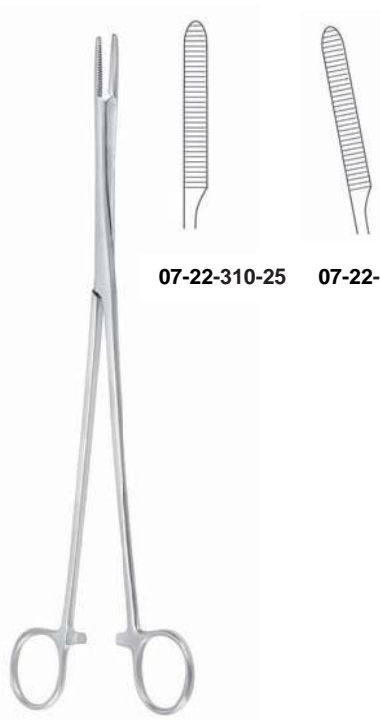

**PERLMANN**  
 25,0 cm, 9¾"

07-22-310-25    07-22-311-25



**ULRICH**

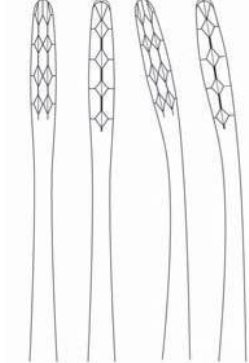

18,0 cm, 7"	<b>07-22-200-18</b>	<b>07-22-201-18</b>
22,0 cm, 8⅝"	<b>07-22-200-22</b>	<b>07-22-201-22</b>
26,0 cm, 10¼"	<b>07-22-200-26</b>	<b>07-22-201-26</b>

Korn- und Tupferzangen  
Sponge and Dressing Forceps  
Pinces a pansement et a éponges  
Pinzas para vendajes y torundas  
Зажимы для тампона

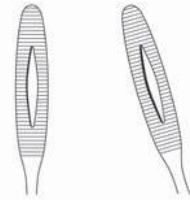

mit Sperre, with ratchet, avec crémaillère,  
con cremallera, с кремальерой

18,0 cm, 7"	07-22-210-18	07-22-211-18
20,0 cm, 8"	07-22-210-20	07-22-211-20
22,0 cm, 8¾"	07-22-210-22	07-22-211-22
27,0 cm, 10¾"	07-22-210-27	07-22-211-27

ohne Sperre, without ratchet, sans crémaillère,  
sin cremallera, без кремальеры

18,0 cm, 7"	07-22-212-18	07-22-213-18
20,0 cm, 8"	07-22-212-20	07-22-213-20
25,0 cm, 9¾"	07-22-212-25	07-22-213-25

GROSS-MAIER



25,0 cm, 9¾"  
07-22-180-25

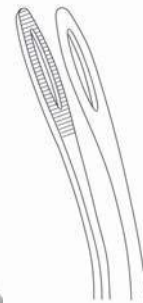

25,0 cm, 9¾"  
07-22-181-25

FOERSTER

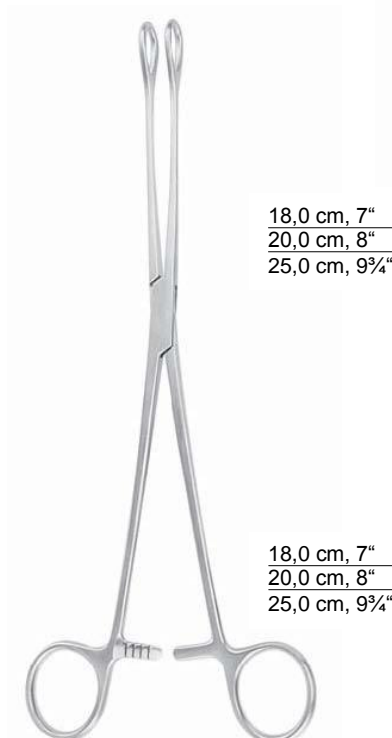

18,0 cm, 7"	07-22-160-18	07-22-161-18
20,0 cm, 8"	07-22-160-20	07-22-161-20
25,0 cm, 9¾"	07-22-160-25	07-22-161-25



18,0 cm, 7"	07-22-170-18	07-22-171-18
20,0 cm, 8"	07-22-170-20	07-22-171-20
25,0 cm, 9¾"	07-22-170-25	07-22-171-25

FOERSTER-BALLENGIER



RAMPLEY

18,0 cm, 7"	07-22-190-18
25,0 cm, 9¾"	07-22-190-25

Schlauchklemmen  
 Tubing Clamps  
 Pincés presse-tubes  
 Pinzas para tubos  
 Зажимы для трубок



**PRESBYTERIAN**  
 16,0 cm, 6 $\frac{3}{4}$ " 07-23-012-16  
 18,0 cm, 7" 07-23-012-18  
 20,0 cm, 8" 07-23-012-20  
 22,0 cm, 8 $\frac{3}{4}$ " 07-23-012-22



**BERLIN**  
 14,5 cm, 5 $\frac{3}{4}$ "  
 07-23-006-14

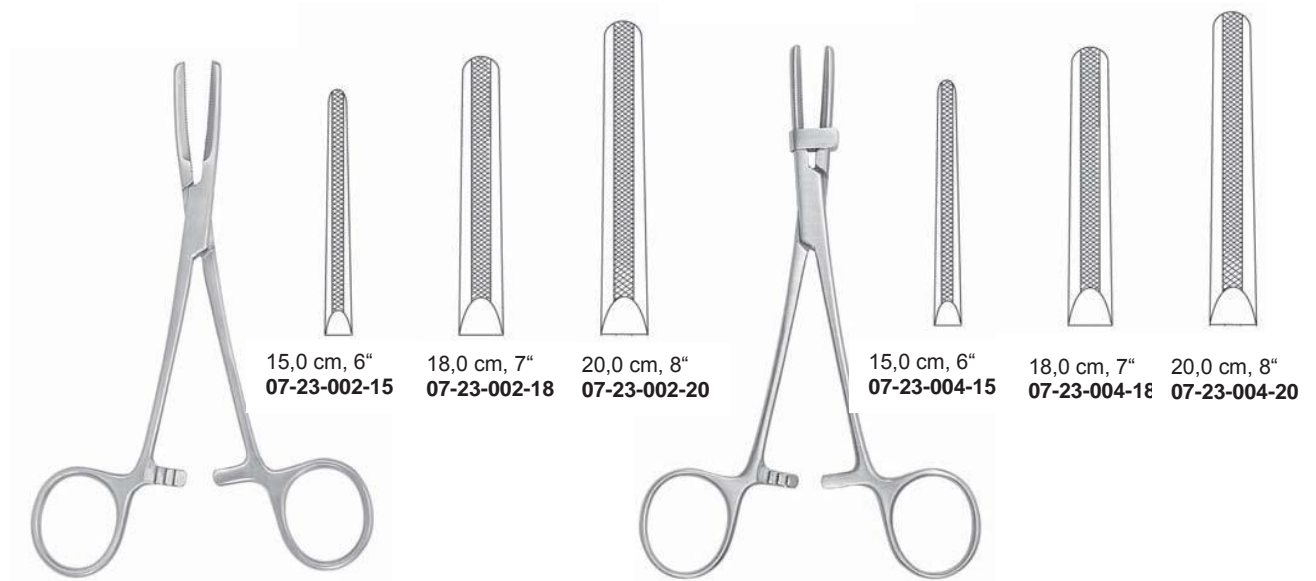

15,0 cm, 6"  
 07-23-002-15

18,0 cm, 7"  
 07-23-002-18

20,0 cm, 8"  
 07-23-002-20

15,0 cm, 6"  
 07-23-004-15

18,0 cm, 7"  
 07-23-004-18

20,0 cm, 8"  
 07-23-004-20

**Klemmen  
Forceps  
Pincers  
Pinas  
Зажимы, щипцы**







Bulldogklemmen  
Bulldog Clamps  
Clamps Bulldog  
Clamps Bulldog  
Зажимы типа „бульдог“



3,5 cm, 1½"	09-20-014-03	09-20-015-03
5,0 cm, 2"	09-20-014-05	09-20-015-05

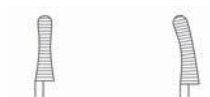

**DIEFFENBACH**



**HESS**  
09-20-520-01



**HESS**  
09-20-520-02



4,0 cm, 1½"	09-20-018-04	09-20-019-04
5,0 cm, 2"	09-20-018-05	09-20-019-05
5,5 cm, 2½"	09-20-018-06	09-20-019-05
6,5 cm, 2½"	09-20-018-07	09-20-019-07
7,0 cm, 1½"	09-20-018-08	09-20-019-08
7,5 cm, 3"	09-20-018-09	09-20-019-09
9,0 cm, 3½"	09-20-018-10	09-20-019-10

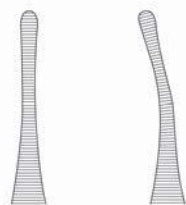

**JOHNS-HOPKINS**



**JOHNS-HOPKINS**  
23,0 cm, 9"  
09-20-295-23

**Bulldogklemmen**  
**Bulldog Clamps**  
**Clamps Bulldog**  
**Clamps Bulldog**  
**Зажимы типа „бульдог“**

mit atraumatischer Riefung  
with non-traumatic serration  
Clamps Atrauma Bulldog  
con bocas atraumáticas  
с атравматичной  
зазубренностью



L

7,5 cm, 3"	<b>09-20-292-07</b>	2,5 cm, 1"
8,5 cm, 3¼"	<b>09-20-292-08</b>	3,5 cm, 1⅜"
10,5 cm, 4⅛"	<b>09-20-292-10</b>	5,0 cm, 2"
12,0 cm, 4¾"	<b>09-20-292-12</b>	6,8 cm, 2¾"

**DE BAKEY**

mit atraumatischer Riefung  
with non-traumatic serration  
Clamps Atrauma Bulldog  
con bocas atraumáticas  
с атравматичной  
зазубренностью



L

7,0 cm, 2¾"	<b>09-20-293-07</b>	2,5 cm, 1"
8,0 cm, 3⅛"	<b>09-20-293-08</b>	3,5 cm, 1⅜"
10,0 cm, 3⅜"	<b>09-20-293-10</b>	5,0 cm, 2"
11,5 cm, 4½"	<b>09-20-293-12</b>	6,8 cm, 2¾"

**DE BAKEY**



**TITANIUM**  
3,5 cm, 1⅜"  
vena **09-21-032-35**  
arteria **09-21-042-35**



**TITANIUM**  
3,5 cm, 1⅜"  
vena **09-21-033-35**  
arteria **09-21-043-35**



**TITANIUM**  
4,0 cm, 1⅝"  
vena **09-21-032-40**  
arteria **09-21-042-40**



**TITANIUM**  
4,0 cm, 1⅝"  
vena **09-21-033-40**  
arteria **09-21-043-40**



Bulldogklemmen, Darm- und Gewebefazangen  
 Bulldog Clamps, Intestinal and Tissue Grasping Forceps  
 Clamps Bulldog, Pincers a saisir les intestins et les tissus  
 Clamps Bulldog, Pinzas intestinales y para tejidos

Зажимы типа „бульдог“, кишечные зажимы, зажимы для захватывания тканей

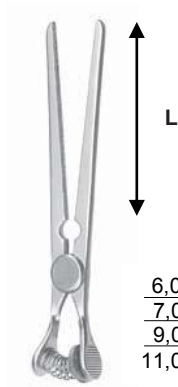

6,0 cm, 2 <sup>3</sup> / <sub>4</sub> "	<b>09-20-298-06</b>	3,3 cm, 1 <sup>3</sup> / <sub>8</sub> "
7,0 cm, 3 <sup>3</sup> / <sub>4</sub> "	<b>09-20-298-07</b>	5,0 cm, 2"
9,0 cm, 3 <sup>1</sup> / <sub>2</sub> "	<b>09-20-298-09</b>	6,0 cm, 2 <sup>3</sup> / <sub>4</sub> "
11,0 cm, 4 <sup>3</sup> / <sub>4</sub> "	<b>09-20-298-11</b>	6,9 cm, 2 <sup>3</sup> / <sub>4</sub> "

GLOVER

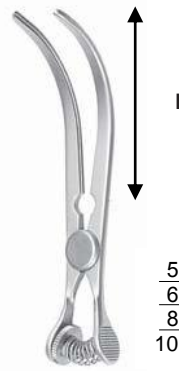

5,5 cm, 2"	<b>09-20-299-05</b>	3,3 cm, 1 <sup>3</sup> / <sub>8</sub> "
6,5 cm, 2 <sup>1</sup> / <sub>2</sub> "	<b>09-20-299-06</b>	3,3 cm, 1 <sup>3</sup> / <sub>8</sub> "
8,5 cm, 3"	<b>09-20-299-09</b>	5,0 cm, 2"
10,5 cm, 4 <sup>3</sup> / <sub>8</sub> "	<b>09-20-299-11</b>	6,9 cm, 2 <sup>3</sup> / <sub>4</sub> "

GLOVER



**CHAPUT**  
 13,0 cm, 5"  
 09-24-370-13



**TUFFIER**  
 13,0 cm, 5"  
 09-24-372-13



**COLLIN**  
 16,0 cm, 6<sup>1</sup>/<sub>4</sub>"  
 09-24-376-16



**Darm- und Gewebefaßzangen**  
**Intestinal and Tissue Grasping Forceps**  
**Pinces a saisir les intestins et les tissus**  
**Pinzas intestinales y para tejidos**  
**Кишечные зажимы для захватывания тканей**



15,5 cm, 6¼" **09-24-358-15**  
 20,0 cm, 8" **09-24-358-20**



25,0 cm, 10"  
**09-24-658-25**



26,0 cm, 10¼"  
**09-24-658-26**

**SCHEIBE**



**MARTEL**  
 14,0 cm, 5½"  
**09-24-364-14**



**WILLET-MARTEL**  
 19,0 cm, 7¼"  
**09-24-366-19**



Arterienklemmen  
Haemostatic Forceps  
Pinces hémostatiques  
Pinzas hemostáticas  
Зажимы кровоостанавливающие



**PRATT**  
15,0 cm, 6"  
09-24-656-15



**FERGUSSON**

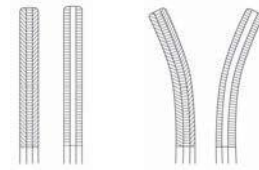

16,0 cm, 6¼" 09-24-650-16 09-24-651-16  
20,0 cm, 8" 09-24-650-20 09-24-651-20



**CARREL**  
8,5 cm, 3"  
09-24-010-08



**TERRIER**  
8,5 cm, 3" 09-24-016-08  
10,0 cm, 4" 09-24-016-10



**KROENLEIN**  
13,0 cm, 5"  
09-24-369-13

Arterienklemmen  
 Haemostatic Forceps  
 Pinces hémostatiques  
 Pinzas hemostáticas  
 Зажимы кровоостанавливающие



13,0 cm, 5"	09-24-368-13	-
14,0 cm, 5½"	09-24-368-14	09-24-369-14
16,0 cm, 6¼"	09-24-368-16	09-24-369-16

PEAN



09-24-475-01

09-24-475-02

BABY-MIXTER  
 14,0 cm, 5½"



13,0 cm, 5"	09-24-290-13	09-24-291-13
14,0 cm, 5½"	09-24-290-14	09-24-291-14
15,0 cm, 6"	09-24-290-15	09-24-291-15
18,0 cm, 7"	09-24-290-18	09-24-291-18
20,0 cm, 8"	09-24-290-20	09-24-291-20
23,0 cm, 9"	09-24-290-23	09-24-291-23

SPENCER-WELLS



9,0 cm, 3½"	09-24-000-09	09-24-001-09
10,0 cm, 4"	09-24-000-10	09-24-001-10

HARTMANN



Arterienklemmen  
Haemostatic Forceps  
Pinces hémostatiques  
Pinzas hemostáticas  
Зажимы кровоостанавливающие



09-24-140-14



09-24-141-14

**PROVICENCE-HOSPITAL**  
14,0 cm, 5½"



12,5 cm, 5" 09-24-050-12 09-24-051-12  
14,0 cm, 5½" 09-24-050-14 09-24-051-14

1 x 2

12,5 cm, 5" 09-24-070-12 09-24-071-12  
14,0 cm, 5½" 09-24-070-14 09-24-071-14

**HALSTED-MOSQUITO**



**HALSTED-MOSQUITO**

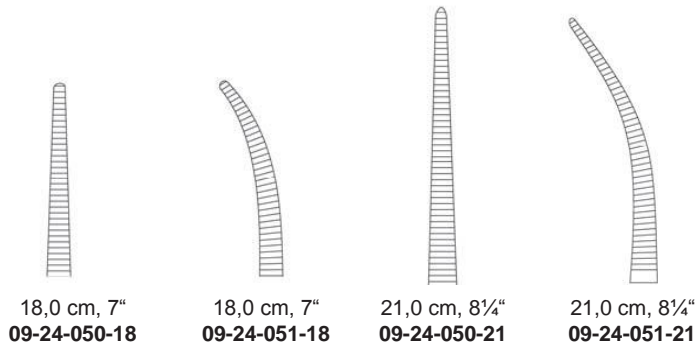

18,0 cm, 7"  
09-24-050-18

18,0 cm, 7"  
09-24-051-18

21,0 cm, 8¼"  
09-24-050-21

21,0 cm, 8¼"  
09-24-051-21

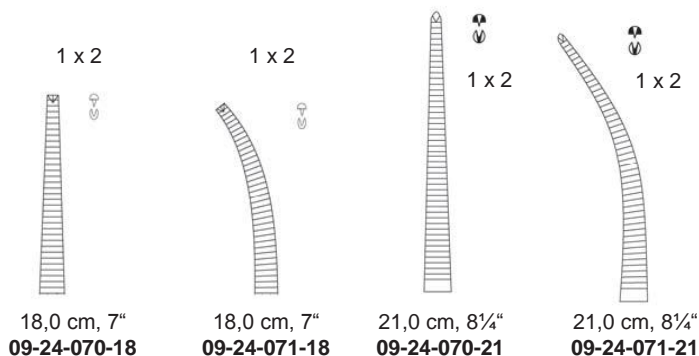

18,0 cm, 7"  
09-24-070-18

18,0 cm, 7"  
09-24-071-18

21,0 cm, 8¼"  
09-24-070-21

21,0 cm, 8¼"  
09-24-071-21

Arterienklemmen  
 Haemostatic Forceps  
 Pinces hémostatiques  
 Pinzas hemostáticas  
 Зажимы кровоостанавливающие



**MICRO-MOSQUITO**

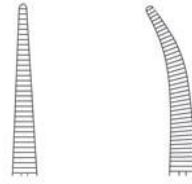

10,0 cm, 4" 09-24-020-10 09-24-021-10  
 12,5 cm, 4¾" 09-24-020-12 09-24-021-12

1 x 2 1 x 2

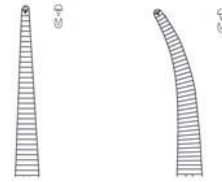

10,0 cm, 4" 09-24-030-10 09-24-031-10  
 12,5 cm, 4¾" 09-24-030-12 09-24-031-12



**KELLY**  
 14,0 cm, 5½"

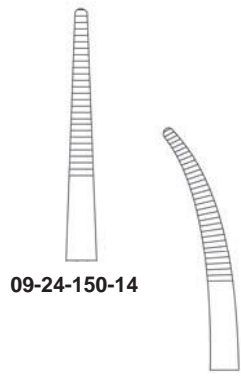

09-24-150-14

09-24-151-14



**KELLY-RANKIN**  
 16,0 cm, 6¼"

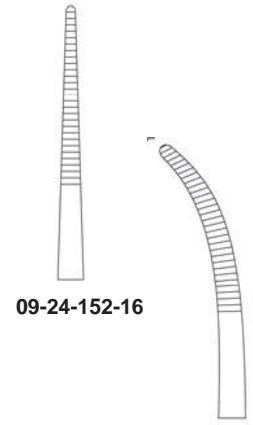

09-24-152-16

09-24-153-16

Arterienklemmen  
 Haemostatic Forceps  
 Pinces hémostatiques  
 Pinzas hemostáticas  
 Зажимы кровоостанавливающие



**LERICHE**  
 15,0 cm, 6"

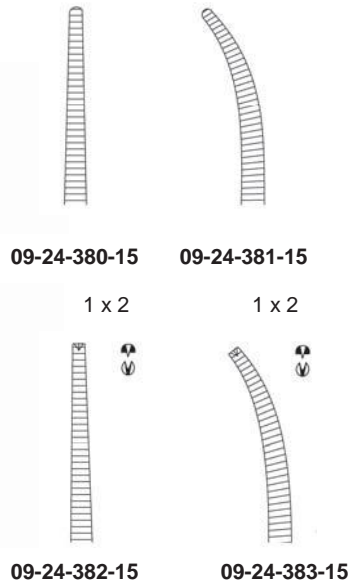

**BABY-OVERHOLT**  
 13,5 cm, 5¼"  
 09-24-424-14



**DANDY**  
 14,0 cm, 5½"

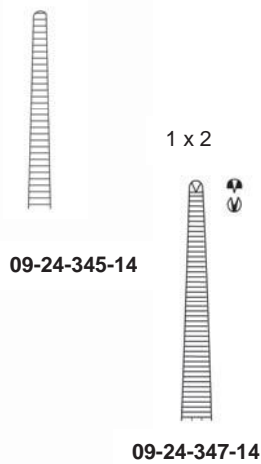

**CRILE**  
 14,0 cm, 5½"

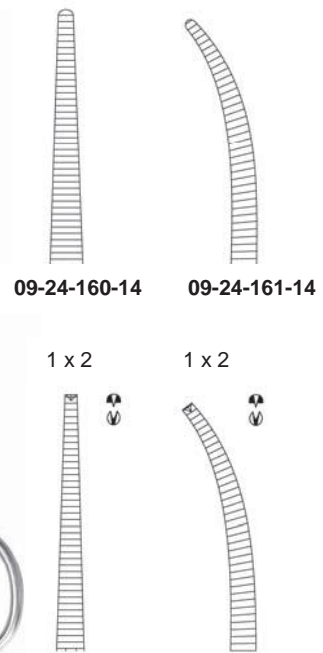

Arterienklemmen  
 Haemostatic Forceps  
 Pinces hémostatiques  
 Pinzas hemostáticas  
 Зажимы кровоостанавливающие



**DIXON-LOVELACE**  
 15,5 cm, 6<sup>3</sup>/<sub>4</sub>"

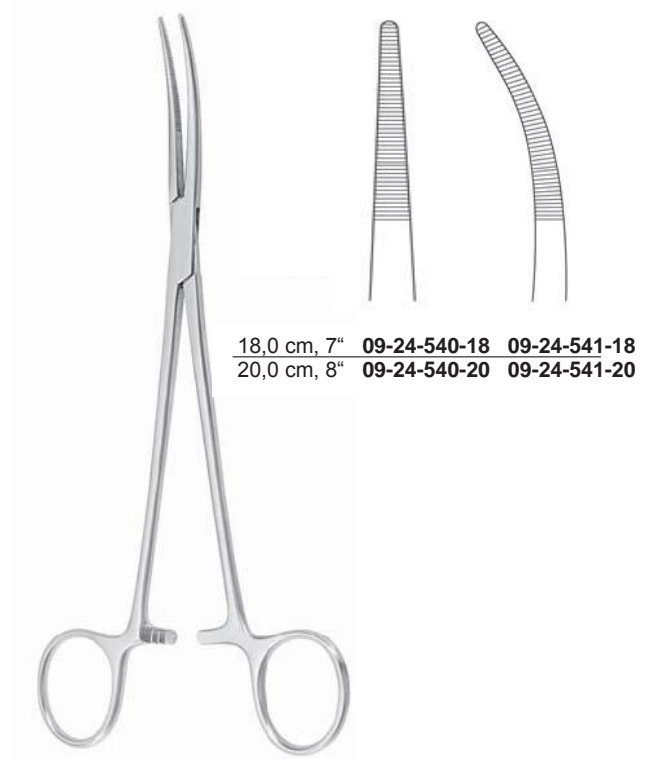

**BIRKETT**



**CRILE-RANKIN**  
 16,0 cm, 6<sup>3</sup>/<sub>4</sub>"

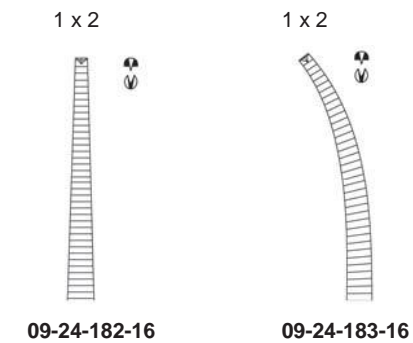
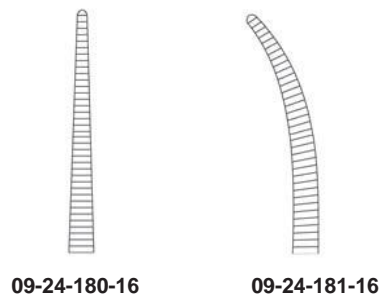





Arterienklemmen  
Haemostatic Forceps  
Pinces hémostatiques  
Pinzas hemostáticas  
Зажимы кровоостанавливающие



09-24-187-19



09-24-185-19

**SCHMIDT**  
19,0 cm, 7½"



09-24-183-19



09-24-181-19

**SCHMIDT-SAWTELL**  
19,0 cm, 7½"

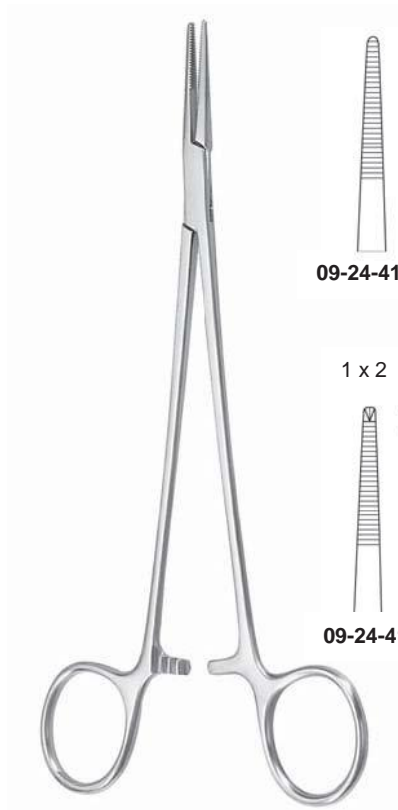

09-24-414-18



09-24-415-18

1 x 2

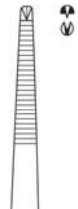

09-24-412-18

1 x 2



09-24-413-18

**ADSON**  
18,5 cm, 7¼"

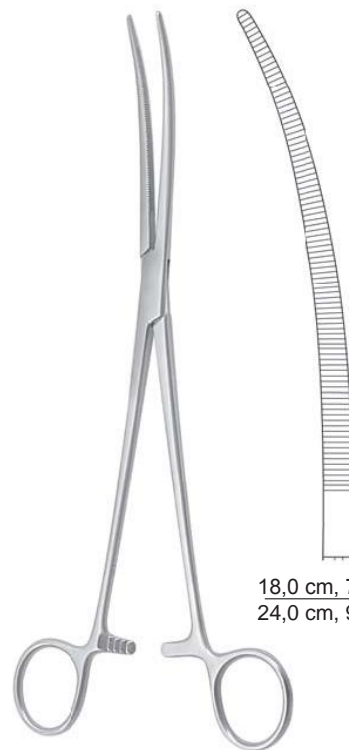

18,0 cm, 7" 09-24-453-18  
24,0 cm, 9½" 09-24-453-24

**CRAFOORD**



Arterienklemmen  
 Haemostatic Forceps  
 Pinces hémostatiques  
 Pinzas hemostáticas  
 Зажимы кровоостанавливающие



15,0 cm, 6" **09-24-480-15** **09-24-481-15**  
 18,5 cm, 7¼" **09-24-480-18** **09-24-481-18**

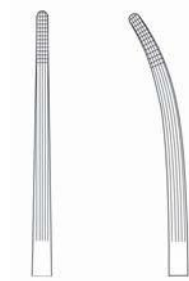

**BAINBRIDGE**



16,0 cm, 6¼" **09-24-340-16** **09-24-341-16**  
 20,0 cm, 8" **09-24-340-20** **09-24-341-20**

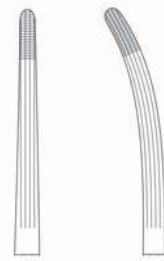

**ROCHESTER-CARMALT**



13,0 cm, 5" **09-24-262-13** **09-24-263-13**  
 14,0 cm, 5½" **09-24-262-14** **09-24-263-14**  
 16,0 cm, 6¼" **09-24-262-16** **09-24-263-16**

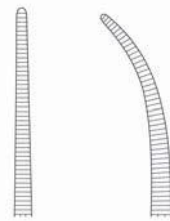

**PEAN DELICATE**

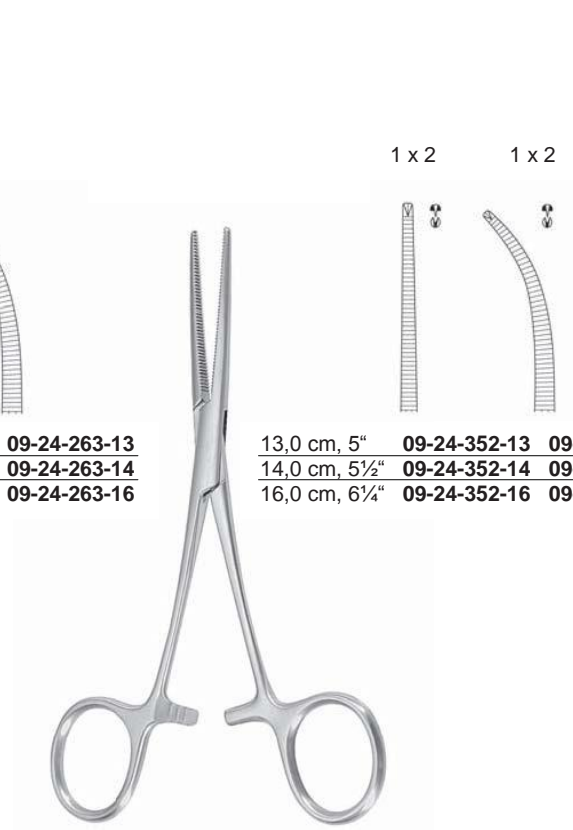

13,0 cm, 5" **09-24-352-13** **09-24-353-13**  
 14,0 cm, 5½" **09-24-352-14** **09-24-353-14**  
 16,0 cm, 6¼" **09-24-352-16** **09-24-353-16**

1 x 2      1 x 2

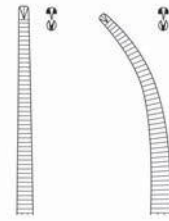

**KOCHER DELICATE**



Arterienklemmen  
Haemostatic Forceps  
Pinces hémostatiques  
Pinzas hemostáticas  
Зажимы кровоостанавливающие



ROCHESTER-PEAN

13,0 cm, 5"	09-24-260-13	09-24-261-13
14,0 cm, 5½"	09-24-260-14	09-24-261-14
16,0 cm, 6¼"	09-24-260-16	09-24-261-16
18,0 cm, 7"	09-24-260-18	09-24-261-18
20,0 cm, 8"	09-24-260-20	09-24-261-20
22,0 cm, 8⅝"	09-24-260-22	09-24-261-22
24,0 cm, 9½"	09-24-260-24	09-24-261-24
26,0 cm, 10¼"	09-24-260-26	09-24-261-26
30,0 cm, 12"	09-24-260-30	09-24-261-30

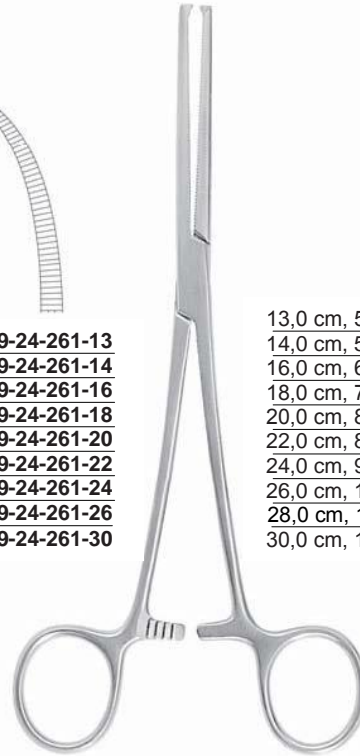

KOCHER-OCHSNER

13,0 cm, 5"	09-24-350-13	09-24-351-13
14,0 cm, 5½"	09-24-350-14	09-24-351-14
16,0 cm, 6¼"	09-24-350-16	09-24-351-16
18,0 cm, 7"	09-24-350-18	09-24-351-18
20,0 cm, 8"	09-24-350-20	09-24-351-20
22,0 cm, 8⅝"	09-24-350-22	09-24-351-22
24,0 cm, 9½"	09-24-350-24	09-24-351-24
26,0 cm, 10¼"	09-24-350-26	09-24-351-26
28,0 cm, 11"	-	09-24-351-28
30,0 cm, 12"	09-24-350-30	09-24-351-30



BENGOLEA

20,0 cm, 8"	09-24-384-20	09-24-385-20	09-24-386-20	09-24-387-20
24,0 cm, 10¼"	09-24-384-24	09-24-385-24	09-24-386-24	09-24-387-24
26,0 cm, 10¼"	09-24-384-26	09-24-385-26	09-24-386-26	09-24-387-26

Arterienklemmen  
 Haemostatic Forceps  
 Pincés hémostatiques  
 Pinzas hemostáticas  
 Зажимы кровоостанавливающие



09-24-390-20 09-24-391-20 09-24-393-20

**HEISS**  
 20,0 cm, 8"



09-24-448-22 09-24-449-22

**ROBERTS**  
 22,0 cm, 8<sup>5</sup>/<sub>8</sub>"

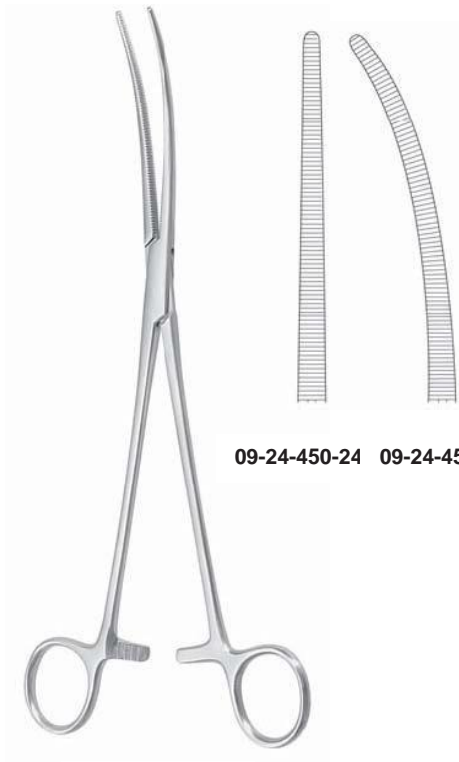

09-24-450-24 09-24-451-24

**SAROT**  
 24,0 cm, 9<sup>1</sup>/<sub>2</sub>"



09-24-533-01 09-24-533-02

**NEGUS**  
 19,0 cm, 7<sup>1</sup>/<sub>2</sub>"



Präparier- und Ligaturklemmen  
Dissecting and Ligature Forceps  
Pincers a disséquer et a ligatures  
Pinzas de disección y ligaduras  
Зажимы анатомические и лигатурные



14,0 cm, 5½"  
09-24-411-14



18,0 cm, 7"  
09-24-411-18

**BABY-ADSON**



**MICRO-ADSON**  
14,0 cm, 5½"  
09-24-409-14



**OVERHOLT-MIXTER**  
21,0 cm, 8¼"  
09-24-471-21



**JOHNS HOPKINS**  
20,0 cm, 8"  
09-24-497-20



**BABY-MIXTER**  
14,0 cm, 5½" 09-24-475-14  
16,0 cm, 6¾" 09-24-475-16  
18,0 cm, 7" 09-24-475-18

**Präparier- und Ligaturklemmen**  
**Dissecting and Ligature Forceps**  
**Pinces a disséquer et a ligatures**  
**Pinzas de disección y ligaduras**  
**Зажимы анатомические и лигатурные**



**OVERHOLT**

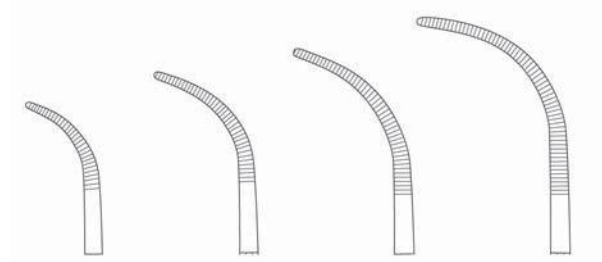

18,5 cm, 7¼"  
09-24-423-01

20,0 cm, 8"  
09-24-423-02

21,0 cm, 8¼"  
09-24-423-03

21,5 cm, 8½"  
09-24-423-04



**RUMEL**  
23,0 cm, 9"

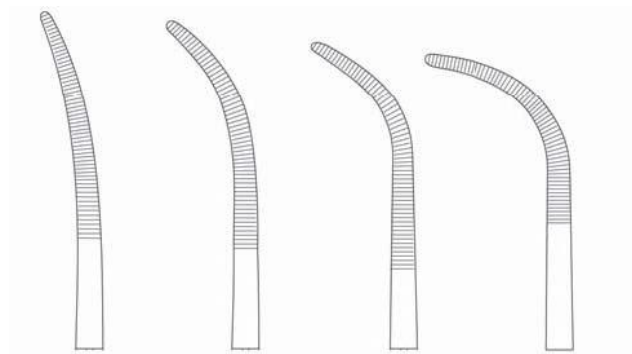

09-24-441-01

09-24-441-02

09-24-441-03

09-24-441-04



OVERHOLT-GEISSENDOERFER  
21,0 cm, 8¼"

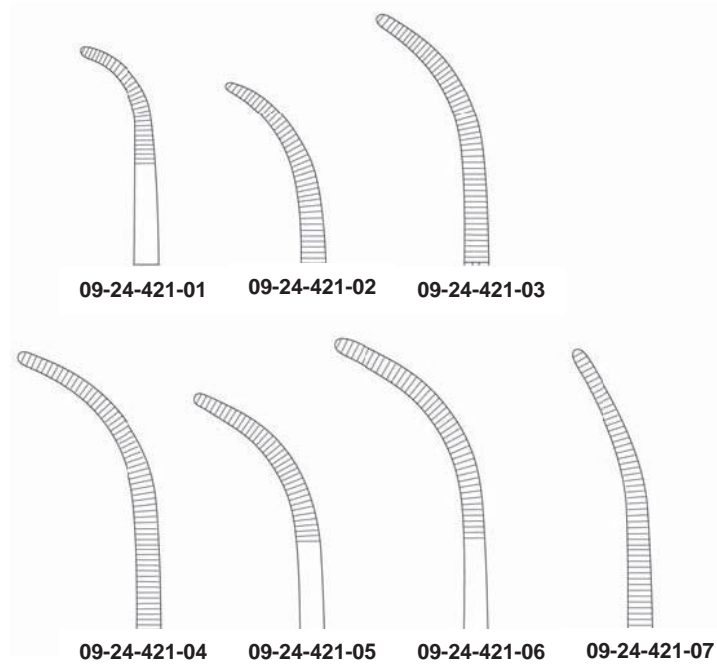

OVERHOLT-GEISSENDOERFER  
27,0 cm, 10¾"

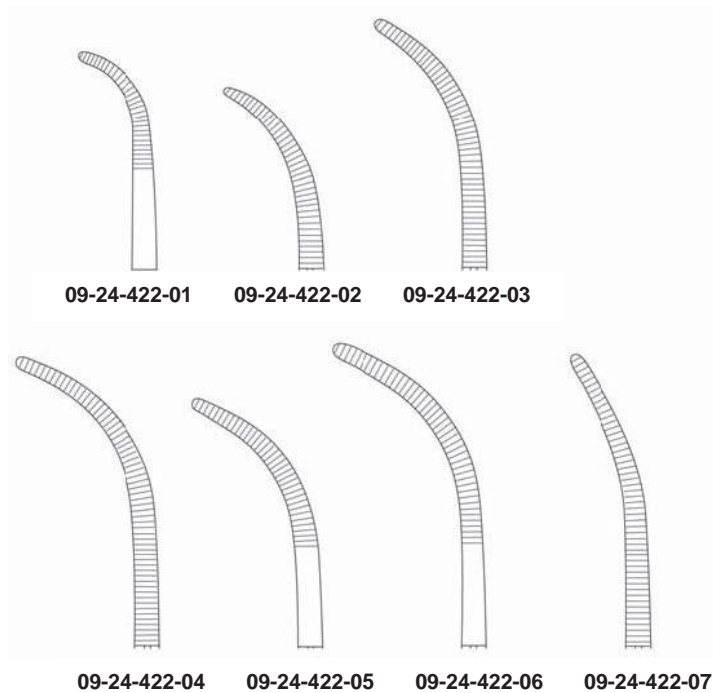

**Präparier- und Ligaturklemmen**  
**Dissecting and Ligature Forceps**  
**Pinces a disséquer et a ligatures**  
**Pinzas de disección y ligaduras**  
**Зажимы анатомические и лигатурные**



**TOENNIS**

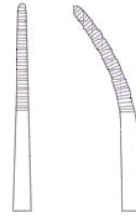

21,0 cm, 8¼"    **09-24-442-21**    **09-24-443-21**  
26,0 cm, 10¼"    **09-24-442-26**    **09-24-443-26**

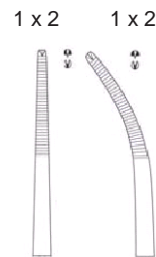

21,0 cm, 8¼"    **09-24-444-21**    **09-24-445-21**  
26,0 cm, 10¼"    **09-24-444-26**    **09-24-445-26**



**KELLY**

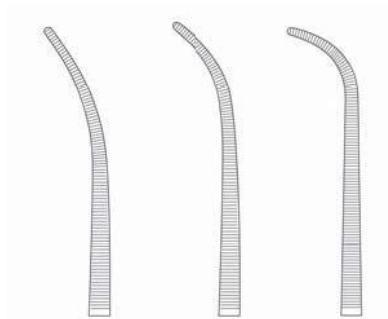

19,0 cm, 7½"    **09-24-463-19**    **09-24-465-19**    **09-24-467-19**  
22,0 cm, 8⅝"    **09-24-463-22**    **09-24-465-22**    **09-24-467-22**  
24,0 cm, 9½"    **09-24-463-24**    **09-24-465-24**    **09-24-467-24**



Präparier- und Ligaturklemmen  
Dissecting and Ligature Forceps  
Pincers a disséquer et a ligatures  
Pinzas de disección y ligaduras  
Зажимы анатомические и лигатурные



- 18,0 cm, 7" 09-24-429-18
- 22,0 cm, 8<sup>5</sup>/<sub>8</sub>" 09-24-429-22
- 25,0 cm, 9<sup>3</sup>/<sub>4</sub>" 09-24-429-25
- 28,0 cm, 11" 09-24-429-28

MINI-GEMINI



- 13,0 cm, 5" 09-24-431-13
- 16,0 cm, 6<sup>1</sup>/<sub>4</sub>" 09-24-431-16
- 18,0 cm, 7" 09-24-431-18
- 20,0 cm, 8" 09-24-431-20
- 23,0 cm, 9" 09-24-431-23
- 25,0 cm, 9<sup>3</sup>/<sub>4</sub>" 09-24-431-25
- 28,0 cm, 11" 09-24-431-28

GEMINI



- 19,0 cm, 7<sup>1</sup>/<sub>2</sub>" 09-24-433-19
- 24,0 cm, 9<sup>1</sup>/<sub>2</sub>" 09-24-433-24
- 28,0 cm, 11" 09-24-433-28

KANTROWITZ



- 19,0 cm, 7<sup>1</sup>/<sub>2</sub>" 09-24-543-19
- 21,0 cm, 8<sup>1</sup>/<sub>4</sub>" 09-24-543-21
- 24,0 cm, 9<sup>1</sup>/<sub>2</sub>" 09-24-543-24

WIKSTROEM



**Präparier- und Ligaturklemmen**  
**Dissecting and Ligature Forceps**  
**Pinces a disséquer et a ligatures**  
**Pinzas de disección y ligaduras**  
**Зажимы анатомические и лигатурные**



15,5 cm, 6¼" 09-24-461-15  
 19,0 cm, 7½" 09-24-461-19

MIXER



15,5 cm, 6¼" 09-24-477-15  
 19,0 cm, 7½" 09-24-477-19

MIXTER-O'SHAUGNESSY



**MIXTER**  
 22,0 cm, 8¾"  
 09-24-473-22



**MIXTER**  
 23,0 cm, 9"  
 09-24-473-23

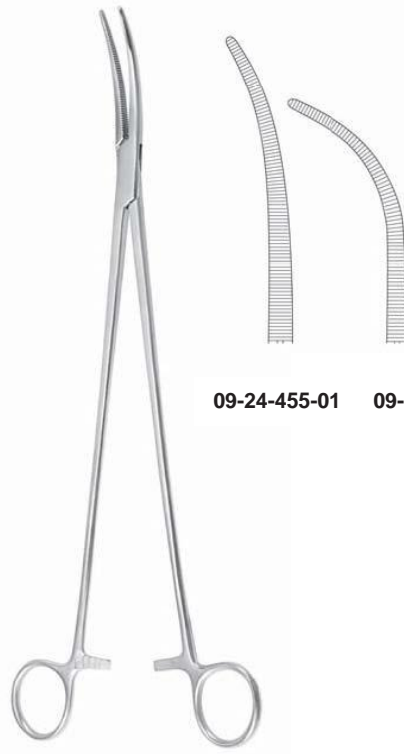

09-24-455-01 09-24-455-02

**ZENKER**  
 29,5 cm, 11½"



18,0 cm, 7" 09-24-459-18  
 28,0 cm, 11" 09-24-459-28

**MEEKER**



Präparier- und Ligaturklemmen  
Dissecting and Ligature Forceps  
Pincas a disséquer et a ligatures  
Pinzas de disección y ligaduras  
Зажимы анатомические и лигатурные



**LAWRENCE**  
27,5 cm, 10¾"  
09-24-457-28



**HOSEMANN**  
21,0 cm, 8¼"



**DESJARDINS**  
21,0 cm, 8¼"  
09-24-529-21



**MIXTER**  
22,0 cm, 8¾" 09-24-479-22  
25,0 cm, 9¾" 09-24-479-25  
28,0 cm, 11" 09-24-479-28



**LAHEY**  
19,0 cm, 7½" 09-24-501-19  
23,0 cm, 9" 09-24-501-23



**LOWER**  
18,0 cm, 7"  
09-24-503-18

**Präparier- und Ligaturklemmen**  
**Dissecting and Ligature Forceps**  
**Pinces a disséquer et a ligatures**  
**Pinzas de disección y ligaduras**  
**Зажимы анатомические и лигатурные**



**MC QUIGG-MIXTER**  
 22,0 cm, 8¾"  
 09-24-507-22



**GRAY**

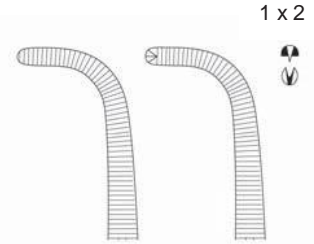

22,0 cm, 8¾"	<b>09-24-523-22</b>	<b>09-24-525-22</b>
23,0 cm, 9"	<b>09-24-523-23</b>	<b>09-24-525-23</b>



**CRAFOORD-SELLORS**

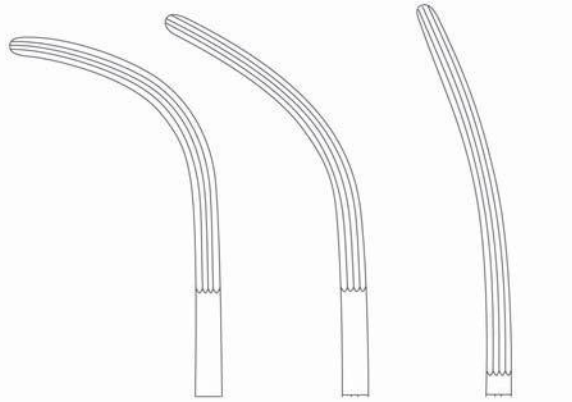

22,0 cm, 8¾"	23,0 cm, 9"	24,0 cm, 9½"
<b>09-24-456-22</b>	<b>09-24-456-23</b>	<b>09-24-456-24</b>

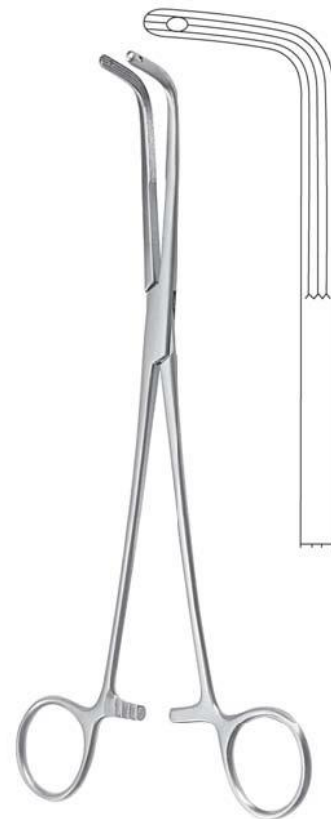

**FINOCCHIETTO**  
 24,0 cm, 9½"  
 09-24-505-24

Gallenkanal- und Nierenstielklemmen  
 Gall Duct and Kidney Pedicle Clamps  
 Pince-clamps pour pédiculés rénaux, Pincas pour les voies biliaires  
 Pinzas-clamps para pedúnculo renal, Pinzas para conducto biliar  
 Зажим для желчного протока и для почечной ножки



20,0 cm, 8" 09-24-509-20  
 22,0 cm, 8¾" 09-24-509-22  
 24,0 cm, 9½" 09-24-509-24

GUYON



GUYON  
 23,0 cm, 9"  
 09-24-513-23



23,0 cm, 9" 09-24-519-23  
 24,0 cm, 9½" 09-24-519-24

GUYON



STILLE  
 23,0 cm, 9"  
 09-24-511-23

Gallenkanal- und Nierenstiellklemmen, Bronchusklemmen  
 Gall Duct and Kidney Pedicle Clamps, Bronchus Forceps  
 Pince-clamps pour pédiculés rénaux,  
 Pincers pour les voies biliaires, Bronches pincer  
 Pinzas-clamps para pedúnculo renal, Pinzas-clamps para bronquios  
 Зажим для желчного протока и для почечной ножки, бронхиальный зажим



**HERRICK**  
 23,0 cm, 9"  
 09-24-517-23



**URO-TANGENTIAL**  
 26,0 cm, 10¼"

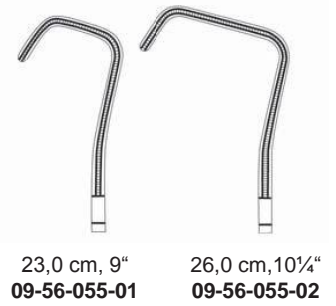

23,0 cm, 9"  
 09-56-055-01

26,0 cm, 10¼"  
 09-56-055-02



**LOVELACE**  
 20,0 cm, 8"  
 09-48-004-20



**LOVELACE**  
 20,0 cm, 8"  
 09-48-005-20



**PRICE-THOMAS**  
 22,0 cm, 8¾"  
 09-48-001-22



Bronchusklemmen, Peritoneumklemmen, Hysterektomieklemmen  
Bronchus Forceps, Peritoneum Forceps, Hysterectomy Forceps  
Bronches pincer, Pincers a péritoine, Pincers a hystérectomie  
Pinzas-clamps para bronquios, Pinzas-clamps para peritoneo y para histerectomía  
Бронхеальные зажимы, щипцы для брюшины, Щипцы гистерэктомические



09-48-002-01

09-48-002-02

**PRICE-THOMAS**  
22,0 cm, 8¾"



09-48-003-01 09-48-003-02

**SEMB**  
23,0 cm, 9"



1 x 2

**BABY-MIKULICZ**  
14,0 cm, 5½"  
09-24-701-14



1 x 2

**MIKULICZ**  
18,0 cm, 7"  
09-24-703-18



1 x 2

**MIKULICZ**  
20,0 cm, 8"  
09-24-709-20



Peritoneumklemmen, Hysterektomieklemmen  
 Peritoneum Forceps, Hysterectomy Forceps  
 Pincès a péritoine, Pincès a hystérectomie  
 Pinzas-clamps para peritoneo y para histerectomía  
 Щипцы для брюшины, щипцы гистерэктомические



**FAURE**  
 20,0 cm, 8"

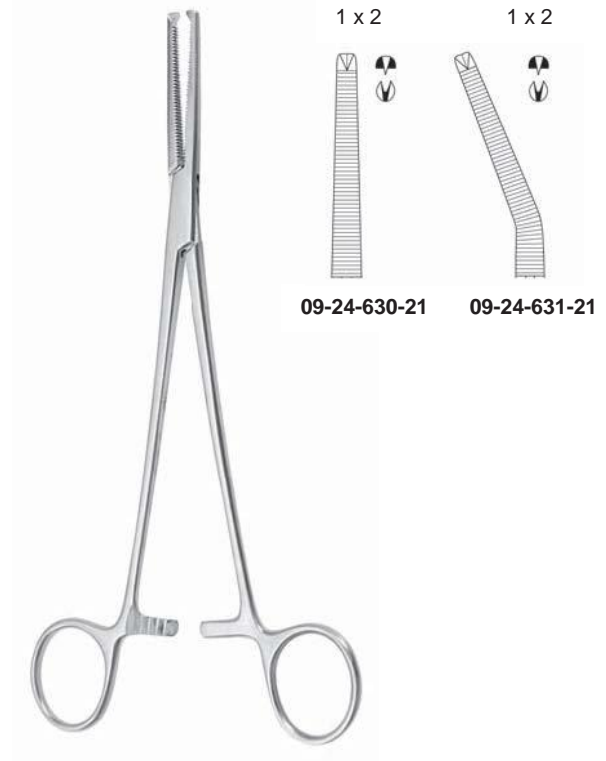

**PHANEUF**  
 21,5 cm, 8½"

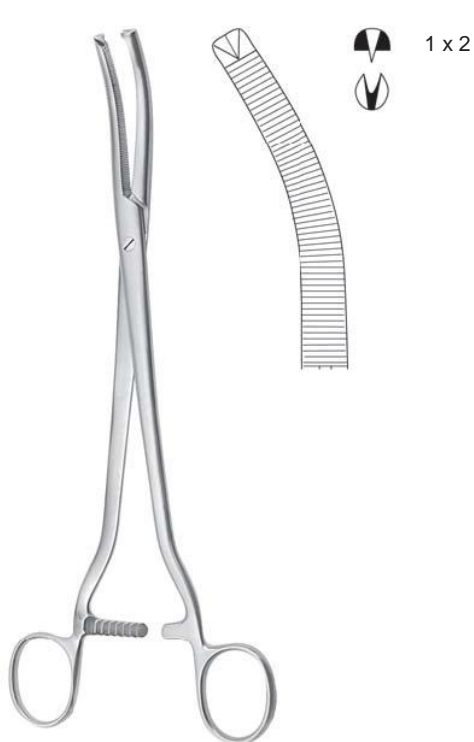

**WERTHEIM**  
 22,0 cm, 8¾"  
 09-24-601-22



**WERTHEIM**  
 25,0 cm, 10"  
 09-24-602-25

Hysterektomieklemmen  
 Hysterectomy Forceps  
 Pinzas a hystérectomie  
 Pinzas-clamps para histerectomía  
 Щипцы гистерэктомические



1 x 2  
 22,0 cm, 8¾"  
 09-24-603-22

1 x 2  
 23,0 cm, 9"  
 09-24-603-23

WERTHEIM



1 x 2  
 20,0 cm, 8"  
 09-24-606-20

1 x 2  
 25,0 cm, 10"  
 09-24-606-25

MAINGOT



23,0 cm, 9"  
 09-24-625-23

24,0 cm, 9½"  
 09-24-625-24

MOYNIHAN



WERTHEIM-CULLEN  
 21,5 cm, 8½"  
 09-24-629-21



Hysterektomieklemmen  
 Hysterectomy Forceps  
 Pinces a hystérectomie  
 Pinzas-clamps para histerectomía  
 Щипцы гистерэктомические



**LONG**  
 19,0 cm, 7¼"  
 09-24-621-19



**GARLAND**  
 21,0 cm, 8¼"  
 09-24-623-21



**HEANEY-BALLANTINE**  
 21,0 cm, 8¼"

09-24-614-21    09-24-615-21

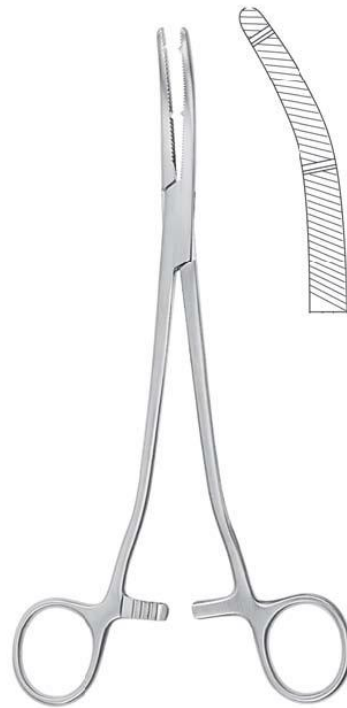

**HEANEY-KANTER**  
 21,0 cm, 8¼"  
 09-24-617-21



Hysterektomieklemmen  
Hysterectomy Forceps  
Pinzas a hystérectomie  
Pinzas-clamps para hysterectomía  
Щипцы гистерэктомические



HEANEY

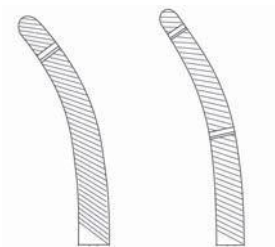

21,0 cm, 8¼"	09-24-611-21	09-24-613-21
23,0 cm, 9"	09-24-611-23	09-24-613-23

**Nahtinstrumente**  
**Suture Instruments**  
**Instrumentos a suture**  
**Instrumentos para sutura**  
**ШОВНЫЙ ИНСТРУМЕНТ**







**DERF**



**COLLIER**  
12,5 cm, 5"  
11-25-022-12



**WEBSTER**  
13,0 cm, 5"  
11-25-028-13

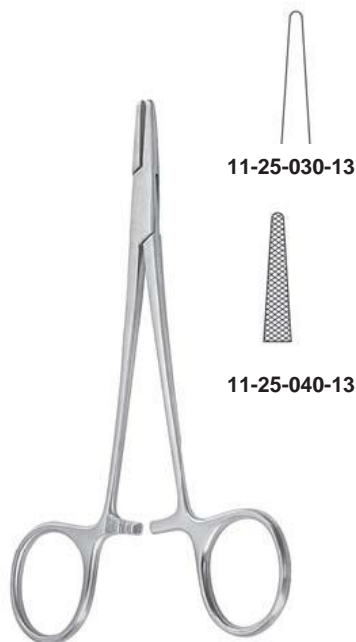

**HALSEY**  
13,0 cm, 5"



**NEIVERT**  
13,0 cm, 5"  
11-25-046-13



**HEGAR-BAUMGARTNER**  
12,5 cm, 4 3/4" 11-25-048-12  
14,0 cm, 5 1/2" 11-25-048-14

**Nadelhalter  
Needle Holders  
Porte-aiguilles  
Porta-agujas  
Иглодержатели**



13,0 cm, 5" 11-25-096-13  
18,0 cm, 7" 11-25-096-18

**BROWN**



**CRILE-MURRAY**  
15,0 cm, 6"  
11-25-070-15



**CRILE-WOOD**

15,0 cm, 6" 11-25-060-15  
18,0 cm, 7" 11-25-060-18  
20,0 cm, 8" 11-25-060-20  
23,0 cm, 9" 11-25-060-23



**ADSON**  
16,0 cm, 6 1/4" 11-25-192-16  
18,0 cm, 7" 11-25-192-18



**METZENBAUM**  
18,0 cm, 7"  
11-25-190-18



**MASS.-GENERAL-HOSPITAL**  
17,0 cm, 6 3/4"  
11-25-072-17



**MAYO-HEGAR**



14,0 cm, 5½"  
11-25-080-14



16,0 cm, 6¼"  
11-25-080-16



18,0 cm, 7"  
11-25-080-18



20,0 cm, 8"  
11-25-080-20



24,0 cm, 9½"  
11-25-080-24



26,0 cm, 10¼"  
11-25-080-26



30,0 cm, 12"  
11-25-080-30



**MAYO-HEGAR-DELICATE**



16,0 cm, 6¼"  
11-25-090-16



18,0 cm, 7"  
11-25-090-18



20,0 cm, 8"  
11-25-090-20



**LAWRENCE**  
15,0 cm, 6"  
11-25-110-15

Nadelhalter  
 Needle Holders  
 Porte-aiguilles  
 Porta-agujas  
 Иглодержатели



**HEANEY**  
 21,0 cm, 8¼"  
 11-25-141-21



**JAMISON**  
 23,5 cm, 9¼"  
 11-25-148-23



**MASSON**  
 27,0 cm, 10½"  
 11-25-150-27



**FINOCCHIETTO**  
 20,0 cm, 8" 11-25-211-20  
 27,0 cm, 10½" 11-25-211-27



**WANGENSTEEN**  
 27,0 cm, 10½"  
 11-25-160-27



**JOHNSON**  
 27,0 cm, 10½"  
 11-25-193-27





Nadelhalter  
Needle Holders  
Porte-aiguilles  
Porta-agujas  
Иглодержатели

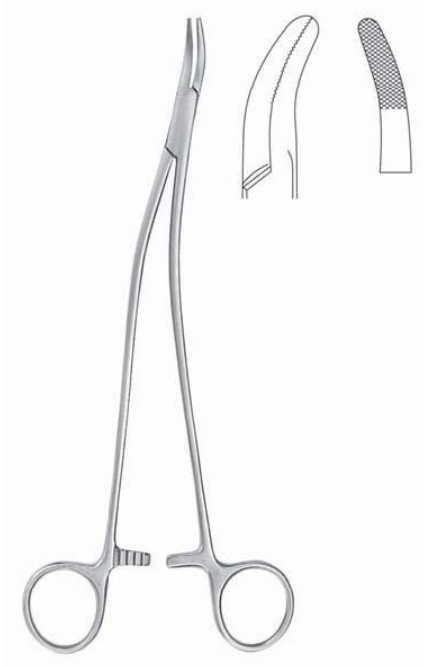

**STRATTE**  
23,0 cm, 9"  
11-25-230-23



**OLSEN-HEGAR**  
17,0 cm, 6¾"  
11-25-310-17

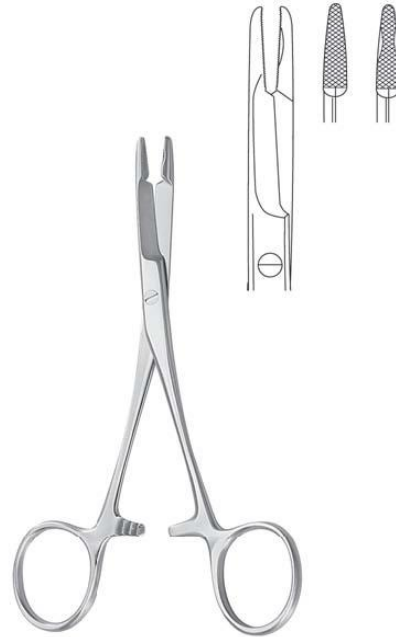

**OLSEN-HEGAR**  
14,0 cm, 5½"  
11-25-306-14



14,0 cm, 5½" 11-25-310-14  
17,0 cm, 6¾" 11-25-310-17.1  
18,0 cm, 7" 11-25-310-18  
19,0 cm, 7½" 11-25-310-19

**OLSEN-HEGAR**



**TOENNIS**  
18,0 cm, 7"  
11-25-362-18

Nadelhalter  
 Needle Holders  
 Porte-aiguilles  
 Porta-agujas  
 Иглодержатели



**MATHIEU**



Fig. 1



Fig. 2



Fig. 3

14,0 cm, 5½"	11-25-350-14.1	11-25-350-14.2	11-25-350-14.3
17,0 cm, 6¾"	11-25-350-17.1	11-25-350-17.2	11-25-350-17.3
20,0 cm, 8"	11-25-350-20.1	11-25-350-20.2	11-25-350-20.3
24,0 cm, 9½"	11-25-350-24.1	11-25-350-24.2	11-25-350-24.3



**MATHIEU**



14,0 cm, 5½"  
11-25-356-14



17,0 cm, 6¾"  
11-25-356-17



20,0 cm, 8"  
11-25-356-20



**LICHTENBERG**



14,0 cm, 5½"	11-25-366-14
17,0 cm, 6¾"	11-25-366-17
20,0 cm, 8"	11-25-366-20



**MATHIEU**



Fig. 1



Fig. 2



Fig. 3

14,0 cm, 5½"	11-25-354-14.1	11-25-354-14.2	11-25-354-14.3
17,0 cm, 6¾"	11-25-354-17.1	11-25-354-17.2	11-25-354-17.3
20,0 cm, 8"	11-25-354-20.1	11-25-354-20.2	11-25-354-20.3



MATHIEU-KOCHER



14,0 cm, 5½"  
11-25-358-14



17,0 cm, 6¾"  
11-25-358-17



20,0 cm, 8"  
11-25-358-20

**Nadelhalter mit Hartmetalleinlagen**  
**Needle Holders with tungsten carbide inserts**  
**Porte-aiguilles avec inserts en carbure tungstène**  
**Porta-agujas con bocas de carburo tungsteno**  
**Иглодержатели с твердосплавной вставкой**



**KALT**  
 13,5 cm, 5 $\frac{3}{8}$ "  
 1126-428-14



11-26-428-14



11-26-429-14



11-26-430-14



11-26-431-14



**DIETHRICH**

1 mm



16,0 cm, 6 $\frac{3}{4}$ " 11-26-250-16 11-26-251-16

18,0 cm, 7" 11-26-250-18 11-26-251-18

20,0 cm, 8" 11-26-250-20 11-26-251-20

23,0 cm, 9" 11-26-250-23 11-26-251-23

26,0 cm, 10 $\frac{1}{4}$ " 11-26-250-26 11-26-251-26

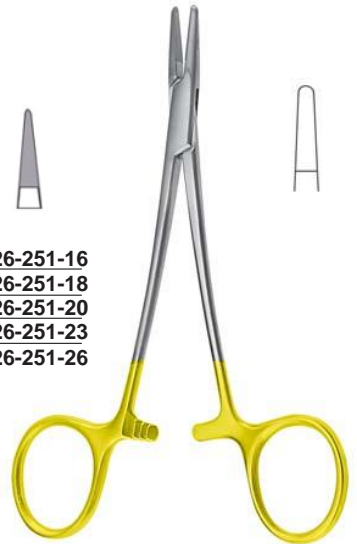

**WEBSTER**  
 13,0 cm, 5"  
 11-26-028-13



**DERF**  
 12,0 cm, 4 $\frac{3}{4}$ "  
 11-26-010-12



**HEGAR-BAUMGARTNER**



12,5 cm, 5"  
 11-26-048-12



14,0 cm, 5 $\frac{1}{2}$ "  
 11-26-048-14



**WEBSTER**  
 13,0 cm, 5"  
 11-26-029-13

Nadelhalter mit Hartmetalleinlagen  
 Needle Holders with tungsten carbide inserts  
 Porte-aiguilles avec inserts en carbure tungstène  
 Porta-agujas con bocas de carburo tungsteno  
 Иглодержатели с твердосплавной вставкой



**HALSEY**  
 13,0 cm, 5"



11-26-030-13



11-26-040-13



**CRILE-WOOD**



15,0 cm, 6"	11-26-060-15
18,0 cm, 7"	11-26-060-18
20,0 cm, 8"	11-26-060-20
23,0 cm, 9"	11-26-060-23



**SAROT**



Fig. 1

18,0 cm, 7"  
 11-26-224-18



Fig. 2

20,0 cm, 8"  
 11-26-224-20



Fig. 3

26,0 cm, 10 1/4"  
 11-26-224-26

Nadelhalter mit Hartmetalleinlagen  
 Needle Holders with tungsten carbide inserts  
 Porte-aiguilles avec inserts en carbure tungstène  
 Porta-agujas con bocas de carburo tungsteno  
 Иглодержатели с твердосплавной вставкой



**MAYO-HEGAR**



16,0 cm, 6¼"  
11-26-080-16



18,0 cm, 7"  
11-26-080-18



20,0 cm, 8"  
11-26-080-20



24,0 cm, 8"  
11-26-080-24



26,0 cm, 10¼"  
11-26-080-26



30,0 cm, 12"  
11-26-080-30



**MAYO-HEGAR (HEANEY)**



20,0 cm, 8"  
11-26-141-20



24,0 cm, 9¼"  
11-26-141-24



26,0 cm, 10¼"  
11-26-141-26



Nadelhalter mit Hartmetalleinlagen  
Needle Holders with tungsten carbide inserts  
Porte-aiguilles avec inserts en carbure tungstène  
Porta-agujas con bocas de carburo tungsteno  
Иглодержатели с твердосплавной вставкой



DE BAKEY



15,0 cm, 6"  
11-26-114-15



18,0 cm, 7"  
11-26-114-18



20,0 cm, 8"  
11-26-114-20



23,0 cm, 9"  
11-26-114-23



26,0 cm, 10 1/4"  
11-26-114-26



31,0 cm, 12 1/4"  
11-26-114-31



37,0 cm, 14 1/2"  
11-26-114-37

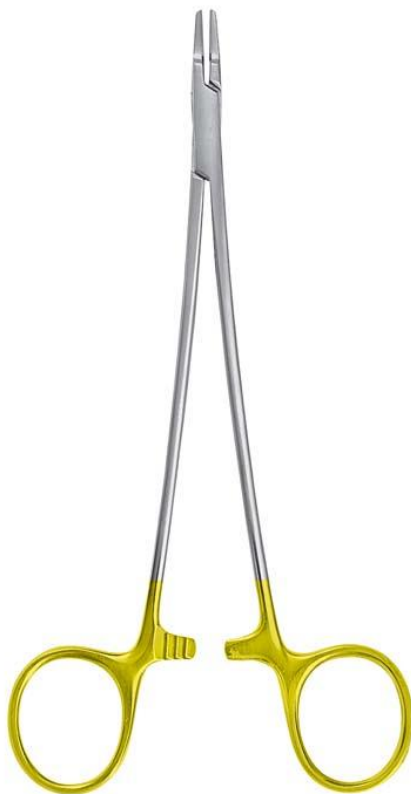

RYDER-VASCULAR



13,0 cm, 5"  
11-26-132-13



15,0 cm, 6"  
11-26-132-15



18,0 cm, 7"  
11-26-132-18



20,0 cm, 8"  
11-26-132-20

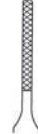

23,0 cm, 9"  
11-26-132-23

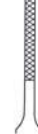

26,0 cm, 10 1/4"  
11-26-132-26

**Nadelhalter mit Hartmetalleinlagen**  
**Needle Holders with tungsten carbide inserts**  
**Porte-aiguilles avec inserts en carbure tungstène**  
**Porta-agujas con bocas de carburo tungsteno**  
**Иглодержатели с твердосплавной вставкой**

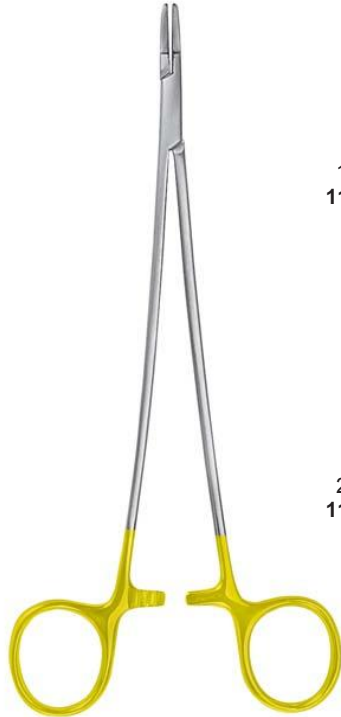

**RYDER**



13,0 cm, 5"  
11-26-134-13

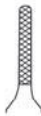

15,0 cm, 6"  
11-26-134-15



18,0 cm, 7"  
11-26-134-18



20,0 cm, 8"  
11-26-134-20

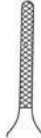

23,0 cm, 9"  
11-26-134-23

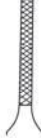

26,0 cm, 10½"  
11-26-134-26

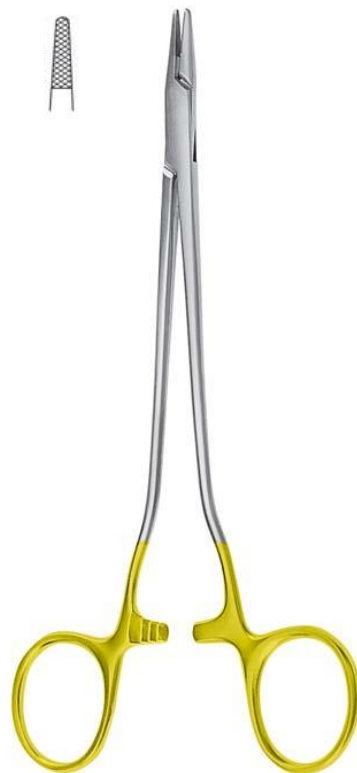

**SCHWEDISCHES MODELL**  
 15,0 cm, 6"  
 11-26-136-15



Nadelhalter mit Hartmetalleinlagen  
 Needle Holders with tungsten carbide inserts  
 Porte-aiguilles avec inserts en carbure tungstène  
 Porta-agujas con bocas de carburo tungsteno  
 Иглодержатели с твердосплавной вставкой

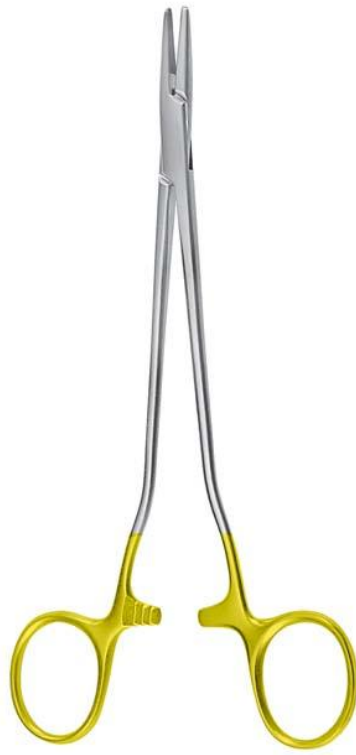

SAROT



Fig. 1

18,0 cm, 7"  
 11-26-090-18



Fig. 2

20,0 cm, 8"  
 11-26-090-20



Fig. 3

26,0 cm, 9"  
 11-26-090-26



**FINOCCHIETTO**  
 20,0 cm, 8" 11-26-211-20  
 27,0 cm, 10¾" 11-26-211-27



**MASSON**  
 27,0 cm, 10½"  
 11-26-150-27



**WANGENSTEEN**  
 27,0 cm, 10½"  
 11-26-160-27

**Nadelhalter mit Hartmetalleinlagen**  
**Needle Holders with tungsten carbide inserts**  
**Porte-aiguilles avec inserts en carbure tungstène**  
**Porta-agujas con bocas de carburo tungsteno**  
**Иглодержатели с твердосплавной вставкой**



**BOZEMANN**



20,0 cm, 8"  
11-26-185-20



24,0 cm, 9<sup>5</sup>/<sub>8</sub>"  
11-26-185-24



26,0 cm, 10<sup>1</sup>/<sub>4</sub>"  
11-26-185-26



**HEGAR**



20,0 cm, 8"  
11-26-084-20



24,0 cm, 9<sup>5</sup>/<sub>8</sub>"  
11-26-084-24



**BARRY STERNAL**



15,0 cm, 6"  
11-26-240-15



20,0 cm, 8"  
11-26-242-20

Nadelhalter mit Hartmetalleinlagen  
 Needle Holders with tungsten carbide inserts  
 Porte-aiguilles avec inserts en carbure tungstène  
 Porta-agujas con bocas de carburo tungsteno  
 Иглодержатели с твердосплавной вставкой



**HALSEY**  
13 cm / 5"

**11-3105-13D**  
Hartmetalleinsätze /  
Tungsten Carbide Insert Jaws\* /  
Твердосплавные вставки

**11-3105-13**  
Wolfram-Carbid-Beschichtung /  
Wolfram Carbide Tip Coating /  
Покрытие из карбида вольфрама



**CRILE-WOOD**  
15 cm / 6"

**11-3130-15D**  
Hartmetalleinsätze /  
Tungsten Carbide Insert Jaws\* /  
Твердосплавные вставки

**11-3130-15**  
Wolfram-Carbid-Beschichtung /  
Wolfram Carbide Tip Coating /  
Покрытие из карбида вольфрама



15 cm / 6"

**11-3280-15**  
Hartmetalleinsätze / Tungsten Carbide Insert  
Jaws / Твердосплавные вставки



**MAYO-HEGAR**  
14 cm / 5 1/2"

**11-3195-14D**  
Hartmetalleinsätze / Tungsten Carbide  
Insert Jaws / Твердосплавные вставки



Nadelhalter mit Hartmetalleinlagen  
 Needle Holders with tungsten carbide inserts  
 Porte-aiguilles avec inserts en carbure tungstène  
 Porta-agujas con bocas de carburo tungsteno  
 Иглодержатели с твердосплавной вставкой



**STRATTE**



22,0 cm, 8<sup>5</sup>/<sub>8</sub>"  
 11-26-230-22



23,0 cm, 9"  
 11-26-230-23



**GILLIES**  
 16,0 cm, 6<sup>1</sup>/<sub>4</sub>"  
 11-26-330-16



**OLSEN-HEGAR**



14,0 cm, 5<sup>1</sup>/<sub>2</sub>"  
 11-26-310-14



17,0 cm, 6<sup>3</sup>/<sub>4</sub>"  
 11-26-310-17



18,0 cm, 7"  
 11-26-310-18



**TOENNIS**  
 18,0 cm, 7"  
 11-26-362-18



Nadelhalter mit Hartmetalleinlagen  
Needle Holders with tungsten carbide inserts  
Porte-aiguilles avec inserts en carbure tungstène  
Porta-agujas con bocas de carburo tungsteno  
Иглодержатели с твердосплавной вставкой



MATHIEU-KOCHER



Fig. 1

14,0 cm, 5½"  
11-26-358-14



Fig. 2

17,0 cm, 6¾"  
11-26-358-17

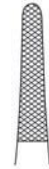

Fig. 3

20,0 cm, 8"  
11-26-358-20



Fig. 4

24,0 cm, 9½"  
11-26-358-24



MATHIEU



Fig. 1

14,0 cm, 5½"  
11-26-350-14



Fig. 2

17,0 cm, 6¾"  
11-26-350-17



Fig. 3

20,0 cm, 8"  
11-26-350-20



Fig. 4

24,0 cm, 9½"  
11-26-350-24

**Nadelhalter mit Hartmetalleinlagen**  
**Needle Holders with tungsten carbide inserts**  
**Porte-aiguilles avec inserts en carbure tungstène**  
**Porta-agujas con bocas de carburo tungsteno**  
**Иглодержатели с твердосплавной вставкой**



**LICHTENBERG**



Fig. 1



Fig. 2



Fig. 3

14,0 cm, 5½"	<b>11-26-366-14</b>	<b>11-26-367-14</b>	<b>11-26-368-14</b>
17,0 cm, 6¾"	<b>11-26-366-17</b>	<b>11-26-367-17</b>	<b>11-26-368-17</b>
20,0 cm, 8"	<b>11-26-366-20</b>	<b>11-26-367-20</b>	<b>11-26-368-20</b>



**MATHIEU**



Fig. 1



Fig. 2



Fig. 3

17,0 cm, 6¾"	<b>11-26-356-17</b>	20,0 cm, 8"	<b>11-26-356-20</b>	23,0 cm, 9"	<b>11-26-356-23</b>
--------------	---------------------	-------------	---------------------	-------------	---------------------

Nadelhalter mit Hartmetalleinlagen  
 Needle Holders with tungsten carbide inserts  
 Porte-aiguilles avec inserts en carbure tungstène  
 Porta-agujas con bocas de carburo tungsteno  
 Иглодержатели с твердосплавной вставкой



ZWEIFEL

20,0 cm, 8"  
11-26-364-20



23,0 cm, 9"  
11-26-364-23



HEPP SCHEIDEL

18,0 cm, 7"  
11-26-390-18



LANGENBECK

18,0 cm, 7"  
11-26-360-18



Fig. 1

20,0 cm, 8"  
11-26-360-20



Fig. 2

23,0 cm, 9"  
11-26-360-23



Fig. 3



**Nadelhalter mit Hartmetalleinlagen**  
**Needle Holders with tungsten carbide inserts**  
**Porte-aiguilles avec inserts en carbure tungstène**  
**Porta-agujas con bocas de carburo tungsteno**  
**Иглодержатели с твердосплавной вставкой**



**CASTROVIEJO**

14,0 cm, 5½"	11-26-570-14	11-26-571-14
18,0 cm, 7"	11-26-570-18	11-26-571-18
22,0 cm, 8¾"	11-26-570-22	11-26-571-22

14,0 cm, 5½"	11-26-576-14	11-26-577-14
18,0 cm, 7"	11-26-576-18	11-26-577-18
22,0 cm, 8¾"	11-26-576-22	11-26-577-22

ohne Sperre  
without ratchet  
sans serrure  
sin cremallera  
без кремальеры



**CASTROVIEJO**

14,0 cm, 5½"	11-26-572-14	11-26-573-14
18,0 cm, 7"	11-26-572-18	11-26-573-18
22,0 cm, 8¾"	11-26-572-22	11-26-573-22

14,0 cm, 5½"	11-26-574-14	11-26-575-14
18,0 cm, 7"	11-26-574-18	11-26-575-18
22,0 cm, 8¾"	11-26-574-22	11-26-575-22

mit Sperre  
with ratchet  
avec serrure  
con cremallera  
с кремальерой



**BARRAQUER**

14,0 cm, 5½"	11-26-560-14	11-26-561-14
18,0 cm, 7"	11-26-560-18	11-26-561-18
21,0 cm, 8¼"	11-26-560-21	11-26-561-21

14,0 cm, 5½"	11-26-562-14	11-26-563-14
18,0 cm, 7"	11-26-562-18	11-26-563-18
21,0 cm, 8¼"	11-26-562-21	11-26-563-21

mit Sperre  
with ratchet  
avec serrure  
con cremallera  
с кремальерой



**BARRAQUER**

14,0 cm, 5½"	11-26-578-14	11-26-579-14
18,0 cm, 7"	11-26-578-18	11-26-579-18

14,0 cm, 5½"	11-26-581-14	11-26-582-14
18,0 cm, 7"	11-26-581-18	11-26-582-18

ohne Sperre  
without ratchet  
sans serrure  
sin cremallera  
без кремальеры





Nadelhalter mit Hartmetalleinlagen  
 Needle Holders with tungsten carbide inserts  
 Porte-aiguilles avec inserts en carbure tungstène  
 Porta-agujas con bocas de carburo tungsteno  
 Иглодержатели с твердосплавной вставкой



**BARRAQUER**

1,8 x 3,4 mm

Hartmetalleinsätze /  
 Tungsten Carbide Insert Jaws\*  
 Твердосплавные вставки

Wolfram-Carbid-Beschichtung /  
 Wolfram Carbide Tip Coating /  
 Покрытие из карбида вольфрама



mit Sperre / with lock / с кремальерой

15 cm / 6"	<b>11-2594-15</b>	<b>11-2598-15</b>	<b>11-2794-15</b>	<b>11-2795-15</b>
18 cm / 7"	<b>11-2594-18</b>	<b>11-2598-18</b>	<b>11-2794-18</b>	<b>11-2795-18</b>

mit Sperre /  
 with lock /  
 с кремальерой

Hartmetalleinsätze\* /  
 Tungsten Carbide Insert Jaws /  
 Твердосплавные вставки



1,3 x 2,0 mm  
**11-2606-20**

Wolfram-Carbid-Beschichtung/  
 Wolfram Carbide Tip Coating /  
 Покрытие из карбида  
 вольфрама



1,2 x 1,8 mm  
**11-2806-20**

mit Sperre /  
 with lock /  
 с кремальерой

Hartmetalleinsätze\* /  
 Tungsten Carbide Insert Jaws /  
 Твердосплавные вставки  
 1,2 x 1,6 mm



14 cm / 5 1/2"	<b>11-1862-14</b>
18 cm / 7"	<b>11-1862-18</b>
21 cm / 8 1/4"	<b>11-1862-21</b>



**BARRAQUER**  
 20 cm / 8"



**CASTROVIEJO-RYDER**

**Nadelhalter mit Hartmetalleinlagen**  
**Needle Holders with tungsten carbide inserts**  
**Porte-aiguilles avec inserts en carbure tungstène**  
**Porta-agujas con bocas de carburo tungsteno**  
**Иглодержатели с твердосплавной вставкой**



**CASTROVIEJO**

mit Sperre  
with ratchet  
avec serrure  
con cremallera  
с кремальерой

Hartmetalleinsätze\* /  
Tungsten Carbide Insert Jaws\* /  
Твердосплавные вставки

1,6 x 2,3 mm



Wolfram-Carbid-Beschichtung /  
Wolfram Carbide Tip Coating /  
Покрытие из карбида вольфрама

1,6 x 2,3 mm



14 cm / 5 1/2"  
18 cm / 7"

**11-1510-14**  
**11-1510-18**

**11-1828-14**  
**11-1828-18**

mit Sperre  
with ratchet  
avec serrure  
con cremallera  
с кремальерой

Hartmetalleinsätze\* /  
Tungsten Carbide Insert Jaws\* /  
Твердосплавные вставки

1,8 x 3,4 mm



Wolfram-Carbid-Beschichtung /  
Wolfram Carbide Tip Coating /  
Покрытие из карбида вольфрама

1,8 x 3,4 mm



14 cm / 5 1/2"  
18 cm / 7"

**11-1864-14**  
**11-1864-18**

**11-1867-14**  
**11-1867-18**

**11-1564-14**  
**11-1564-18**

**11-1567-14**  
**11-1567-18**



**CASTROVIEJO**

Wolfram-Carbid-Beschichtung /  
Wolfram Carbide Tip Coating /  
Покрытие из карбида вольфрама

1,2 x 1,4 mm



18 cm / 7"  
20,5 cm / 8"

**11-1200-18**  
**11-1200-21**

**11-1205-18**  
**11-1205-21**

Glatte Maulteile  
Smooth Jaws /  
Гладкие губки  
1,2 x 1,4 mm



Hartmetalleinsätze\* /  
Tungsten Carbide Insert Jaws\* /  
Твердосплавные вставки  
1,2 x 1,4 mm



18 cm / 7"  
20,5 cm / 8"

**11-1100-18**  
**11-1100-21**

**11-1105-18**  
**11-1105-21**

**11-1500-18**  
**11-1500-21**

**11-1505-18**  
**11-1505-21**

**SPENCER**





REVERDIN-Nadeln  
REVERDIN Needles  
Aiguilles de REVERDIN  
Agujas de REVERDIN  
Иглы лигатурные по Ревердину



REVERDIN



15,0 cm, 6" 11-27-215-01  
19,0 cm, 7½" 11-27-219-01



11-27-215-02  
11-27-219-02



11-27-215-03  
11-27-219-03

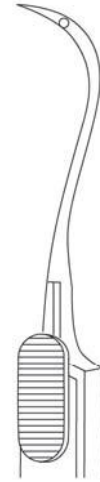

11-27-215-04  
11-27-219-04



REVERDIN

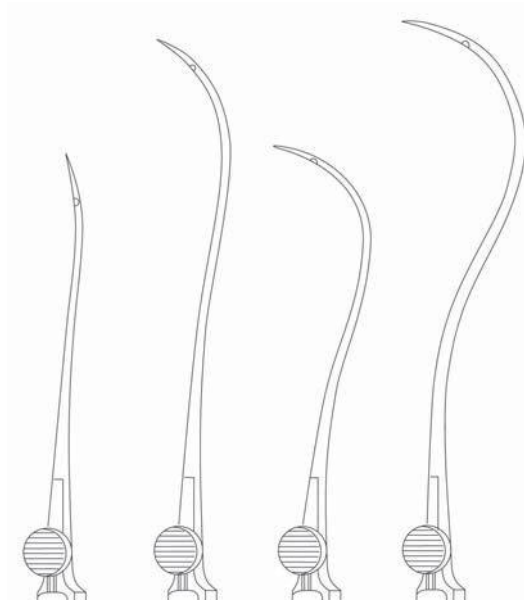

21,0 cm, 8¼" 11-27-221-01 11-27-221-02 11-27-221-03 11-27-221-04  
23,0 cm, 9" 11-27-223-01 11-27-223-02 11-27-223-03 11-27-223-04

Unterbindungsnadeln  
**Ligature Needles**  
**Aiguilles a ligature**  
**Agujas para ligaduras**  
**Иглы лигатурные**



scharf  
 sharp  
 pointu  
 aguda  
 острые

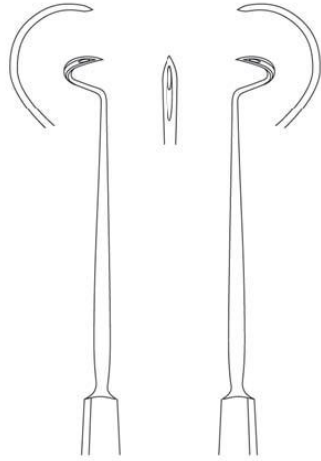

11-27-320-20 11-27-321-20

**DESCHAMPS**  
 20,0 cm, 8"



scharf  
 sharp  
 pointu  
 aguda  
 острые

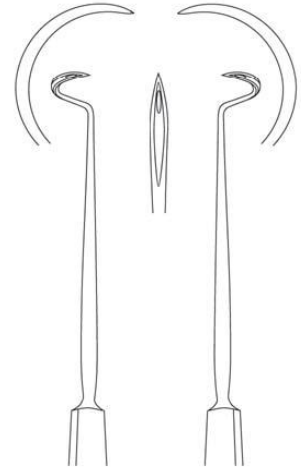

11-27-322-20 11-27-323-20

**DESCHAMPS**  
 20,0 cm, 8"



stumpf  
 blunt  
 mousse  
 roma  
 тупые

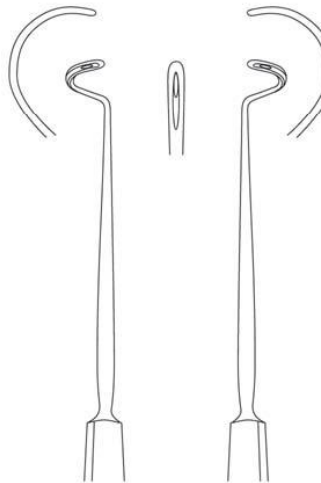

20,0 cm, 8<sup>3</sup>/<sub>4</sub>" 11-27-328-20 11-27-329-20  
 22,5 cm, 8<sup>3</sup>/<sub>4</sub>" 11-27-328-22 11-27-329-22

**DESCHAMPS**



stumpf  
 blunt  
 mousse  
 roma  
 тупые

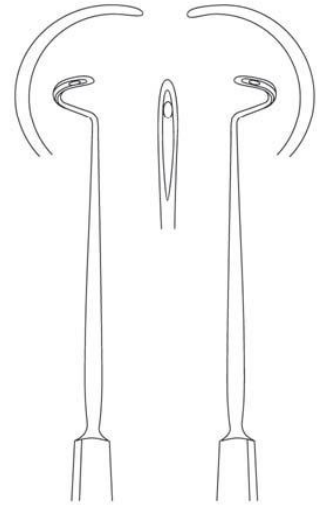

20,0 cm, 8<sup>3</sup>/<sub>4</sub>" 11-27-330-20 11-27-331-20  
 22,5 cm, 8<sup>3</sup>/<sub>4</sub>" 11-27-330-22 11-27-331-22

**DESCHAMPS**

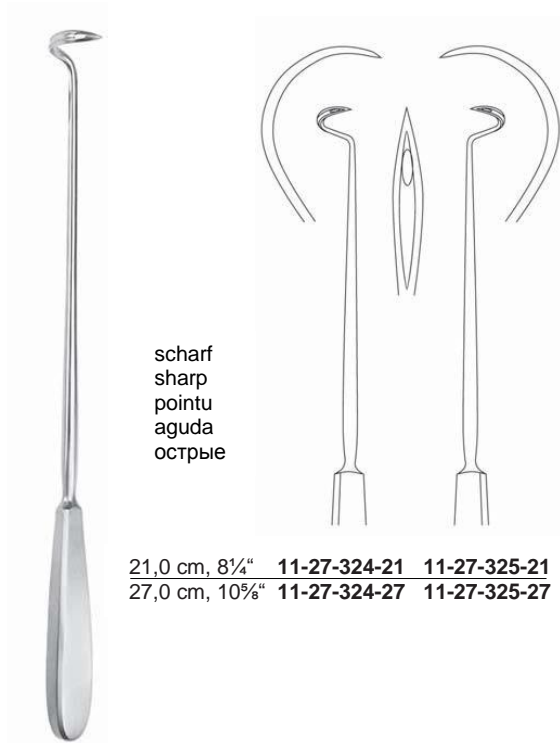

scharf  
sharp  
pointu  
aguda  
острые

21,0 cm, 8¼" 11-27-324-21 11-27-325-21  
27,0 cm, 10⅝" 11-27-324-27 11-27-325-27

DESCHAMPS

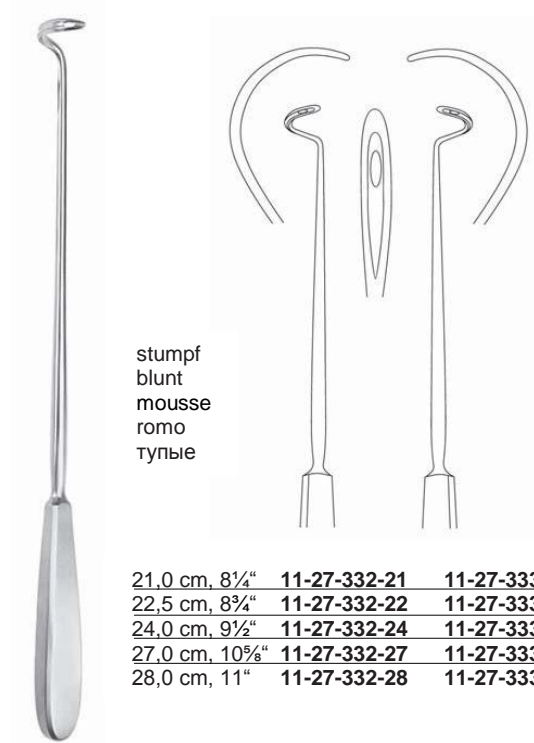

stumpf  
blunt  
mousse  
гомо  
тупые

21,0 cm, 8¼" 11-27-332-21 11-27-333-21  
22,5 cm, 8¾" 11-27-332-22 11-27-333-22  
24,0 cm, 9½" 11-27-332-24 11-27-333-24  
27,0 cm, 10⅝" 11-27-332-27 11-27-333-27  
28,0 cm, 11" 11-27-332-28 11-27-333-28

DESCHAMPS

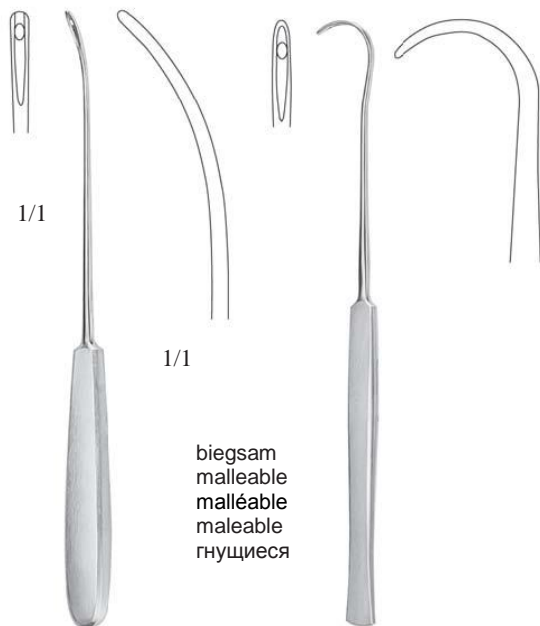

1/1

1/1

biegsam  
malleable  
malleable  
maleable  
гнущиеся

23,0 cm, 9"  
11-27-450-23

COOPER  
19,0 cm, 7½"  
11-27-451-19



COOPER  
20,0 cm, 8"  
11-27-451-20

SYME  
15,0 cm, 6"  
11-27-453-15

**Unterbindungsnadeln**  
**Ligature Needles**  
**Aiguilles a ligature**  
**Agujas para ligaduras**  
**Иглы лигатурные**



**KOCHER**  
 19,0 cm, 7½"



**BRUNNER**  
 25,0 cm, 9¾"



**BRUNNER**  
 30,0 cm, 11¾"

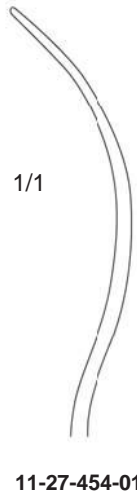

**SCHMIEDEN**  
 21,0 cm, 8¾"



**YOUNG-HRYNTSCHAK**  
24,0 cm, 9½"  
11-27-460-24



Fig. 1

11-27-460-01



Fig. 2

11-27-460-02

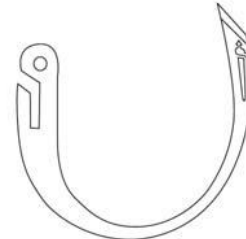

Fig. 3

11-27-460-03



**DE LA ROZA**  
12,0 cm, 4¾"  
11-27-467-01



**DE LA ROZA**  
12,0 cm, 4¾"  
11-27-467-02



**JAKOBI**  
14,0 cm, 5½"  
11-27-469-14



**HESSEBERG**  
15,0 cm, 6"  
11-27-468-15



**KRONECKER**  
13,0 cm, 5"  
11-27-470-01



**KRONECKER**  
13,0 cm, 5"  
11-27-470-02

Unterbindungsnaedeln  
 Ligature Needles  
 Aiguilles a ligature  
 Agujas para ligaduras  
 Иглы лигатурные



**TRELAT**  
 23,0 cm, 9"  
 11-27-472-23



**CLAUS**  
 23,0 cm, 9"  
 11-27-473-23



**HURD**  
 21,0 cm, 8¼"  
 11-27-474-01



**HURD**  
 21,0 cm, 8¼"  
 11-27-474-02



**NAGER**  
 24,0 cm, 9½"  
 11-27-477-24



**CLAUS-EICKEN**  
 23,0 cm, 9"  
 11-27-481-23



**FALK**  
 24,0 cm, 9½"  
 11-27-480-01



**FALK**  
 24,0 cm, 9½"  
 11-27-480-02



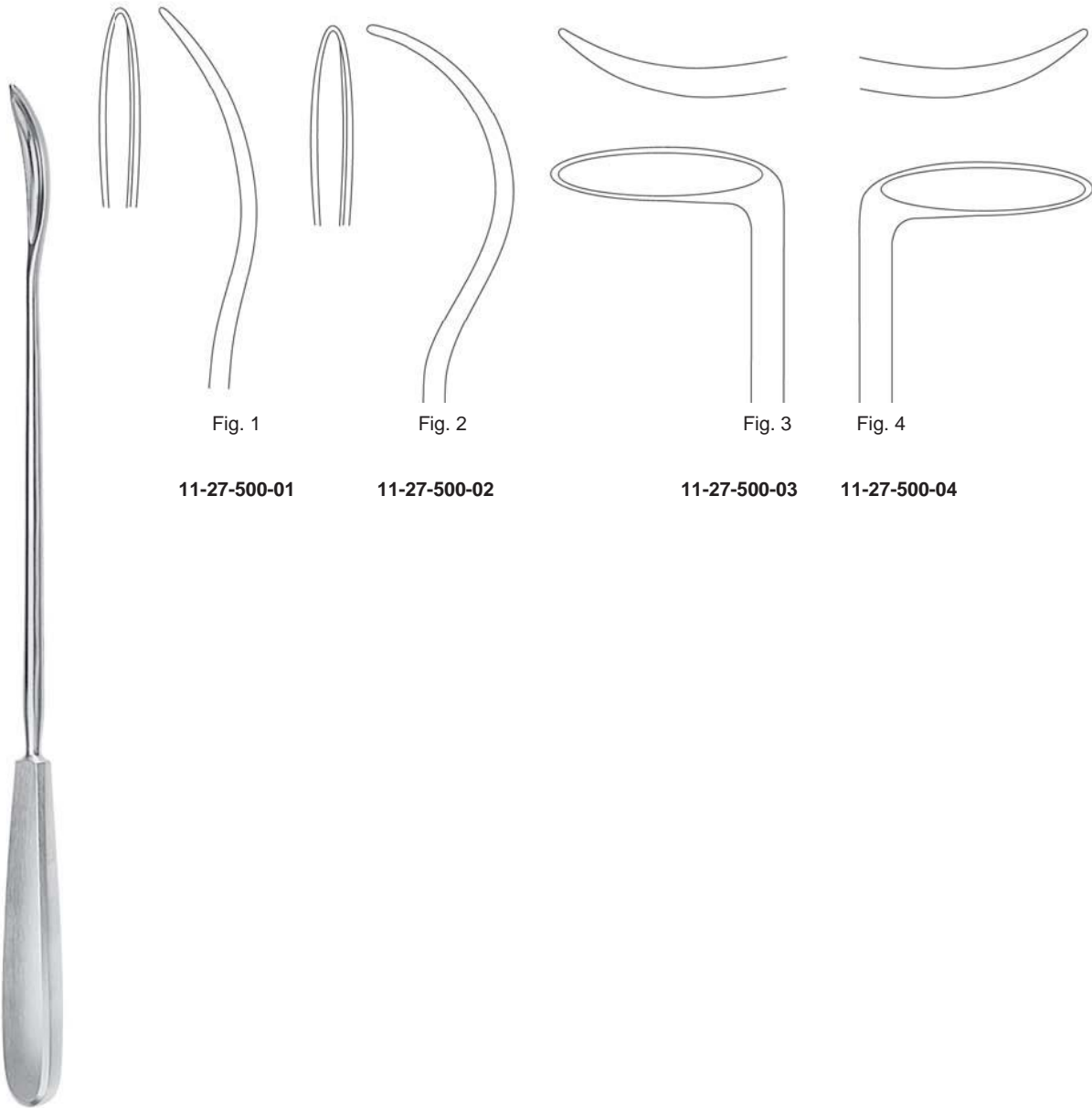

Fig. 1

11-27-500-01

Fig. 2

11-27-500-02

Fig. 3

11-27-500-03

Fig. 4

11-27-500-04

**BRUNNER**  
30,0 cm, 11¾"

Führungshohlsonden  
 Ligature Conductors  
 Sondes conductrices  
 Sondas conductoras  
 Направляющие лигатур



**PAYR**  
 22,0 cm, 8<sup>5</sup>/<sub>8</sub>"  
 11-27-502-22



**PAYR**  
 22,0 cm, 8<sup>5</sup>/<sub>8</sub>"  
 11-27-503-22

mit Loch  
 with hole  
 avec perforateur  
 con foro  
 с отверстием



**SCHMIEDEN-PAYR**  
 19,0 cm, 7<sup>1</sup>/<sub>2</sub>"  
 11-27-506-19

ohne Loch  
 without hole  
 sans perforateur  
 sin foro  
 без отверстия



**SCHMIEDEN**  
 19,0 cm, 7<sup>1</sup>/<sub>2</sub>"  
 11-27-507-19



**KÖNIG**  
 19,5 cm, 7<sup>3</sup>/<sub>4</sub>"  
 11-27-508-03



**KÖNIG**  
 19,5 cm, 7<sup>3</sup>/<sub>4</sub>"  
 11-27-508-05



**KÖNIG**  
 19,5 cm, 7<sup>3</sup>/<sub>4</sub>"  
 11-27-508-07



KIRSCHNER

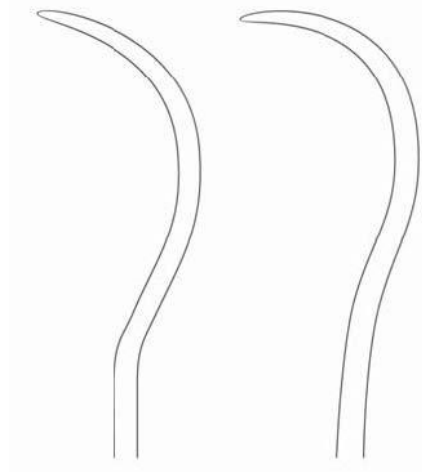

25,5 cm, 10"  
11-27-510-25

28,0 cm, 11"  
11-27-510-28



BRUNNER-FERROZELL  
18,0 cm, 7" 11-27-521-18  
27,0 cm, 10<sup>5</sup>/<sub>8</sub>" 11-27-521-27



KOCHER

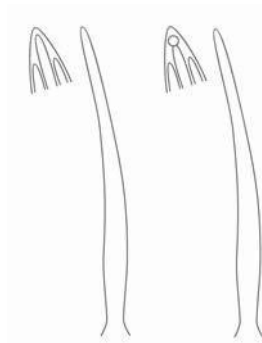

15,0 cm, 6" 11-27-513-15 11-27-514-15  
16,0 cm, 6<sup>1</sup>/<sub>4</sub>" 11-27-513-16 11-27-514-16

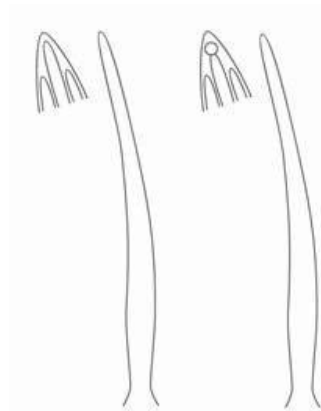

18,0 cm, 7" 11-27-515-18  
18,0 cm, 7" 11-27-516-18

Nahtinstrumente  
 Suture Instruments  
 Instruments a suture  
 Instrumentos para sutura  
 Шовные инструменты



**MOD. WIEN**  
 23,5 cm, 9¼"  
 11-27-532-23



**BOZEMANN**  
 21,0 cm, 8¼"  
 11-27-531-21



23,0 cm, 9"  
 11-27-530-23



**MICHEL**  
 12,0 cm, 4¾"  
 11-27-550-12



**COLLIN**  
 13,0 cm, 5"  
 11-27-552-13



**RICHTER-HEATH**  
 14,0 cm, 5½"  
 11-27-553-14



**WACHENFELDT**  
 12,5 cm, 5"  
 11-27-555-01



**HEGENBARTH**  
 12,5 cm, 5"  
 11-27-556-12



**MICHEL**  
12,0 cm, 4 3/4"  
11-27-558-12



**LANGE**  
10,0 cm, 4"  
11-27-559-10



**CHILDE**  
18,0 cm, 7"  
11-27-560-01



**CHILDE**  
18,0 cm, 7"  
11-27-560-02

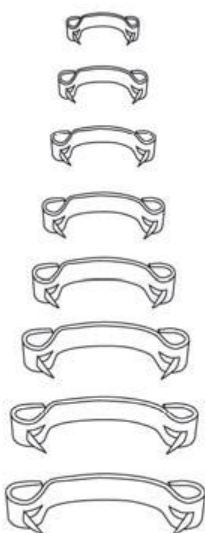

- 11-27-570-08 7,5 x 1,75 mm
- 11-27-570-11 11,0 x 2,0 mm
- 11-27-570-12 12,0 x 3,0 mm
- 11-27-570-14 14,0 x 3,0 mm
- 11-27-570-16 16,0 x 3,0 mm
- 11-27-570-18 18,0 x 3,0 mm
- 11-27-570-20 20,0 x 3,0 mm
- 11-27-570-22 22,0 x 3,0 mm



**CLIP-SET**  
11-27-558-00

bestehend aus, consisting of, consisten en,  
compuesto de, состоит из:

- 1 x 11-27-558-12
- 1 x 11-27-550-12
- 50 x 11-27-570-14
- 1 x 11-27-590-01 (Etui)

**Mikro-Nadelhalter**  
**Micro Needle Holders**  
**Porte-aiguilles micro**  
**Micro Porta-agujas**  
**Микро-иглодержатели**







Mikro-Nadelhalter  
Micro Needle Holders  
Porte-aiguilles micro  
Micro Porta-agujas  
Микро-иглодержатели



11-25-553-11 11-25-553-13

ohne Sperre  
without ratchet  
sans serrure  
sin cremallera  
без кремальеры

**BARRAQUER**  
10,0 cm, 4"



11-25-550-10 11-25-551-10

ohne Sperre  
without ratchet  
sans serrure  
sin cremallera  
без кремальеры

**BARRAQUER-TROUTMAN**  
10,0 cm, 4"



mit Sperre  
with ratchet  
avec serrure  
con cremallera  
с кремальерой

**BARRAQUER**  
13,5 cm, 5 1/4"  
11-25-621-13



ohne Sperre  
without ratchet  
sans serrure  
sin cremallera  
без кремальеры

**GOMEL**  
14,0 cm, 5 1/2"  
11-25-601-14



**Mikro-Nadelhalter  
Micro Needle Holders  
Porte-aiguilles micro  
Micro Porta-agujas  
Микро-иглодержатели**



18,5 cm, 7¼"



ohne Sperre  
without ratchet  
sans serrure  
sin cremallera  
без кремальеры



18,5 cm, 7¼"



mit Sperre  
with ratchet  
avec serrure  
con cremallera  
с кремальерой



**CASTROVIEJO**

ohne Sperre  
without ratchet  
sans serrure  
sin cremallera,  
без кремальеры



9,0 cm, 3½"	<b>11-25-570-09</b>	<b>11-25-571-09</b>
14,0 cm, 5½"	<b>11-25-570-14</b>	<b>11-25-571-14</b>
18,0 cm, 7"	<b>11-25-570-18</b>	<b>11-25-571-18</b>

mit Sperre,  
with ratchet  
avec serrure  
con cremallera,  
с кремальерой



9,0 cm, 3½"	<b>11-25-576-09</b>	<b>11-25-577-09</b>
14,0 cm, 5½"	<b>11-25-576-14</b>	<b>11-25-577-14</b>
18,0 cm, 7"	<b>11-25-576-18</b>	<b>11-25-577-18</b>



**Mikro-Nadelhalter**  
**Micro Needle Holders**  
**Porte-aiguilles micro**  
**Micro Porta-agujas**  
**Микро-иглодержатели**

0,4 mm



gerade, ohne Sperre  
straight, without ratchet  
droit, sans serrure  
recta, sin cremallera  
прямые, без кремальеры

14,0 cm, 5½"  
11-25-650-14

0,4 mm



gebogen, ohne Sperre  
curved, without ratchet  
courbe, sans serrure  
curva, sin cremallera  
изогнутые, без кремальеры

14,0 cm, 5½"  
11-25-651-14

0,4 mm



gebogen, mit Sperre  
curved, with ratchet  
courbe, avec serrure  
curva, con cremallera  
изогнутые, с кремальерой

14,0 cm, 5½"  
11-25-653-14

0,5 mm



gebogen, ohne Sperre  
curved, without ratchet  
courbe, sans serrure  
curva, sin cremallera  
изогнутые, без кремальеры

Ø 8 mm

14,0 cm, 5½"  
11-25-663-14

0,4 mm



gebogen, ohne Sperre  
curved, without ratchet  
courbe, sans serrure  
curva, sin cremallera  
изогнутые, без кремальеры

Ø 8 mm

13,0 cm, 5"  
11-25-673-13

**Mikro-Nadelhalter  
Micro Needle Holders  
Porte-aiguilles micro  
Micro Porta-agujas  
Микро-иглодержатели**



**MICRO-CASTROVIEJO**  
9 cm / 3 1/2"

Glatte Maulteile  
Mooth Jaws /  
Гладкие губки



DELICATE

ohne Sperre  
without ratchet  
sans serrure  
sin cremallera  
без кремальеры

0,75 x 1,0 mm    **11-1120-09**    **11-1125-09**

MICRO

0,5 x 0,75 mm    **11-1121-09**    **11-1126-09**

mit Sperre  
with ratchet  
avec serrure  
con cremallera  
с кремальерой

DELICATE

0,75 x 1,0 mm    **11-1122-09**    **11-1127-09**

MICRO

0,5 x 0,75 mm    **11-1123-09**    **11-1128-09**

Glatte Maulteile /  
Smooth Jaws /  
Гладкие губки

Wolfram-Carbid-Beschichtung /  
Wolfram Carbide Tip Coating /  
Покрытие из карбида вольфрама



ohne Sperre  
without ratchet  
sans serrure  
sin cremallera  
без кремальеры

DELICATE

0,75 x 1,0 mm    **11-1120-14**    **11-1125-14**    **11-1180-14**    **11.1185.14**

MICRO

0,5 x 0,75 mm    **11-1121-14**    **11-1126-14**    **11-1181-14**    **11-1186-14**

mit Sperre,  
with ratchet  
avec serrure  
con cremallera  
с кремальерой

DELICATE

0,75 x 1,0 m    **11-1122-14**    **11-1127-14**    **11-1182-14**    **11-1187-14**

MICRO

0,5 x 0,75 m    **11-1123-14**    **11-1128-14**    **11-1183-14**    **11-1188-14**



**CASTROVIEJO**  
14 cm / 5 1/2"



Glatte Maulteile /  
Smooth Jaws /  
Гладкие губки

Hartmetalleinsätze /  
Tungsten Carbide Insert Jaws /  
Твердосплавные вставки

1,2 x 1,6 mm

1,6 x 2,3 mm



ohne Sperre  
without ratchet  
sans serrure  
sin cremallera  
без кремальеры

14 cm / 5 1/2"	11-1130-14	11-1135-14	11-1840-14	11-1845-14
18 cm / 7"	11-1150-18	11-1155-18	11-1870-18	11-1875-18
21 cm / 8 1/4"	11-1150-21	11-1155-21	11-1870-21	11-1875-21

mit Sperre  
with ratchet  
avec serrure  
con cremallera  
с кремальерой

14 cm / 5 1/2"	11-1140-14	11-1145-14	11-1830-14	11-1835-14
18 cm / 7"	11-1160-18	11-1165-18	11-1860-18	11-1865-18
21 cm / 8 1/4"	11-1160-21	11-1165-21	11-1860-21	11-1865-21

Wolfram-Carbid-Beschichtung /  
Wolfram Carbide Tip Coating /  
Покрытие из карбида вольфрама

Maul gerieft /  
Jaws serrated /  
Губки рифленные

1,2 x 1,6 mm

1,2 x 1,6 mm



ohne Sperre  
without ratchet  
sans serrure  
sin cremallera  
без кремальеры

14 cm / 5 1/2"	11-1152-14	11-1157-14	11-1134-14	11-1139-14
18 cm / 7"	11-1152-18	11-1157-18	11-1154-18	11-1159-18
21 cm / 8 1/4"	11-1152-21	11-1157-21	11-1154-21	11-1159-21

mit Sperre,  
with ratchet  
avec serrure  
con cremallera  
с кремальерой

14 cm / 5 1/2"	11-1162-14	11-1167-14	11-1144-14	11-1149-14
18 cm / 7"	11-1162-18	11-1167-18	11-1144-18	11-1149-18
21 cm / 8 1/4"	11-1162-21	11-1167-21	11-1144-21	11-1149-21



CASTROVIEJO

**Mikro-Nadelhalter  
Micro Needle Holders  
Porte-aiguilles micro  
Micro Porta-agujas  
Микро-иглодержатели**

**Nadelhalter mit getauchten Kehlen  
Needle Holder with special handle finish  
Иглодержатель со специальной конечной частью ручек**



**CASTROVIEJO**

ohne Sperre  
without ratchet  
sans serrure  
sin cremallera  
без кремальеры

mit Sperre  
with ratchet  
avec serrure  
con cremallera  
с кремальерой

ohne Sperre  
without ratchet  
sans serrure  
sin cremallera  
без кремальеры

mit Sperre  
with ratchet  
avec serrure  
con cremallera  
с кремальерой

Glatte Maulteile /  
Smooth Jaws /  
Гладкие губки

1,2 x 1,6 mm



Hartmetalleinsätze /  
Tungsten Carbide Insert Jaws /  
Твердосплавные вставки

1,6 x 2,3 mm



14 cm / 5 1/2"  
18 cm / 7"

11-1130-14-R  
11-1130-18-R

11-1135-14-R  
11-1135-18-R

11-1830-14-R  
11-1830-18-R

11-1835-14-R  
11-1835-18-R

14 cm / 5 1/2"  
18 cm / 7"

11-1140-14-R  
11-1140-18-R

11-1145-14-R  
11-1145-8-R

11-1840-14-R  
11-1840-18-R

11-1845-14-R  
11-1845-18-R

Wolfram-Carbid-Beschichtung /  
Wolfram Carbide Tip Coating /  
Покрытие из карбида вольфрама

1,2 x 1,6 mm



14 cm / 5 1/2"  
18 cm / 7"

11-1152-14-R  
11-1152-18-R

11-1157-14-R  
11-1157-18-R

14 cm / 5 1/2"  
18 cm / 7"

11-1162-14-R  
11-1162-18-R

11-1167-14-R  
11-1167-18-R

Glatte Maulteile /  
Smooth Jaws /  
Гладкие губки

0,9 x 1,3 mm



Hartmetalleinsätze / Tungsten  
Carbide Insert Jaws /  
Твердосплавные вставки

1,2 x 1,8 mm



Wolfram-Carbid-Beschichtung /  
Wolfram Carbide Tip Coating /  
Покрытие из карбида вольфрама

0,9 x 1,3 mm



ohne Sperre  
without ratchet  
sans serrure  
sin cremallera  
без кремальеры

11-1172-17

11-1175-17

11-1872-17

11-1875-17

11-1192-17

11-1195-17

mit Sperre  
with ratchet  
avec serrure  
con cremallera  
с кремальерой

11-1170-17

11-1173-17

11-1870-17

11-1873-17

11-1190-17

11-1193-17



Wolfram-Carbid-Beschichtung /  
Wolfram Carbide Tip Coating /  
Покрытие из карбида вольфрама



ohne Sperre  
without ratchet  
sans serrure  
sin cremallera  
без кремальеры

	DELICATE	
12 x 1,2 x 1,6 mm	11-2880-14T	11-2885-14T
14 cm / 5 1/2"	11-2880-18T	11-2885-18T
18 cm / 7"	11-2880-21T	11-2885-21T
21 cm / 8 1/4"	11-2880-23T	11-2885-23T

	MICRO	
12 x 0,8 x 1,2 mm	11-2882-14T	11-2887-14T
14 cm / 5 1/2"	11-2882-18T	11-2887-18T
18 cm / 7"	11-2882-21T	11-2887-21T
21 cm / 8 1/4"	11-2882-23T	11-2887-23T

mit Sperre  
with ratchet  
avec serrure  
con cremallera  
с кремальерой

	DELICATE	
12 x 1,2 x 1,6 mm	11-2890-14T	11-2895-14T
14 cm / 5 1/2"	11-2890-18T	11-2895-18T
18 cm / 7"	11-2890-21T	11-2895-21T
21 cm / 8 1/4"	11-2890-23T	11-2895-23T

	MICRO	
12 x 0,8 x 1,2 mm	11-2892-14T	11-2897-14T
14 cm / 5 1/2"	11-2892-18T	11-2897-18T
18 cm / 7"	11-2892-21T	11-2897-21T
21 cm / 8 1/4"	11-2892-23T	11-2897-23T



**TOLEDO**

Glatte Maulteile /  
Smooth Jaws /  
Гладкие губки

Hartmetalleinsätze /  
Tungsten Carbide Insert Jaws  
Твердосплавные вставки



ohne Sperre  
without ratchet  
sans serrure  
sin cremallera  
без кремальеры

	DELICATE 12 x 1,2 x 1,6 mm		DELICATE 12 x 1,2 x 2,0 mm	
14 cm / 5 1/2"	11-2280-14T	11-2285-14T	11-2520-14T	11-2525-14T
18 cm / 7"	11-2280-18T	11-2285-18T	11-2580-18T	11-2585-18T
21 cm / 8 1/4"	11-2280-21T	11-2285-21T	11-2580-21T	11-2585-21T
23 cm / 9"	11-2280-23T	11-2285-23T	11-2580-23T	11-2585-23T

	MICRO 12 x 0,8 x 1,2 mm		MICRO 12 x 1,0 x 1,8 mm	
14 cm / 5 1/2"	11-2282-14T	11-2287-14T	11-2522-14T	11-2527-14T
18 cm / 7"	11-2282-18T	11-2287-18T	11-2582-18T	11-2587-18T
21 cm / 8 1/4"	11-2282-21T	11-2287-21T	11-2582-21T	11-2587-21T
23 cm / 9"	11-2282-23T	11-2287-23T	11-2582-23T	11-2587-23T

mit Sperre,  
with ratchet  
avec serrure  
con cremallera  
с кремальерой

	DELICATE 12 x 1,2 x 1,6 mm		DELICATE 12 x 1,2 x 2,0 mm	
14 cm / 5 1/2"	11-2290-14T	11-2295-14T	11-2510-14T	11-2515-14T
18 cm / 7"	11-2290-18T	11-2295-18T	11-2590-18T	11-2595-18T
21 cm / 8 1/4"	11-2290-21T	11-2295-21T	11-2590-21T	11-2595-21T
23 cm / 9"	11-2290-23T	11-2295-23T	11-2590-23T	11-2595-23T

	MICRO 12 x 0,8 x 1,2 mm		MICRO 12 x 1,0 x 1,8 mm	
14 cm / 5 1/2"	11-2292-14T	11-2297-14T	11-2512-14T	11-2517-14T
18 cm / 7"	11-2292-18T	11-2297-18T	11-2592-18T	11-2597-18T
21 cm / 8 1/4"	11-2292-21T	11-2297-21T	11-2592-21T	11-2597-21T
23 cm / 9"	11-2292-23T	11-2297-23T	11-2592-23T	11-2597-23T

**Mikro-Nadelhalter  
Micro Needle Holders  
Porte-aiguilles micro  
Micro Porta-agujas  
Микро-иглодержатели**



**BARRAQUER**  
14 cm / 5 1/2"

ohne Sperre  
without ratchet  
sans serrure  
sin cremallera  
без кремальеры

mit Sperre,  
with ratchet  
avec serrure  
con cremallera  
с кремальерой

DELICATE  
1,2 x 1,6 mm  
MICRO  
0,8 x 1,2 mm

Glatte Maulteile /  
Smooth Jaws /  
Гладкие губки

Wolfram-Carbid-Beschichtung /  
Wolfram Carbide Tip Coating /  
Покрытие из карбида вольфрама



11-2270-14 11-2273-14 11-2821-14 11-2829-14

11-2170-14 11-2173-14 11-2848-14 11-2849-14

11-2272-14 11-2275-14 11-2824-14 11-2825-14

11-2172-14 11-2175-14 11-2844-14 11-2845-14

Glatte Maulteile /  
Smooth Jaws /  
Гладкие губки

Wolfram-Carbid-Beschichtung /  
Wolfram Carbide Tip Coating /  
Покрытие из карбида вольфрама



ohne Sperre  
without ratchet  
sans serrure  
sin cremallera  
без кремальеры

DELICATE  
1,2 x 1,6 mm  
MICRO  
0,8 x 1,2 mm

11-2135-16 11-2137-16 11-2835-16 11-2837-16

11-2125-16 11-2127-16 11-2825-16 11-2827-16

mit Sperre  
with ratchet  
avec serrure  
con cremallera  
с кремальерой

DELICATE  
1,2 x 1,6 mm  
MICRO  
0,8 x 1,2 mm

11-2131-16 11-2133-16 11-2831-16 11-2833-16

11-2121-16 11-2123-16 11-2821-16 11-2823-16



**BARRAQUER**  
16 cm / 6 1/4"

**Mikro-Nadelhalter  
Micro Needle Holders  
Porte-aiguilles micro  
Micro Porta-agujas  
Микро-иглодержатели**



**BARRAQUER**

ohne Sperre  
without ratchet  
sans serrure  
sin cremallera  
без кремальеры

mit Sperre  
with ratchet  
avec serrure  
con cremallera  
с кремальерой

Glatte Maulteile /  
Smooth Jaws /  
Гладкие губки

Wolfram-Carbid-Beschichtung /  
Wolfram Carbide Tip Coating /  
Покрытие из карбида вольфрама

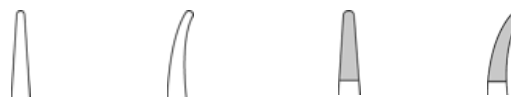

	0,75 x 1,0 mm		0,75 x 1,0 mm	
DELICATE				
12 cm / 4 3/4"	11-2200-12	11-2205-12	11-2800-12	11-2805-12
15 cm / 6"	11-2360-15	11-2365-15	11-2860-15	11-2865-15
18 cm / 7"	11-2360-18	11-2365-18	11-2860-18	11-2865-18
MICRO	0,5 x 0,75 mm		0,5 x 0,75 mm	
12 cm / 4 3/4"	11-2201-12	11-2206-12	11-2801-12	11-2806-12
15 cm / 6"	11-2382-15	11-2387-15	11-2982-15	11-2987-15
18 cm / 7"	11-2382-18	11-2387-18	11-2982-18	11-2987-18
	0,75 x 1,0 m		0,75 x 1,0 mm	
DELICATE				
12 cm / 4 3/4"	11-2210-12	11-2215-12	11-2810-12	11-2815-12
15 cm / 6"	11-2370-15	11-2375-15	11-2870-15	11-2875-15
18 cm / 7"	11-2370-18	11-2375-18	11-2870-18	11-2875-18
MICRO	0,5 x 0,75 m		0,5 x 0,75 mm	
12 cm / 4 3/4"	11-2211-12	11-2216-12	11-2811-12	11-2816-12
15 cm / 6"	11-2392-15	11-2397-15	11-2992-15	11-2997-15
18 cm / 7"	11-2392-18	11-2397-18	11-2992-18	11-2997-18

Wolfram-Carbid-Beschichtung /  
Wolfram Carbide Tip Coating /  
Покрытие из карбида вольфрама



1,2 x 1,8 mm  
ohne Sperre / without lock / без кремальеры  
**11-2630-23 11-2631-23**  
mit Sperre / with lock / с кремальерой  
**11-2628-23 11-2629-23**

Glatte Maulteile /  
Smooth Jaws /  
Гладкие губки

Hartmetalleinsätze /  
Tungsten Carbide Insert Jaws /  
Твердосплавные вставки

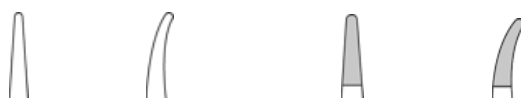

1,2 x 1,8 mm  
ohne Sperre / without lock / без кремальеры  
**11-2230-23 11-2231-23 11-2530-23 11-2532-23**  
mit Sperre / with lock / с кремальерой  
**11-2228-23 11-2229-23 11-2528-23 11-2529-23**



**BARRAQUER**  
23 cm / 9"



**Mikro-Nadelhalter  
Micro Needle Holders  
Porte-aiguilles micro  
Micro Porta-agujas  
Микро-иглодержатели**



**BARRAQUER**

ohne Sperre  
without ratchet  
sans serrure  
sin cremallera  
без кремальеры

Wolfram-Carbid-Beschichtung /  
Wolfram Carbide Tip Coating /  
Покрытие из карбида вольфрама



	1,2 x 1,6 mm	
DELICATE		
14 cm / 5 1/2"	11-2880-14	11-2885-14
15 cm / 6"	11-2880-15	11-2885-15
18 cm / 7"	11-2880-18	11-2885-18
21 cm / 8 1/4"	11-2880-21	11-2885-21
23 cm / 9"	11-2880-23	11-2885-23

	0,8 x 1,2 mm	
MICRO		
14 cm / 5 1/2"	11-2882-14	11-2887-14
15 cm / 6"	11-2882-15	11-2887-15
18 cm / 7"	11-2882-18	11-2887-18
21 cm / 8 1/4"	11-2882-21	11-2887-21
23 cm / 9"	11-2882-23	11-2887-23

Glatte Maulteile /  
Smooth Jaws /  
Гладкие губки

Hartmetalleinsätze /  
Tungsten Carbide Insert Jaws /  
Твердосплавные вставки \*



	1,2 x 1,6 mm		1,3 x 2,0 mm	
DELICATE				
14 cm / 5 1/2"	11-2280-14	11-2285-14	11-2520-14	11-2525-14
15 cm / 6"	11-2280-15	11-2285-15	11-2580-15	11-2585-15
18 cm / 7"	11-2280-18	11-2285-18	11-2580-15	11-2585-18
21 cm / 8 1/4"	11-2280-21	11-2285-21	11-2580-21	11-2585-21
23 cm / 9"	11-2280-23	11-2285-23	11-2580-23	11-2585-23

ohne Sperre  
without ratchet  
sans serrure  
sin cremallera  
без кремальеры

	0,8 x 1,2 mm		1,0 x 1,8 mm	
MICRO				
14 cm / 5 1/2"	11-2282-14	11-2287-14	11-2522-14	11-2527-14
15 cm / 6"	11-2282-15	11-2287-15	11-2582-15	11-2587-15
18 cm / 7"	11-2282-18	11-2287-18	11-2582-15	11-2587-18
21 cm / 8 1/4"	11-2282-21	11-2287-21	11-2582-21	11-2587-21
23 cm / 9"	11-2282-23	11-2287-23	11-2582-23	11-2587-23



BARRAQUER

mit Sperre  
with ratchet  
avec serrure  
con cremallera  
с кремальерой

Wolfram-Carbid-Beschichtung /  
Wolfram Carbide Tip Coating /  
Покрытие из карбида вольфрама



DELICATE		1,2 x 1,6 mm	
14 cm / 5 1/2"	11-2890-14	11-2895-14	
15 cm / 6"	11-2890-15	11-2895-15	
18 cm / 7"	11-2890-18	11-2895-18	
21 cm / 8 1/4"	11-2890-21	11-2895-21	
23 cm / 9"	11-2890-23	11-2895-23	

MICRO		0,8 x 1,2 mm	
14 cm / 5 1/2"	11-2892-14	11-2897-14	
15 cm / 6"	11-2892-15	11-2897-15	
18 cm / 7"	11-2892-18	11-2897-18	
21 cm / 8 1/4"	11-2892-21	11-2897-21	
23 cm / 9"	11-2892-23	11-2897-23	

Glatte Maulteile /  
Smooth Jaws /  
Гладкие губки

Hartmetalleinsätze /  
Tungsten Carbide Insert Jaws\* /  
Твердосплавные вставки



mit Sperre  
with ratchet  
avec serrure  
con cremallera  
с кремальерой

DELICATE		1,2 x 1,6 mm		1,3 x 2,0 mm	
14 cm / 5 1/2"	11-2290-14	11-2295-14	11-2510-14	11-2515-14	
15 cm / 6"	11-2290-15	11-2295-15	11-2590-15	11-2595-15	
18 cm / 7"	11-2290-18	11-2295-18	11-2590-15	11-2595-18	
21 cm / 8 1/4"	11-2290-21	11-2295-21	11-2590-21	11-2595-21	
23 cm / 9"	11-2290-23	11-2295-23	11-2590-23	11-2595-23	

MICRO		0,8 x 1,2 mm		1,0 x 1,8 mm	
14 cm / 5 1/2"	11-2292-14	11-2297-14	11-2512-14	11-2517-14	
15 cm / 6"	11-2292-15	11-2297-15	11-2592-15	11-2597-15	
18 cm / 7"	11-2292-18	11-2297-18	11-2592-15	11-2597-18	
21 cm / 8 1/4"	11-2292-21	11-2297-21	11-2592-21	11-2597-21	
23 cm / 9"	11-2292-23	11-2297-23	11-2592-23	11-2597-23	

**Mikro-Nadelhalter  
Micro Needle Holders  
Porte-aiguilles micro  
Micro Porta-agujas  
Микро-иглодержатели**

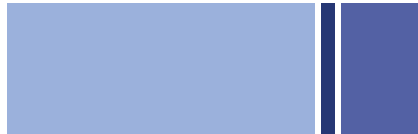

Wolfram-Carbid-Beschichtung /  
Wolfram Carbide Tip Coating /  
Покрытие из карбида вольфрама  
1,2 x 1,8 mm



ohne Sperre / without lock / без кремальеры		
18 cm / 7"	<b>11-2886-18</b>	<b>11-2881-18</b>
21 cm / 8 1/4"	<b>11-2886-21</b>	<b>11-2881-21</b>
mit Sperre / with lock / с кремальерой		
18 cm / 7"	<b>11-2896-18</b>	<b>11-2891-18</b>
21 cm / 8 1/4"	<b>11-2896-21</b>	<b>11-2891-21</b>

Glatte Maulteile /  
Smooth Jaws /  
Гладкие губки

Hartmetalleinsätze /  
Tungsten Carbide Insert Jaws\* /  
Твердосплавные вставки



1,2 x 1,8 mm

1,3 x 2,0 mm

ohne Sperre / without lock / без кремальеры				
18 cm / 7"	<b>11-2276-18</b>	<b>11-2271-18</b>	<b>11-2576-18</b>	<b>11-2579-18</b>
21 cm / 8 1/4"	<b>11-2276-21</b>	<b>11-2271-21</b>	<b>11-2576-21</b>	<b>11-2579-21</b>
mit Sperre / with lock / с кремальерой				
18 cm / 7"	<b>11-2296-18</b>	<b>11-2291-18</b>	<b>11-2567-18</b>	<b>11-2569-18</b>
21 cm / 8 1/4"	<b>11-2296-21</b>	<b>11-2291-21</b>	<b>11-2567-21</b>	<b>11-2569-21</b>



**BARRAQUER**



**BARRAQUER**

Wolfram-Carbid-Beschichtung /  
Wolfram Carbide Tip Coating /  
Покрытие из карбида вольфрама  
2,0 x 3,0 mm



ohne Sperre / without lock / без кремальеры		
19 cm / 7 1/2"	<b>11-2804-19</b>	<b>11-2807-19</b>
23 cm / 9"	<b>11-2804-23</b>	<b>11-2807-23</b>
25 cm / 9 3/4"	<b>11-2804-25</b>	<b>11-2807-25</b>
mit Sperre / with lock / с кремальерой		
19 cm / 7 1/2"	<b>11-2806-19</b>	<b>11-2808-19</b>
23 cm / 9"	<b>11-2806-23</b>	<b>11-2808-23</b>
25 cm / 9 3/4"	<b>11-2806-25</b>	<b>11-2808-25</b>

Glatte Maulteile /  
Smooth Jaws /  
Гладкие губки

Hartmetalleinsätze /  
Tungsten Carbide Insert Jaws\* /  
Твердосплавные вставки

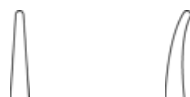

2,0 x 3,0 mm

ohne Sperre / without lock / без кремальеры				
19 cm / 7 1/2"	<b>11-2203-19</b>	<b>11-2205-19</b>	<b>11-2604-19</b>	<b>11-2605-19</b>
23 cm / 9"	<b>11-2203-23</b>	<b>11-2205-23</b>	<b>11-2604-23</b>	<b>11-2605-23</b>
25 cm / 9 3/4"	<b>11-2203-25</b>	<b>11-2205-25</b>	<b>11-2604-25</b>	<b>11-2605-25</b>
mit Sperre / with lock / с кремальерой				
19 cm / 7 1/2"	<b>11-2202-19</b>	<b>11-2201-19</b>	<b>11-2606-19</b>	<b>11-2607-19</b>
23 cm / 9"	<b>11-2202-23</b>	<b>11-2201-23</b>	<b>11-2606-23</b>	<b>11-2607-23</b>
25 cm / 9 3/4"	<b>11-2202-25</b>	<b>11-2201-25</b>	<b>11-2606-25</b>	<b>11-2607-25</b>

**Mikro-Nadelhalter**  
**Micro Needle Holders**  
**Porte-aiguilles micro**  
**Micro Porta-agujas**  
**Микро-иглодержатели**



**BARRAQUER**

Glatte Maulteile /  
 Smooth Jaws /  
 Гладкие губки



Wolfram-Carbid-Beschichtung /  
 Wolfram Carbide Tip Coating /  
 Покрытие из карбида вольфрама

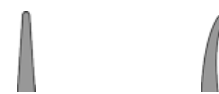

		ohne Sperre / without lock / без кремальеры		ohne Sperre / without lock / без кремальеры	
		0,4 x 1,1 mm		0,4 x 1,1 mm	
15 cm / 6"	<b>11-2450-15</b>	<b>11-2455-15</b>	<b>11-2950-15</b>	<b>11-2955-15</b>	
18 cm / 7"	<b>11-2450-18</b>	<b>11-2455-18</b>	<b>11-2950-18</b>	<b>11-2955-18</b>	
21 cm / 8 1/4"	<b>11-2450-21</b>	<b>11-2455-21</b>	<b>11-2950-21</b>	<b>11-2955-21</b>	
23 cm / 9"	<b>11-2450-23</b>	<b>11-2455-23</b>	<b>11-2950-23</b>	<b>11-2955-23</b>	

		mit Sperre / with lock / с кремальерой			
15 cm / 6"	<b>11-2460-15</b>	<b>11-2465-15</b>	<b>11-2960-15</b>	<b>11-2965-15</b>	
18 cm / 7"	<b>11-2460-18</b>	<b>11-2465-18</b>	<b>11-2960-18</b>	<b>11-2965-18</b>	
21 cm / 8 1/4"	<b>11-2460-21</b>	<b>11-2465-21</b>	<b>11-2960-21</b>	<b>11-2965-21</b>	
23 cm / 9"	<b>11-2460-23</b>	<b>11-2465-23</b>	<b>11-2960-23</b>	<b>11-2965-23</b>	

		ohne Sperre / without lock / без кремальеры		ohne Sperre / without lock / без кремальеры	
		0,8 x 1,4 mm		0,8 x 1,4 mm	
15 cm / 6"	<b>11-2400-15</b>	<b>11-2405-15</b>	<b>11-2900-15</b>	<b>11-2905-15</b>	
18 cm / 7"	<b>11-2400-18</b>	<b>11-2405-18</b>	<b>11-2900-18</b>	<b>11-2905-18</b>	
21 cm / 8 1/4"	<b>11-2400-21</b>	<b>11-2405-21</b>	<b>11-2900-21</b>	<b>11-2905-21</b>	
23 cm / 9"	<b>11-2400-23</b>	<b>11-2405-23</b>	<b>11-2900-23</b>	<b>11-2905-23</b>	

		mit Sperre / with lock / с кремальерой			
15 cm / 6"	<b>11-2410-15</b>	<b>11-2415-15</b>	<b>11-2910-15</b>	<b>11-2915-15</b>	
18 cm / 7"	<b>11-2410-18</b>	<b>11-2415-18</b>	<b>11-2910-18</b>	<b>11-2915-18</b>	
21 cm / 8 1/4"	<b>11-2410-21</b>	<b>11-2415-21</b>	<b>11-2910-21</b>	<b>11-2915-21</b>	
23 cm / 9"	<b>11-2410-23</b>	<b>11-2415-23</b>	<b>11-2910-23</b>	<b>11-2915-23</b>	

Glatte Maulteile /  
 Smooth Jaws /  
 Гладкие губки



1,3 x 2,0 mm

Wolfram-Carbid-Beschichtung /  
 Wolfram Carbide Tip Coating /  
 Покрытие из карбида вольфрама



1,3 x 2,0 mm

		ohne Sperre / without lock / без кремальеры			
15 cm / 6"	<b>11-2470-15</b>	<b>11-2475-15</b>	<b>11-2970-15</b>	<b>11-2975-15</b>	
18 cm / 7"	<b>11-2470-18</b>	<b>11-2475-18</b>	<b>11-2970-18</b>	<b>11-2975-18</b>	
21 cm / 8 1/4"	<b>11-2470-21</b>	<b>11-2475-21</b>	<b>11-2970-21</b>	<b>11-2975-21</b>	
23 cm / 9"	<b>11-2470-23</b>	<b>11-2475-23</b>	<b>11-2970-23</b>	<b>11-2975-23</b>	

		mit Sperre / with lock / с кремальерой			
15 cm / 6"	<b>11-2480-15</b>	<b>11-2485-15</b>	<b>11-2930-15</b>	<b>11-2935-15</b>	
18 cm / 7"	<b>11-2480-18</b>	<b>11-2485-18</b>	<b>11-2930-18</b>	<b>11-2935-18</b>	
21 cm / 8 1/4"	<b>11-2480-21</b>	<b>11-2485-21</b>	<b>11-2930-21</b>	<b>11-2935-21</b>	
23 cm / 9"	<b>11-2480-23</b>	<b>11-2485-23</b>	<b>11-2930-23</b>	<b>11-2935-23</b>	



**BARRAQUER**

**Mikro-Nadelhalter  
Micro Needle Holders  
Porte-aiguilles micro  
Micro Porta-agujas  
Микро-иглодержатели**



**YASARGIL**

Glatte Maulteile /  
Smooth Jaws /  
Гладкие губки

12 x 1,0 x 1,5 mm



Wolfram-Carbid-Beschichtung /  
Wolfram Carbide Tip Coating /  
Покрытие из карбида вольфрама

12 x 1,0 x 1,5 mm

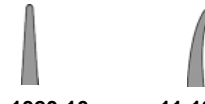

16,5 cm / 6 1/2"  
20 cm / 8"

11-1310-16  
11-1310-20

11-1315-16  
11-1315-20

11-1320-16  
11-1320-20

11-1325-16  
11-1325-20

Glatte Maulteile /  
Smooth Jaws /  
Гладкие губки

12 x 1,0 x 1,5 mm



Wolfram-Carbid-Beschichtung /  
Wolfram Carbide Tip Coating /  
Покрытие из карбида вольфрама

12 x 1,0 x 1,5 mm



23 cm / 9"  
24,5 cm / 9 2/3"

11-1310-23  
11-1310-24

11-1315-23  
11-1315-24

11-1320-23  
11-1320-24

11-1325-23  
11-1325-24



**YASARGIL**

Glatte Maulteile /  
Smooth Jaws /  
Гладкие губки

0,7 x 1,2 mm



Wolfram-Carbid-Beschichtung /  
Wolfram Carbide Tip Coating /  
Покрытие из карбида вольфрама

0,7 x 1,2 mm



ohne Sperre / without lock / без кремальеры

11-1010-23

11-1015-23

11-1110-23

11-1115-23

mit Sperre / with lock / с кремальерой

11-1020-23

11-1025-23

11-1120-23

11-1125-23



**YASARGIL**  
23 cm / 9"



BARRAQUER - Titan

Glatte Maulteile /  
Smooth Jaws /  
Гладкие губки

Wolfram-Carbid-Beschichtung /  
Wolfram Carbide Tip Coating /  
Покрытие из карбида вольфрама

0,4 x 1,1 mm

0,4 x 1,1 mm



ohne Sperre / without lock / без кремальеры

18 cm / 7"	<b>11-21450-18</b>	<b>11-21455-18</b>	<b>11-21950-18</b>	<b>11-21955-18</b>
21 cm / 8 1/4"	<b>11-21450-21</b>	<b>11-21455-21</b>	<b>11-21950-21</b>	<b>11-21955-21</b>

mit Sperre / with lock / с кремальерой

18 cm / 7"	<b>11-21460-18</b>	<b>11-21465-18</b>	<b>11-21960-18</b>	<b>11-21965-18</b>
21 cm / 8 1/4"	<b>11-21460-21</b>	<b>11-21465-21</b>	<b>11-21960-21</b>	<b>11-21965-21</b>

0,8 x 1,4 mm

0,8 x 1,4 mm

ohne Sperre / without lock / без кремальеры

18 cm / 7"	<b>11-21400-18</b>	<b>11-21405-18</b>	<b>11-21900-18</b>	<b>11-21905-18</b>
21 cm / 8 1/4"	<b>11-21400-21</b>	<b>11-21405-21</b>	<b>11-21900-21</b>	<b>11-21905-21</b>

mit Sperre / with lock / с кремальерой

18 cm / 7"	<b>11-21410-18</b>	<b>11-21415-18</b>	<b>11-21910-18</b>	<b>11-21915-18</b>
21 cm / 8 1/4"	<b>11-21410-21</b>	<b>11-21415-21</b>	<b>11-21910-21</b>	<b>11-21915-21</b>

Glatte Maulteile /  
Smooth Jaws /  
Гладкие губки

Wolfram-Carbid-Beschichtung /  
Wolfram Carbide Tip Coating /  
Покрытие из карбида вольфрама

1,3 x 2,0 mm

1,3 x 2,0 mm



ohne Sperre / without lock / без кремальеры

18 cm / 7"	<b>11-21470-18</b>	<b>11-21475-18</b>	<b>11-21970-18</b>	<b>11-21975-18</b>
21 cm / 8 1/4"	<b>11-21470-21</b>	<b>11-21475-21</b>	<b>11-21970-21</b>	<b>11-21975-21</b>

mit Sperre / with lock / с кремальерой

18 cm / 7"	<b>11-21480-18</b>	<b>11-21485-18</b>	<b>11-21930-18</b>	<b>11-21935-18</b>
21 cm / 8 1/4"	<b>11-21480-21</b>	<b>11-21485-21</b>	<b>11-21930-21</b>	<b>11-21935-21</b>



BARRAQUER - Titan

# Chirurgische Nadeln Surgical Needles Хирургические иглы

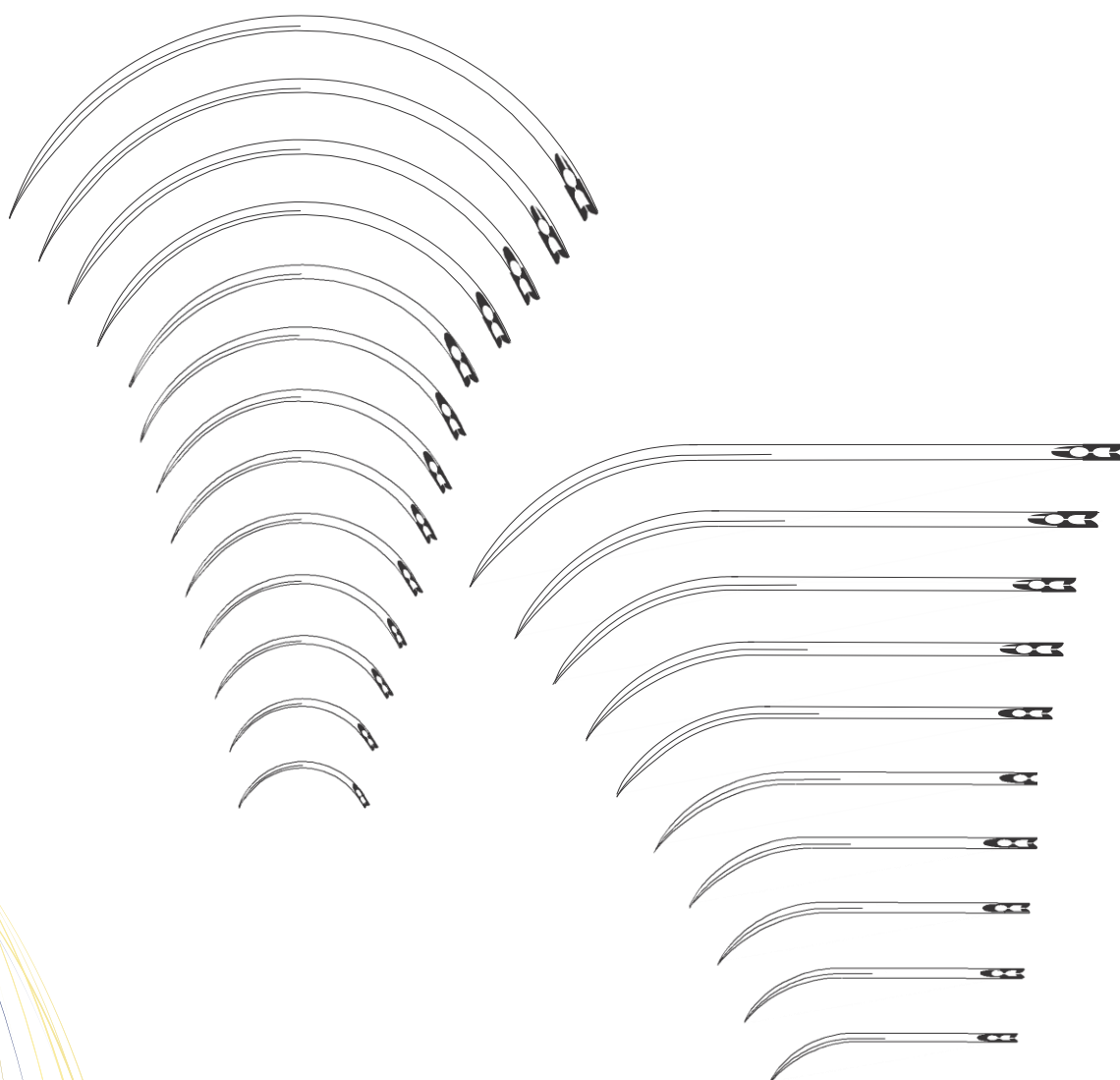





Abbildungen zeigen die natürliche Größe der chirurgischen Nadeln /  
Figures show the natural size of the surgical needles /  
Изображения показывают естественный размер хирургических игл

Öhr / Ear / Ушко



Gewöhnliches Öhr - ungerade Nummern  
Usual ear - odd numbers  
Обычное ушко - нечетные номера



Federöhr - gerade Nummern  
feather ear - just numbers  
Пружинное ушко - четные номера

Biegung / Bend / Изгиб



gerade / straight / прямой



halbgebogen / half straight / полуизогнутый



$\frac{3}{8}$  Kreis / circle / круга



$\frac{1}{2}$  Kreis / circle / круга



$\frac{5}{8}$  Kreis / circle / круга



Hakenförmig / hook-shaped / в форме крючка



S-förmig / S-shaped / S-форма

Diameter / Diameter / Диаметр

Länge / Length / Длина

Spitze / Top / Остриё



außenschneidend rund / cutting around the outside / резка наружу



trokar / trocar / троакар



rund / round / круглое



innenschneidend / inside cutting / резка внутрь

Bestellnummer / Referenznummer / Номер заказа

<b>12-</b>	<b>11</b>	<b>-</b>		<b>12-</b>	<b>11</b>	<b>S</b>
Nadeltyp	Größe	Unsteril	oder	Nadeltyp	Größe	Unsteril
Needle type	Size	Unsterile	or	Needle type	Size	Unsterile
Тип иглы	Размер	Нестерильный	или	Тип иглы	Размер	Нестерильный

Verpackung / Packaging / Упаковка

1 Dtzd. / PE-Beutel (unsteril) / PE bags (unsterile) / PE-мешочек (нестерильный)

Individuelle Verpackung auf Anfrage / Custom packaging on request / индивидуальная упаковка по запросу

Chirurgische Nadeln  
Surgical Needles  
Хирургические иглы

Nadeltyp:      Öhr      Spitze

12-01-000		▼
12-01-001		▼
12-01-002		●
12-01-003		●
12-01-004		⊙
12-01-005		⊙

	<sup>1</sup> / <sub>2</sub> Kreis	
	Diameter	Länge
000	1,80	100
00	1,60	92
0	1,60	85
1	1,40	80
2	1,40	75
3	1,30	70
4	1,30	65
5	1,20	60
6	1,20	55
7	1,10	50
8	1,00	45
9	1,00	40
10	0,90	36
11	0,80	32
12	0,80	28
13	0,70	25
14	0,70	22
15	0,60	20
16	0,60	18

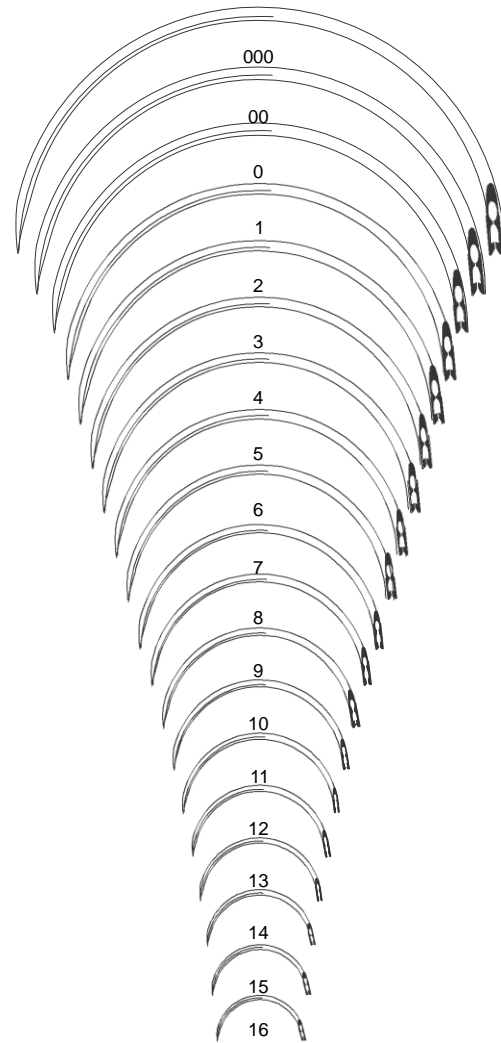

Nadeltyp:      Öhr Spitze

12-01-020		●
12-01-021		●
12-01-022		⊙
12-01-023		⊙

	<sup>1</sup> / <sub>2</sub> Kreis	
	Diameter	Länge
000	1,30	70
00	1,20	60
0	1,20	55
1	1,00	47
2	1,00	40
3	0,80	32
4	0,80	28
5	0,70	22
6	0,60	18
7	0,50	15
8	0,50	12

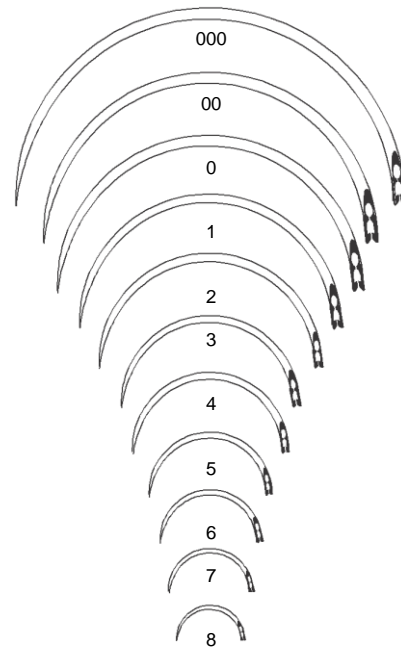



Nadeltyp:	Öhr	Spitze
12-01-012		
12-01-013		
12-01-014		
12-01-015		
12-01-016		
12-01-017		

	<sup>1</sup> / <sub>2</sub> Kreis	
	Diameter	Länge
000	2,00	90
00	1,80	80
0	1,80	70
1	1,60	60
2	1,60	55
3	1,50	50
4	1,40	45
5	1,30	40
6	1,20	35
7	1,10	30
8	1,00	25
9	0,90	22
10	0,80	19
11	0,80	16

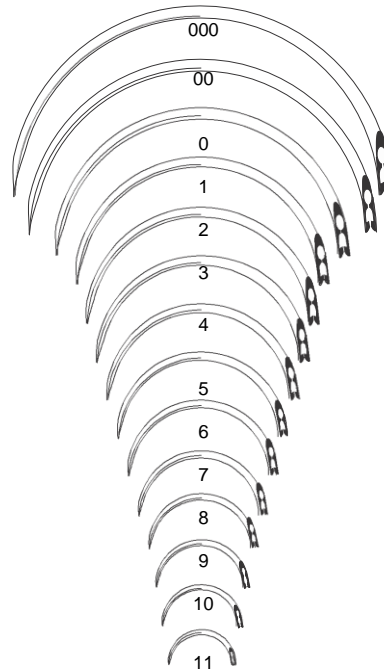

Nadeltyp:	Öhr	Spitze
12-01-006		
12-01-007		
12-01-008		
12-01-009		
12-01-010		
12-01-011		

	<sup>2</sup> / <sub>3</sub> Kreis	
	Diameter	Länge
000	1,80	100
00	1,60	92
0	1,60	85
1	1,40	80
2	1,40	75
3	1,30	70
4	1,30	65
5	1,20	60
6	1,20	55
7	1,10	50
8	1,00	45
9	1,00	40
10	0,90	36
11	0,80	32
12	0,80	28
13	0,70	25
14	0,70	22
15	0,60	20
16	0,60	18

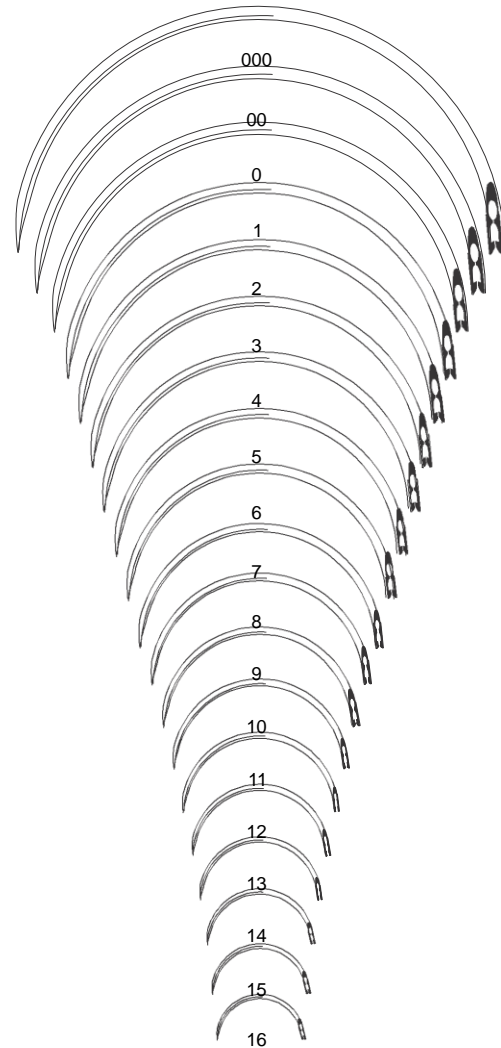

Nadeltyp:	Öhr	Spitze
12-01-018		▼
12-01-019		▼

<sup>3/8</sup> Kreis		
	Diameter	Länge
1	1,40	45
2	1,30	40
3	1,20	35
4	1,10	30

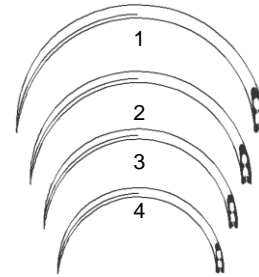

Nadeltyp:	Öhr	Spitze
12-01-024		▲
12-01-025		▲
12-01-026		●
12-01-027		●

gerade		
	Diameter	Länge
0	1,00	80
1	0,90	75
2	0,90	70
3	0,90	65
4	0,80	60
5	0,80	55
6	0,80	50
7	0,70	45

**Keith**

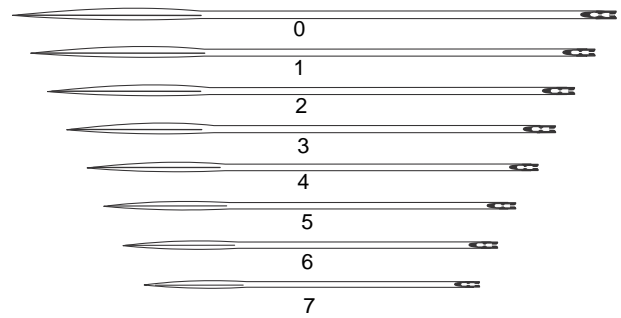

Nadeltyp:	Öhr	Spitze
12-01-034		▼
12-01-035		●
12-01-036		●
12-01-037		●

<sup>5/8</sup> Kreis		
	Diameter	Länge
00	1,40	75
0	1,20	60
1	1,10	52
2	1,00	45
3	0,90	38
4	0,80	30
5	0,70	22

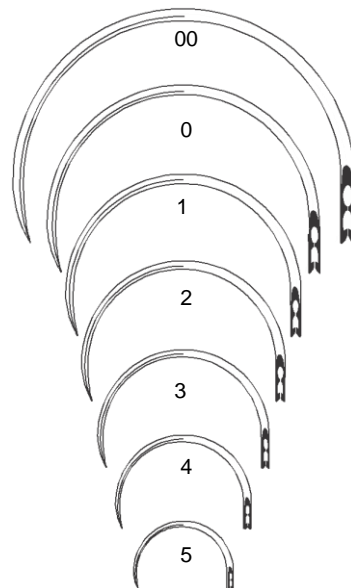

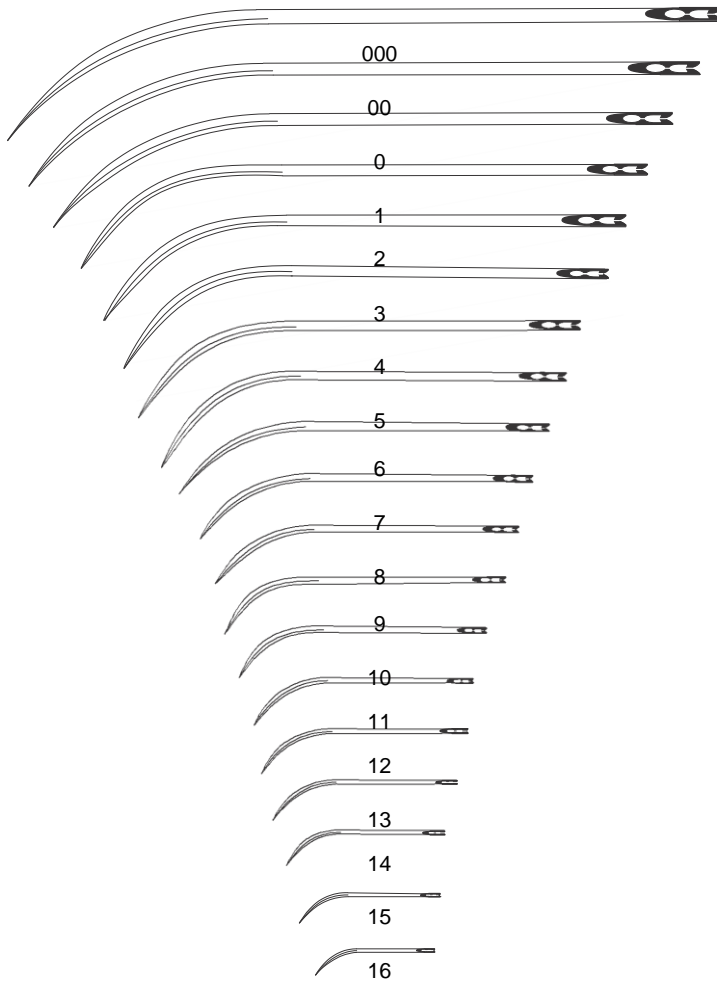

Nadeltyp:	Öhr	Spitze
12-01-028		▼
12-01-029		●
12-01-030		▼
12-01-031		●

	halbgebogen	
	Diameter	Länge
000	1,80	100
00	1,60	92
0	1,60	85
1	1,40	80
2	1,40	75
3	1,30	70
4	1,30	65
5	1,20	60
6	1,20	55
7	1,10	50
8	1,00	45
9	1,00	40
10	0,90	36
11	0,80	32
12	0,80	28
13	0,70	25
14	0,70	22
15	0,60	20
16	0,60	18

**König**

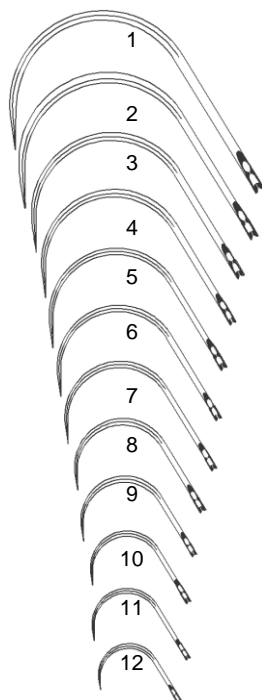

Nadeltyp:	Öhr	Spitze
12-01-032		▼
12-01-033		▼

	Hakenförmig	
	Diameter	Länge
1	1,20	55
2	1,10	50
3	1,00	45
4	1,00	40
5	0,90	36
6	0,80	34
7	0,80	32
8	0,80	30
9	0,80	26
10	0,70	23
11	0,60	20
12	0,60	18

Chirurgische Nadeln  
Surgical Needles  
Хирургические иглы

Nadeltyp:    Öhr    Spitze

12-01-038  
12-01-039  
12-01-040  
12-01-041

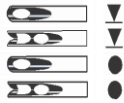

	$\frac{3}{8}$ Kreis	
	Diameter	Länge
1	1,40	80
2	1,40	75
3	1,30	70
4	1,30	65
5	1,20	60
6	1,20	55
7	1,10	52
8	1,10	50
9	1,00	47
10	1,00	45
11	1,00	40
12	0,90	38
13	0,90	36
14	0,80	34
15	0,80	32
16	0,80	30
17	0,80	28
18	0,70	25
19	0,70	23
20	0,70	22
21	0,60	20
22	0,60	18

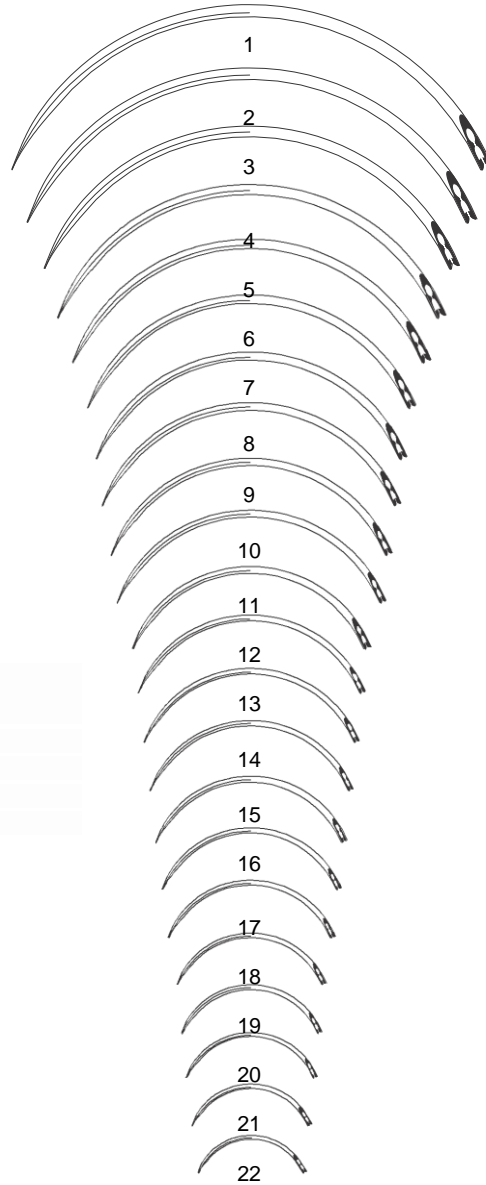

**Ferguson**

Nadeltyp:    Öhr    Spitze

12-01-046  
12-01-047



	$\frac{1}{2}$ Kreis	
	Diameter	Länge
1	1,40	74
2	1,30	63
3	1,10	50
4	1,00	40
5	0,80	34
6	0,70	23

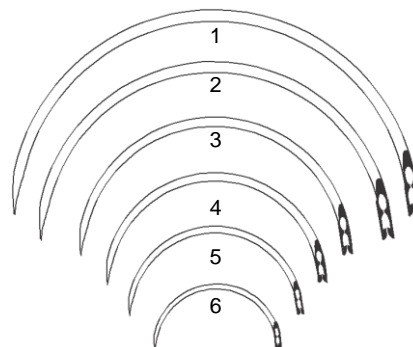



Chirurgische Nadeln  
Surgical Needles  
Хирургические иглы

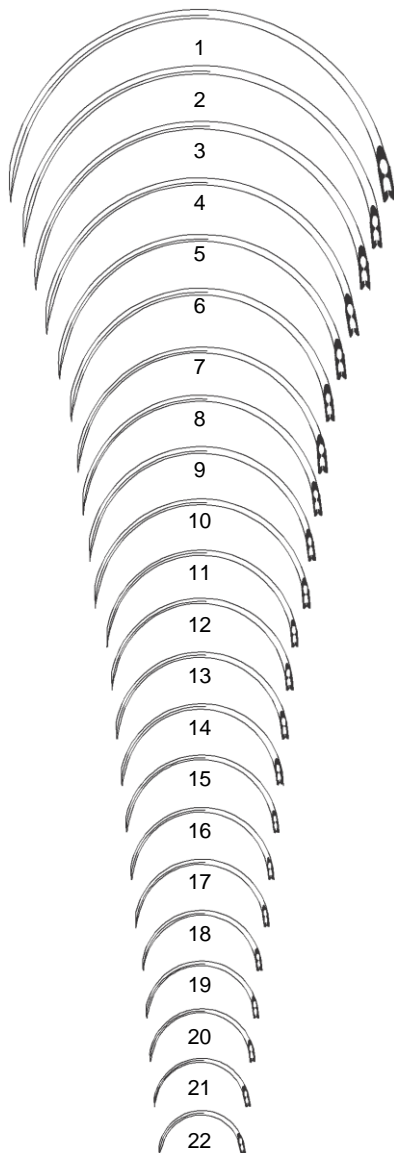

Nadeltyp:	Öhr	Spitze
12-01-042		
12-01-043		
12-01-044		
12-01-045		

	<sup>1</sup> / <sub>2</sub> Kreis	
	Diameter	Länge
1	1,40	80
2	1,40	75
3	1,30	70
4	1,30	65
5	1,20	60
6	1,20	55
7	1,10	52
8	1,10	50
9	1,00	47
10	1,00	45
11	1,00	40
12	0,90	38
13	0,90	36
14	0,80	34
15	0,80	32
16	0,80	30
17	0,80	28
18	0,70	25
19	0,70	23
20	0,70	22
21	0,60	20
22	0,60	18

**Mayo**

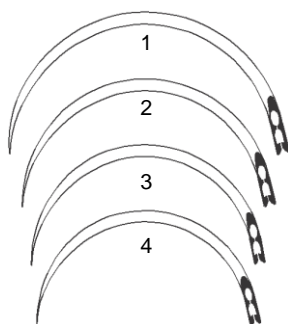

Nadeltyp:	Öhr	Spitze
12-01-048		
12-01-049		
12-01-050		
12-01-051		

	<sup>1</sup> / <sub>2</sub> Kreis	
	Diameter	Länge
1	1,50	50
2	1,40	45
3	1,40	42
4	1,30	40

## Darfnadeln

Nadeltyp:    Öhr    Spitze

12-01-052  
12-01-053



	$\frac{3}{8}$ Kreis	
	Diameter	Länge
00	0,80	75
0	0,80	65
1	0,70	55
2	0,70	45
3	0,60	36
4	0,60	30
5	0,60	25
6	0,60	22
7	0,50	20
8	0,50	18
9	0,50	15
10	0,50	12

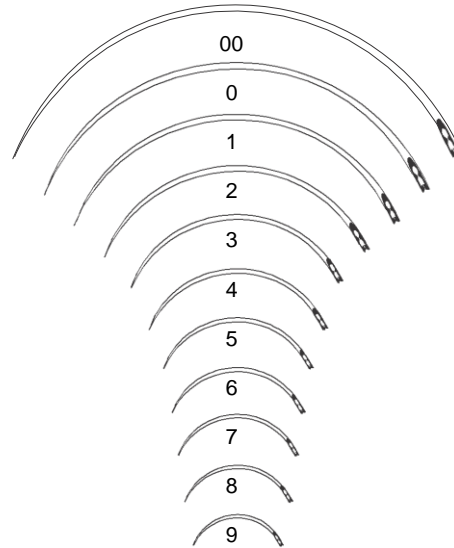

Nadeltyp:    Öhr    Spitze

12-01-054  
12-01-055



	$\frac{1}{2}$ Kreis	
	Diameter	Länge
00	0,80	75
0	0,80	65
1	0,70	55
2	0,70	45
3	0,60	36
4	0,60	30
5	0,60	25
6	0,60	22
7	0,50	20
8	0,50	18
9	0,50	15
10	0,50	12

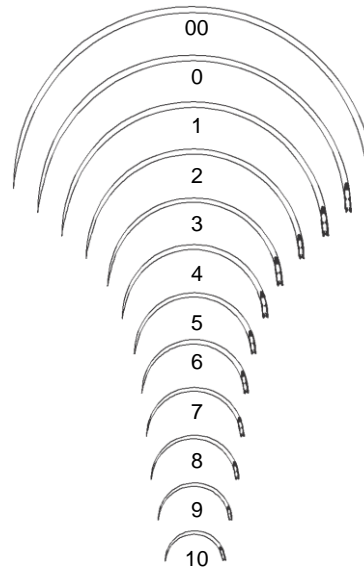

Nadeltyp:    Öhr    Spitze

12-01-053  
12-01-053



	Gerade	
	Diameter	Länge
00	0,80	75
0	0,80	65
1	0,70	55
2	0,70	45
3	0,60	36
4	0,60	30
5	0,60	25
6	0,60	22
7	0,50	20
8	0,50	18
9	0,50	15
10	0,50	12

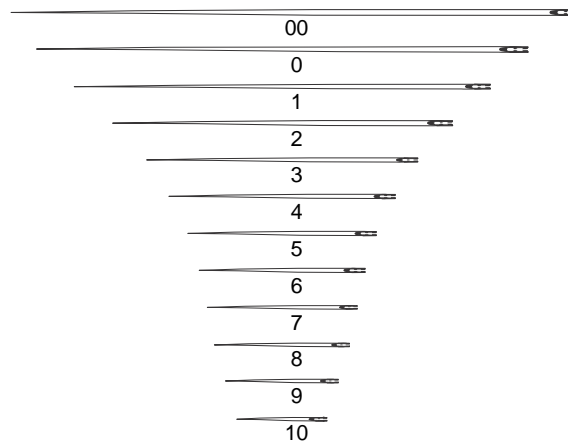



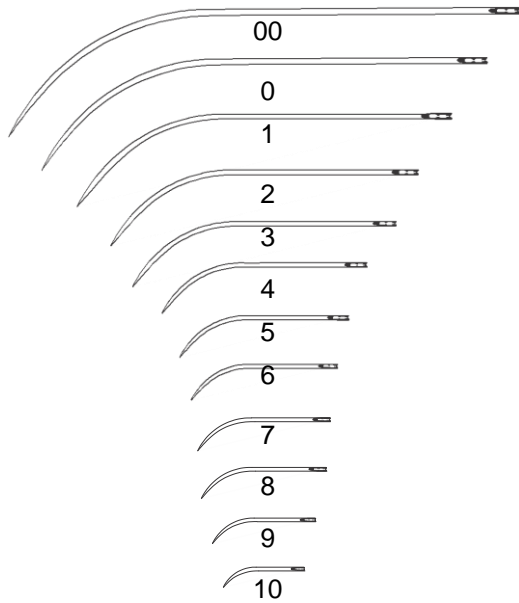

Nadeltyp:	Öhr	Spitze
12-01-058		
12-01-059		

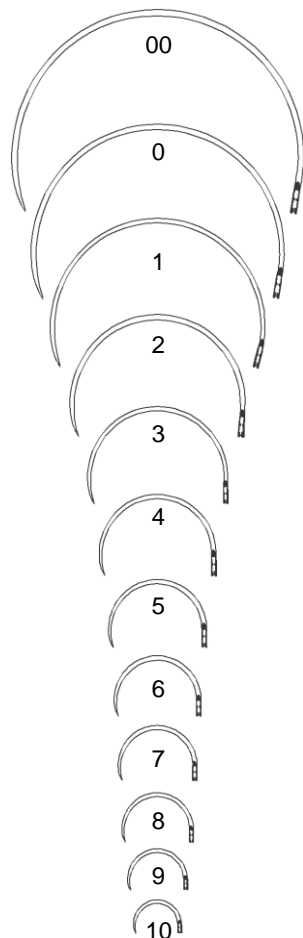

	halbgebogen	
	Diameter	Länge
00	0,80	75
0	0,80	65
1	0,70	55
2	0,70	45
3	0,60	36
4	0,60	30
5	0,60	25
6	0,60	22
7	0,50	20
8	0,50	18
9	0,50	15
10	0,50	12



Nadeltyp:	Öhr	Spitze
12-01-060		
12-01-061		

	<sup>5</sup> / <sub>8</sub> Kreis	
	Diameter	Länge
00	0,80	75
0	0,80	65
1	0,70	55
2	0,70	45
3	0,60	36
4	0,60	30
5	0,60	25
6	0,60	22
7	0,50	20
8	0,50	18
9	0,50	15
10	0,50	12

## Gefäß- und Augennadeln

Nadeltyp:    Öhr    Spitze  
12-01-062        ▼  
12-01-063        ▼

	halbgebogen	
	Diameter	Länge
0	0,60	36
1	0,60	30
2	0,50	25
3	0,50	21
4	0,50	18
5	0,50	15
6	0,50	12

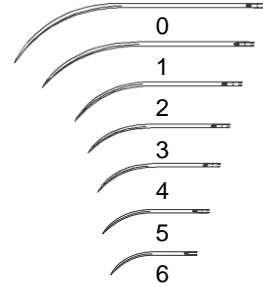

Nadeltyp:    Öhr    Spitze  
12-01-064        ▼  
12-01-065        ▼

	<sup>3/8</sup> Kreis	
	Diameter	Länge
0	0,60	36
1	0,60	30
2	0,50	25
3	0,50	21
4	0,50	18
5	0,50	15
6	0,50	12

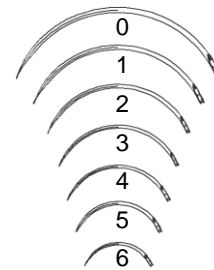

Nadeltyp:    Öhr    Spitze  
12-01-066        ▼  
12-01-067        ▼

	<sup>1/2</sup> Kreis	
	Diameter	Länge
0	0,60	36
1	0,60	30
2	0,50	25
3	0,50	21
4	0,50	18
5	0,50	15
6	0,50	12

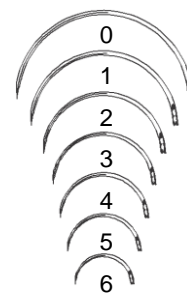

Nadeltyp:    Öhr    Spitze  
12-01-068        ●

	<sup>1/2</sup> Kreis	
	Diameter	Länge
00	0,35	30
0	0,35	25
1	0,35	22
2	0,35	18
3	0,35	16
<b>4</b>	<b>0,35</b>	<b>12</b>

**Kalt**

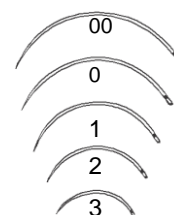

**Neumann**

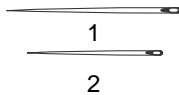

Nadeltyp:    Öhr    Spitze



	gerade	
	Diameter	Länge
1	0,70	23
2	0,60	18

**Gefäß- und Augennadeln**

**Payr**

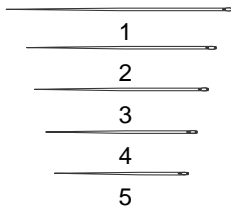

Nadeltyp:    Öhr    Spitze



	gerade	
	Diameter	Länge
1	0,35	30
2	0,35	25
3	0,35	22
4	0,35	20
5	0,35	16
<b>6</b>	<b>0,35</b>	<b>12</b>

**Payr**

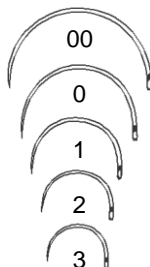



Nadeltyp:    Öhr    Spitze



	<sup>1</sup> / <sub>2</sub> Kreis	
	Diameter	Länge
00	0,35	30
0	0,35	25
1	0,35	22
2	0,35	18
3	0,35	16
<b>4</b>	<b>0,35</b>	<b>12</b>

### Sektionsnadeln

Nadeltyp:    Öhr    Spitze  
12-01-073      

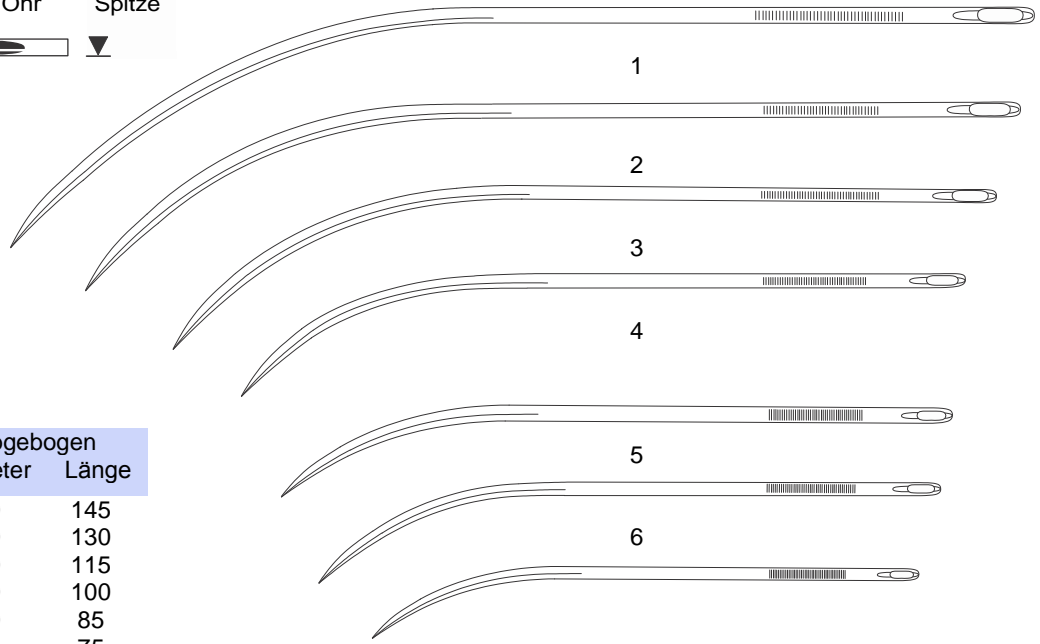

	halbgebogen	
	Diameter	Länge
1	2,00	145
2	2,00	130
3	2,00	115
4	2,00	100
5	1,80	85
6	1,80	75

Nadeltyp:    Öhr    Spitze  
12-01-074      

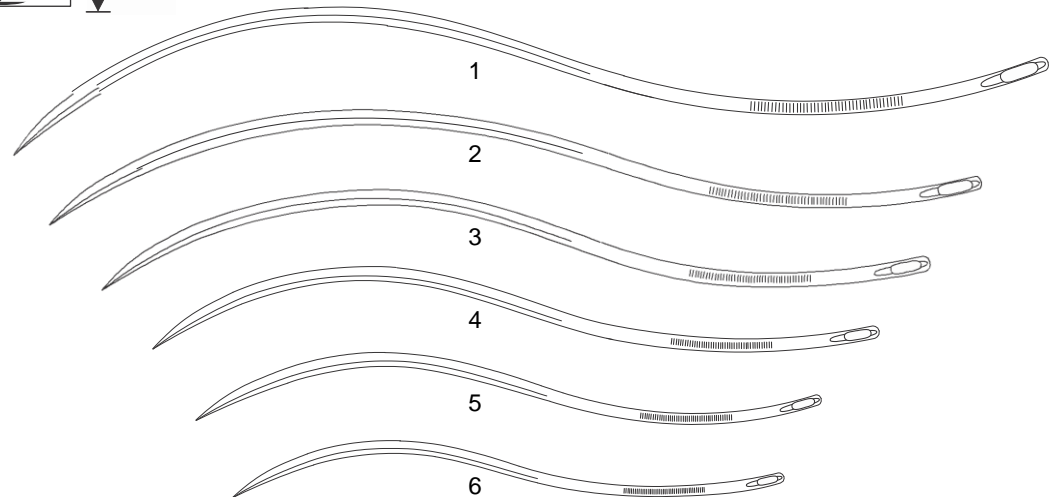

	s-förmig	
	Diameter	Länge
1	2,00	145
2	2,00	130
3	2,00	115
4	2,00	100
5	1,80	85
6	1,80	75

Tierärztliche Nadeln

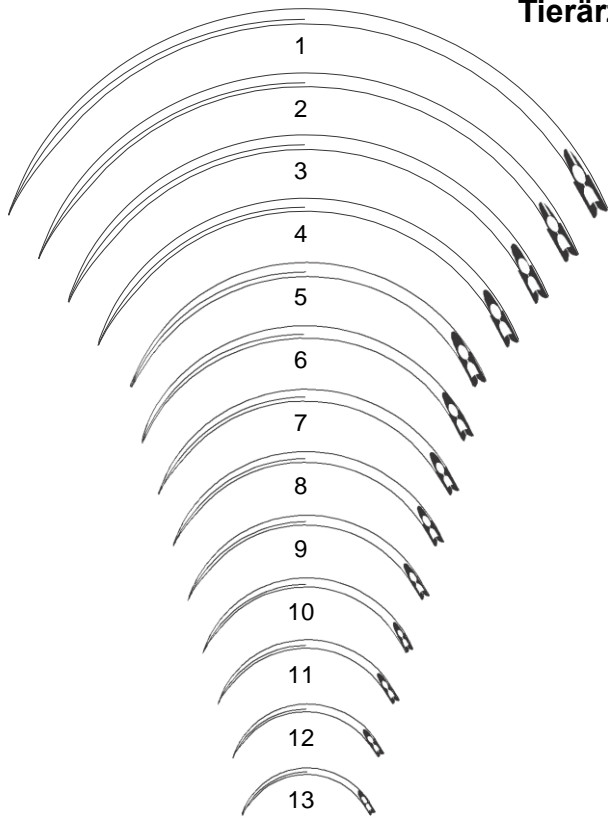

Nadeltyp:  Ohr  Spitze

12-01-075



	<sup>3</sup> / <sub>8</sub> Kreis	
	Diameter	Länge
1	2,00	100
2	2,00	90
3	1,80	80
4	1,80	70
5	1,60	60
6	1,60	55
7	1,50	50
8	1,40	45
9	1,30	40
10	1,20	35
11	1,10	30
12	1,00	25
13	0,90	22

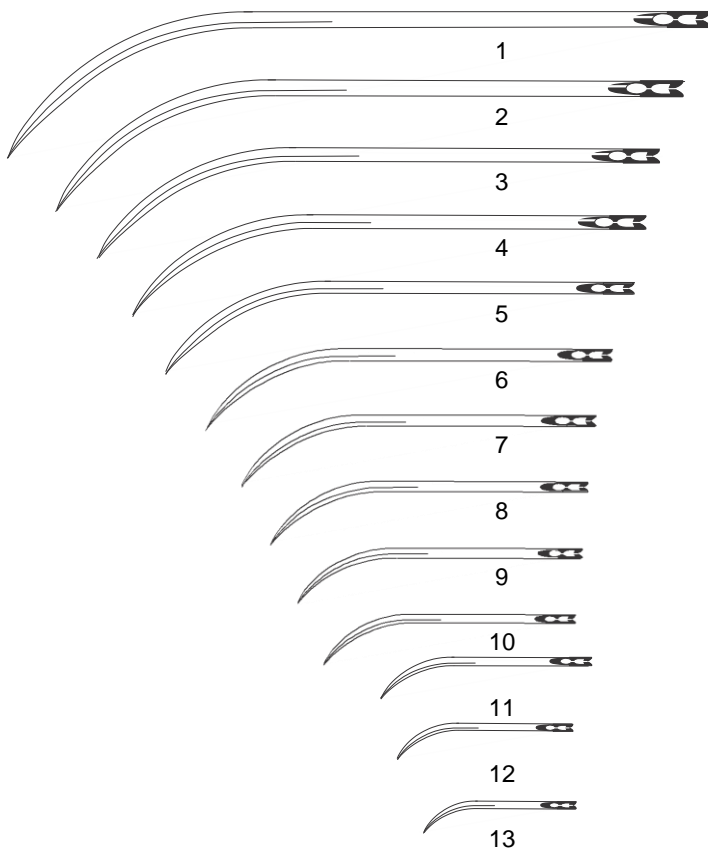

Nadeltyp:  Ohr  Spitze

12-01-076



	gerade	
	Diameter	Länge
1	2,00	100
2	2,00	90
3	1,80	80
4	1,80	70
5	1,60	60
6	1,60	55
7	1,50	50
8	1,40	45
9	1,30	40
10	1,20	35
11	1,10	30
12	1,00	25
13	0,90	22











Leicht  
Medizintechnik









**Wundhaken  
Retractors  
Ecarteurs  
Separadores  
Ранорасширители**





Dura- und Hauthäkchen  
Dura and Skin Retractors  
Crochets pour la peau  
Gancho para piel y dura-madre  
Крючки мозговые и кожные

 <b>GILLIES</b> 18,0 cm, 7"	 <b>KILNER</b> 15,0 cm, 6" 13-28-054-15	 <b>FRAZIER</b>	 <b>O'CONNOR</b> 16,0 cm, 6¼" 13-28-074-16
 Fig. 1 13-28-050-01	 Fig. 2 13-28-050-02	 scharf sharp pointu agudos острые 13,0 cm, 5" 13-28-060-13 18,0 cm, 7" 13-28-060-18	
		 stumpf blunt mousse romo тупые 13,0 cm, 5" 13-28-061-13 18,0 cm, 7" 13-28-061-18	

 <b>KLEINERT-KUTZ</b> 16,0 cm, 6¼"	 <b>JOSEPH</b> 16,0 cm, 6¼" 13-28-280-16	 <b>GRAEFE</b> 16,0 cm, 6¼"
 Fig. 1 13-28-058-01	 Fig. 2 13-28-058-02	 Fig. 1 13-28-078-01
 Fig. 3 13-28-058-03	 Fig. 2 13-28-078-02	

Schleimhauthäkchen  
Mucosa Hooklet  
Crochet pour la muqueuse  
Ganchito para mucosa  
Крючок для слизистой



**Dura- und Hauthäkchen**  
**Dura and Skin Retractors**  
**Crochets pour la peau**  
**Gancho para piel y dura-madre**  
**Крючки мозговые и кожные**



scharf  
sharp  
pointu  
agudos  
острые



Fig. 1  
13,0 cm, 5"  
13-28-070-01





Fig. 2  
18,0 cm, 7"  
13-28-070-02



stumpf  
blunt  
mousse  
romo  
тупые

Fig. 3  
13,0 cm, 5"  
13-28-070-03



Fig. 4  
18,0 cm, 7"  
13-28-070-04





Fig. 1  
13-28-080-01



Fig. 2  
13-28-080-02

**GUTHRIE**  
16,0 cm, 6¼"





Fig. 1  
13-28-086-02



Fig. 2  
13-28-086-05



Fig. 3  
13-28-086-07



Fig. 4  
13-28-086-10

Schleimhauthäkchen  
Mucosa Hooklet  
Crochet pour la muqueuse  
Ganchito para mucosa  
Крючок для слизистой

**JOSEPH**  
16,0 cm, 6¼"



**KNAPP**  
13,0 cm, 5"

Fig. 1  
13-28-082-01

Fig. 2  
13-28-082-02

scharf  
sharp  
pointu  
agudos  
острые

stumpf  
blunt  
mousse  
romo  
тупые

13-28-088-02    13-28-088-03    13-28-088-04

13-28-089-02    13-28-089-03    13-28-089-04

flexibel · flexible · malléable · flexibles · гибкие

16,0 cm, 6 1/4"

13-28-101-01    13-28-101-02    13-28-101-03    13-28-101-04

scharf  
sharp  
pointu  
agudos  
острые

13-28-103-01    13-28-103-02    13-28-103-03    13-28-103-04

halbscharf  
half-sharp  
semi-pointu  
semi-agudos  
полуострые

13-28-102-01    13-28-102-02    13-28-102-03    13-28-102-04

stumpf  
blunt  
mousse  
romo  
тупые

16,0 cm, 6 1/4"

Wundhaken  
 Retractors  
 Ecarteurs  
 Separadores  
 Ранорасширители-крючки



16,0 cm, 6¼"

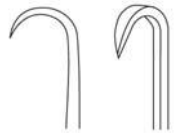

13-28-111-01



13-28-111-02



13-28-111-03



13-28-111-04

scharf  
 sharp  
 pointu  
 agudos  
 острые

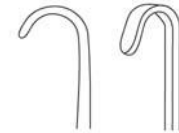

13-28-112-01



13-28-112-02



13-28-112-03

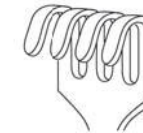

13-28-112-04

stumpf  
 blunt  
 mousse  
 romo  
 тупые



**CUSHING**  
 19,0 cm, 7½"



Fig. 1  
 13-28-140-01



Fig. 2  
 13-28-140-02



**LANGENBECK-GREEN**  
 16,0 cm, 6¼"



16 x 6 mm  
 13-28-162-01



24 x 6 mm  
 13-28-162-02



Wundhaken  
Retractors  
Ecarteurs  
Separadores  
Ранорасширители-крючки



**MEYERDING**  
18,0 cm, 7"



18 x 7 mm  
13-28-150-01



16 x 5 mm  
13-28-150-02



7 x 4 mm  
13-28-150-03



14 x 8 mm  
13-28-166-16



10 x 3 mm  
13-28-150-04



7 x 4 mm  
13-28-150-05



4 x 10 mm  
13-28-150-06



16,0 cm, 6 1/4"



**SENN-GREEN**  
15,0 cm, 6"



10 x 6 mm  
13-28-160-10



20 x 6 mm  
13-28-160-20



**MINI-LANGENBECK**  
16,0 cm, 6 1/4"



10 x 6 mm  
13-28-164-01



17 x 5 mm  
13-28-164-02



20 x 6 mm  
13-28-164-03

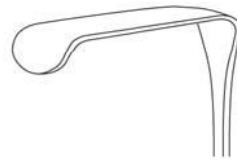

22 x 8 mm  
13-28-164-04

Wundhaken  
 Retractors  
 Ecarteurs  
 Separadores  
 Ранорасширители-крючки

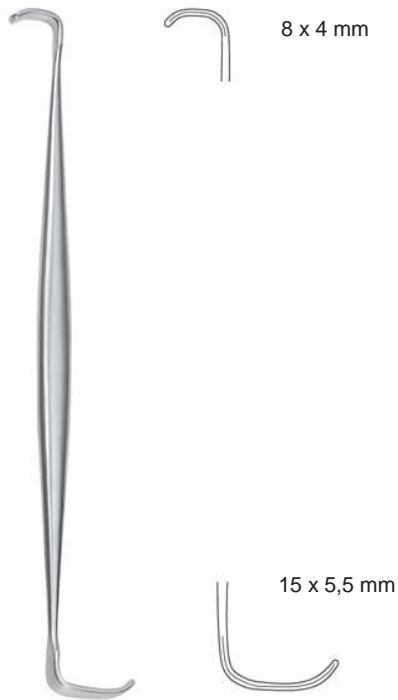

**RAGNELL-DAVIS**  
 14,0 cm, 5½"  
 13-28-170-14



**RAGNELL**  
 15,0 cm, 6"  
 13-28-174-15



13-28-178-15

13-28-179-15

scharf  
 sharp  
 pointu  
 agudos  
 острые

stumpf  
 blunt  
 mousse  
 romo  
 тупые

**BABY SENN-MILLER**  
 15,0 cm, 6"



13-28-180-16

13-28-181-16

scharf  
 sharp  
 pointu  
 agudos  
 острые

stumpf  
 blunt  
 mousse  
 romo  
 тупые

**SENN-MILLER**  
 16,0 cm, 6¼"



Sattelhäkchen, Wundhäkchen  
Saddle Hooks, Hooklets  
Ecarteurs sous forme de selle, Crochets  
Ganchos en forma de selle, Ganchitos  
Крючки для век, ранорасширители-крючочки



**DESMARRES**  
13,0 cm, 5



8 mm  
13-28-200-08



10 mm  
13-28-200-10



12 mm  
13-28-200-12

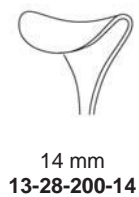

14 mm  
13-28-200-14

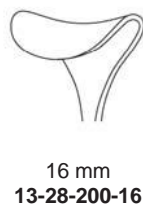

16 mm  
13-28-200-16

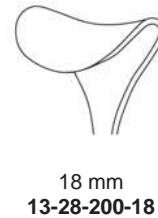

18 mm  
13-28-200-18



**DESMARRES**  
16,0 cm, 6¼"



8 mm  
13-28-204-08



10 mm  
13-28-204-10



12 mm  
13-28-204-12

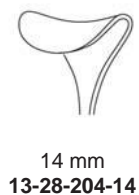

14 mm  
13-28-204-14

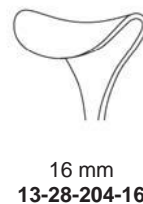

16 mm  
13-28-204-16

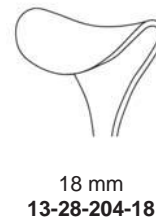

18 mm  
13-28-204-18

**Sattelhäkchen**  
**Saddle Hooks**  
**Ecarteurs sous forme de selle**  
**Ganchos en forma de selle**  
**Крючки для век**



**CUSHING**  
 20,0 cm, 8"



8 mm  
 13-28-210-08



10 mm  
 13-28-210-10



12 mm  
 13-28-210-12



14 mm  
 13-28-210-14

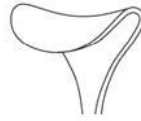

16 mm  
 13-28-210-16

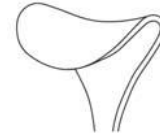

18 mm  
 13-28-210-18



**CUSHING**  
 24,0 cm, 9½"



8 mm  
 13-28-212-08



10 mm  
 13-28-212-10



12 mm  
 13-28-212-12



14 mm  
 13-28-212-14

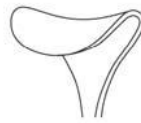

16 mm  
 13-28-212-16

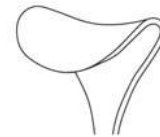

18 mm  
 13-28-212-18



Sattelhäkchen  
Saddle Hooks  
Ecarteurs sous forme de selle  
Ganchos en forma de selle  
Крючки для век



**GIL-VERNET**  
24,0 cm, 9½"



8 mm  
13-28-220-08



11 mm  
13-28-220-11



13 mm  
13-28-220-13



15 mm  
13-28-220-15



17 mm  
13-28-220-17



20 mm  
13-28-220-20



23 mm  
13-28-220-23



**GIL-VERNET**  
24,0 cm, 9½"



8 mm  
13-28-230-08



11 mm  
13-28-230-11



13 mm  
13-28-230-13



15 mm  
13-28-230-15



17 mm  
13-28-230-17



20 mm  
13-28-230-20



23 mm  
13-28-230-23



Wundhaken  
 Retractors  
 Ecarteurs  
 Separadores  
 Ранорасширители-крючки



Fig. 1 24 x 20 mm  
 Fig. 2 29 x 26 mm  
 Fig. 3 33 x 29 mm  
 Fig. 4 29 x 24 mm

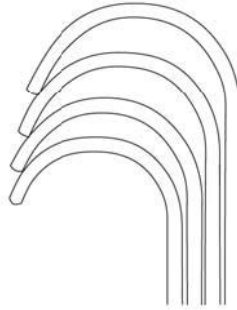

**13-28-310-00**  
 Satz, Fig. 1-3  
 Set, fig. 1-3  
 Set, figure 1-3  
 Juego, fig. 1-3  
 Набор фиг. 1-3

Fig. 1 30 x 28 mm  
 Fig. 2 36 x 36 mm  
 Fig. 3 38 x 43 mm  
 Fig. 4 45 x 28 mm

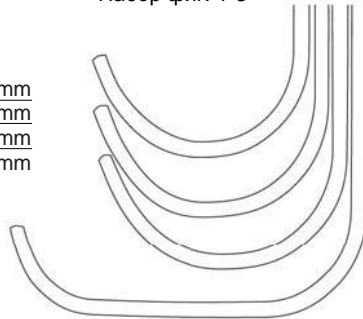

Fig. 1-3 17,0 cm, 6¾" **13-28-310-00**  
 Fig. 1 14,0 cm, 5½" **13-28-310-01**  
 Fig. 2 15,0 cm, 6" **13-28-310-02**  
 Fig. 3 17,0 cm, 6¾" **13-28-310-03**  
 Fig. 4 18,0 cm, 7" **13-28-310-04**

**ROUX**



Fig. 2 30 x 10 mm  
 Fig. 1 26 x 10 mm

**13-28-300-12**  
 Satz, Fig.1-2  
 Set, fig.1-2  
 Set, figure 1-2  
 Juego, fig.1-2  
 Набор фиг.1-2

Fig. 1 30 x 13 mm  
 Fig. 2 34 x 13 mm

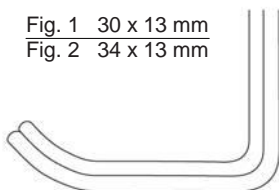

**FARABEUF**  
 12,0 cm, 4¾"



Fig. 2 23 x 16 mm  
 Fig. 1 27 x 16 mm

**13-28-302-15**  
 Satz, Fig.1-2  
 Set, fig.1-2  
 Set, figure 1-2  
 Juego, fig.1-2  
 Набор фиг.1-2

Fig. 1 26 x 16 mm  
 Fig. 2 30 x 16 mm

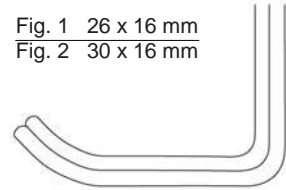

**FARABEUF**  
 15,0 cm, 5¾"



**MINI-ROUX**  
15,0 cm, 6"  
13-28-340-15



**BABY-ROUX**  
13,0 cm, 5"  
13-28-342-13

18 x 17 mm

24 x 21 mm



**PARKER**  
13,5 cm, 5 1/4"

Fig. 2 22 x 15 mm  
Fig. 1 19 x 15 mm

**13-28-350-13**  
Satz, Fig. 1-2  
Set, fig. 1-2  
Set, figure 1-2  
Juego, fig. 1-2  
Набор фиг. 1-2

Fig. 1 19 x 15 mm  
Fig. 2 22 x 15 mm



**PARKER**  
18,0 cm, 7"

Fig. 2 27 x 25 mm  
Fig. 1 24 x 25 mm

**13-28-350-18**  
Satz, Fig. 1-2  
Set, fig. 1-2  
Set, figure 1-2  
Juego, fig. 1-2  
Набор фиг. 1-2

Fig. 2 26 x 25 mm  
Fig. 1 29 x 25 mm



**MATHIEU**  
20,0 cm, 8"

Fig. 2 47 x 13 mm  
Fig. 1 42 x 13 mm

**13-28-380-00**  
Satz, Fig. 1-2  
Set, fig. 1-2  
Set, figure 1-2  
Juego, fig. 1-2  
Набор фиг. 1-2

Fig. 1 42 x 26 mm  
Fig. 2 46 x 26 mm

Wundhaken  
 Retractors  
 Ecarteurs  
 Separadores  
 Ранорасширители-крючки



**GOELET**  
 19,0 cm, 7½"  
 13-28-396-19

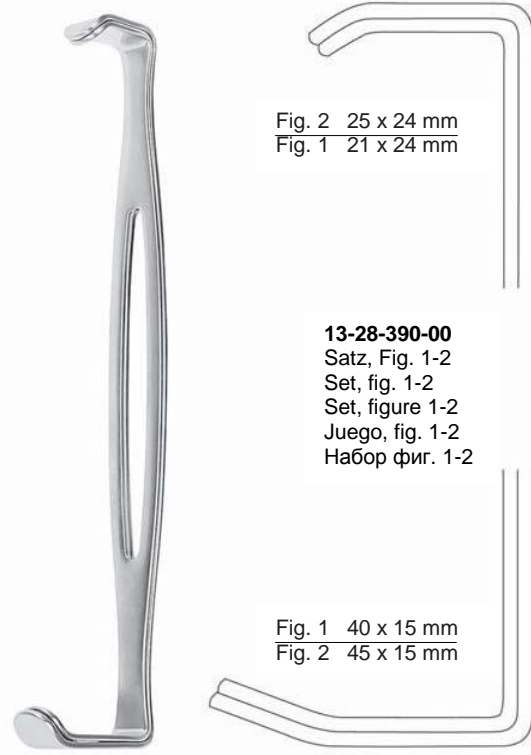

**PARKER-LANGENBECK**  
 21,0 cm, 8¼"

Fig. 2 25 x 24 mm  
 Fig. 1 21 x 24 mm

**13-28-390-00**  
 Satz, Fig. 1-2  
 Set, fig. 1-2  
 Set, figure 1-2  
 Juego, fig. 1-2  
 Набор фиг. 1-2

Fig. 1 40 x 15 mm  
 Fig. 2 45 x 15 mm

Fig. 1 13-28-390-01  
 Fig. 2 13-28-390-02



**CANNY RYAL**

16 mm	19,0 cm, 7½"	<b>13-28-370-16</b>
20 mm	19,0 cm, 7½"	<b>13-28-370-20</b>
25 mm	20,0 cm, 8"	<b>13-28-370-25</b>

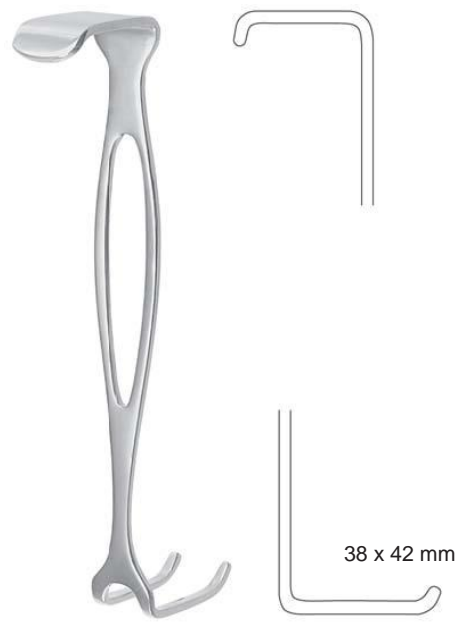

**CZERNY**  
 17,5 cm, 7"  
 13-28-360-00

38 x 42 mm



**Wundhaken  
Retractors  
Ecarteurs  
Separadores  
Ранорасширители-крючки**



								scharf sharp pointu agudos острые		
13-29-001-01	13-29-001-02	13-29-001-03	13-29-001-04	13-29-001-06	13-29-001-08	9 x 8 mm	9 x 13 mm	9 x 19 mm	9 x 29 mm	9 x 40 mm
								halbscharf half-sharp semi-pointu semi-agudos полуострые		
13-29-003-01	13-29-003-02	13-29-003-03	13-29-003-04	13-29-003-06	13-29-003-08	9 x 8 mm	9 x 13 mm	9 x 19 mm	9 x 29 mm	9 x 40 mm
								stumpf blunt mousse romo тупые		
13-29-002-01	13-29-002-02	13-29-002-03	13-29-002-04	13-29-002-06	13-29-002-08	9 x 8 mm	9 x 13 mm	9 x 19 mm	9 x 29 mm	9 x 40 mm

**VOLKMANN**  
21,5 cm, 8½"



								scharf sharp agudos pointu острые		
13-29-011-01	13-29-011-02	13-29-011-03	13-29-011-04	13-29-011-06	13-29-011-08	9 x 8 mm	15 x 15 mm	15 x 20 mm	15 x 30 mm	15 x 40 mm
								halbscharf half-sharp semi-pointu semi-agudos полуострые		
13-29-013-01	13-29-013-02	13-29-013-03	13-29-013-04	13-29-013-06	13-29-013-08	9 x 8 mm	15 x 15 mm	15 x 20 mm	15 x 30 mm	15 x 40 mm
								stumpf blunt mousse romo тупые		
13-29-012-01	13-29-012-02	13-29-012-03	13-29-012-04	13-29-012-06	13-29-012-08	9 x 8 mm	15 x 15 mm	15 x 20 mm	15 x 30 mm	15 x 40 mm

**KOCHER**  
22,0 cm, 8¾"

Wundhaken  
 Retractors  
 Ecarteurs  
 Separadores  
 Ранорасширители-крючки



26 x 40 mm  
 13-29-021-24

stumpf  
 blunt  
 mousse  
 tonto  
 тупые



26 x 40 mm  
 13-29-022-24

scharf  
 sharp  
 pointu  
 agudos  
 острые

**KOERTE**  
 24,0 cm, 9½"

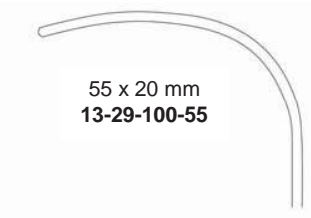

55 x 20 mm  
 13-29-100-55

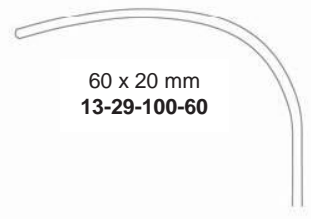

60 x 20 mm  
 13-29-100-60

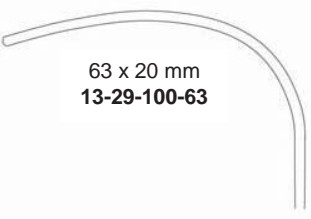

63 x 20 mm  
 13-29-100-63

**LANGENBECK**  
 21,0 cm, 8¼"

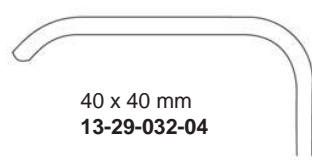

40 x 40 mm  
 13-29-032-04

4 Zähne  
 4 teeth  
 4 griffes  
 4 dientes  
 4 зубца

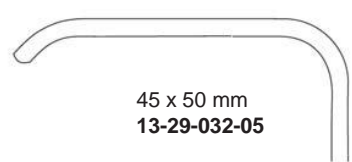

45 x 50 mm  
 13-29-032-05

5 Zähne  
 5 teeth  
 5 griffes  
 5 dientes  
 5 зубцов

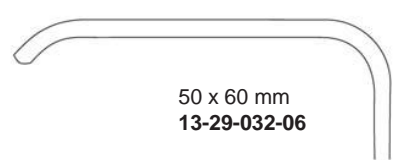

50 x 60 mm  
 13-29-032-06

6 Zähne  
 6 teeth  
 6 griffes  
 6 dientes  
 6 зубцов

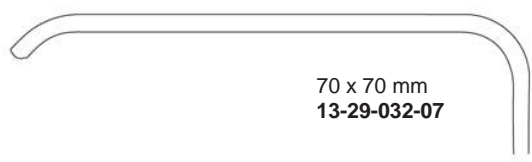

70 x 70 mm  
 13-29-032-07

6 Zähne  
 6 teeth  
 6 griffes  
 6 dientes  
 6 зубцов

**KOCHER**  
 22,0 cm, 8¾"



**LANGENBECK**  
22,0 cm, 8 $\frac{5}{16}$ "



30 x 11 mm  
13-29-110-30



30 x 14 mm  
13-29-110-31



30 x 16 mm  
13-29-110-32



33 x 14 mm  
13-29-110-33



40 x 11 mm  
13-29-110-40



42 x 13 mm  
13-29-110-42



50 x 11 mm  
13-29-110-50



**LANGENBECK**  
22,0 cm, 8 $\frac{5}{16}$ "



30 x 11 mm  
13-29-120-30



30 x 14 mm  
13-29-120-31



30 x 16 mm  
13-29-120-32



33 x 14 mm  
13-29-120-33



40 x 11 mm  
13-29-120-40

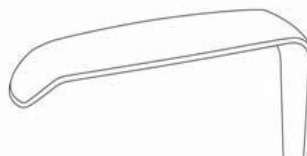

42 x 13 mm  
13-29-120-42

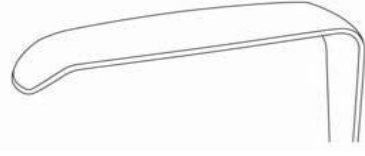

50 x 11 mm  
13-29-120-50

Wundhaken  
Retractors  
Ecarteurs  
Separadores  
Ретракторы

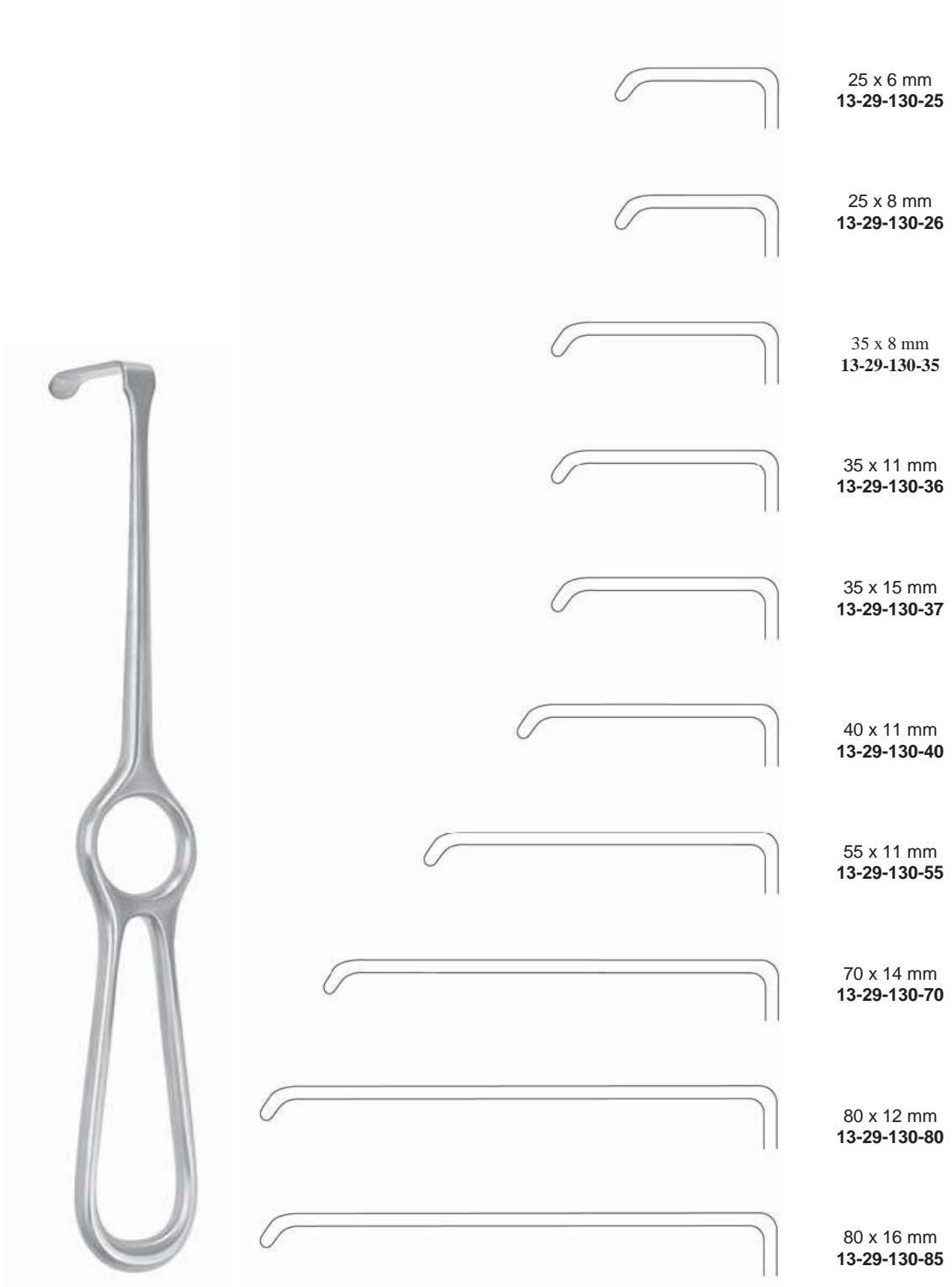

**KOCHER-LANGENBECK**  
21,5 cm, 8½"

25 x 6 mm  
13-29-130-25

25 x 8 mm  
13-29-130-26

35 x 8 mm  
13-29-130-35

35 x 11 mm  
13-29-130-36

35 x 15 mm  
13-29-130-37

40 x 11 mm  
13-29-130-40

55 x 11 mm  
13-29-130-55

70 x 14 mm  
13-29-130-70

80 x 12 mm  
13-29-130-80

80 x 16 mm  
13-29-130-85



Wundhaken  
Retractors  
Ecarteurs  
Separadores  
Ретракторы



**KOCHER**  
23,0 cm, 9"

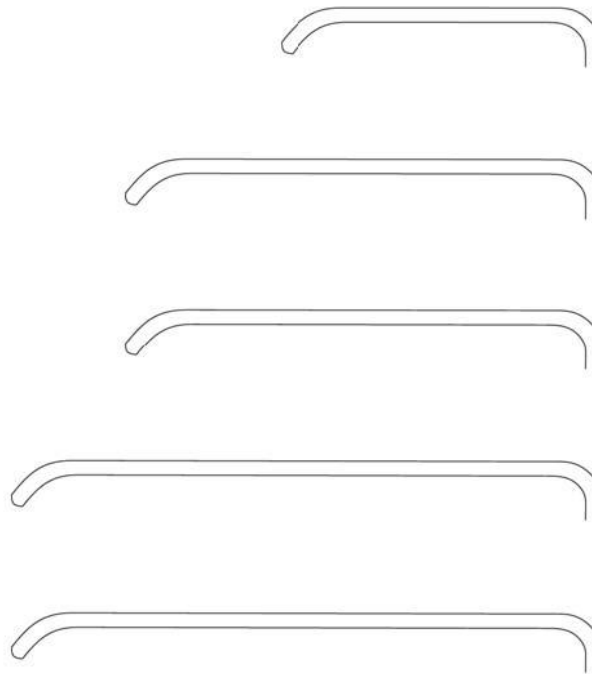

40 x 18 mm  
13-29-140-18

60 x 20 mm  
13-29-140-20

60 x 25 mm  
13-29-140-25

75 x 30 mm  
13-29-140-30

75 x 40 mm  
13-29-140-40



**SAUERBRUCH**  
22,5 cm, 8¾"

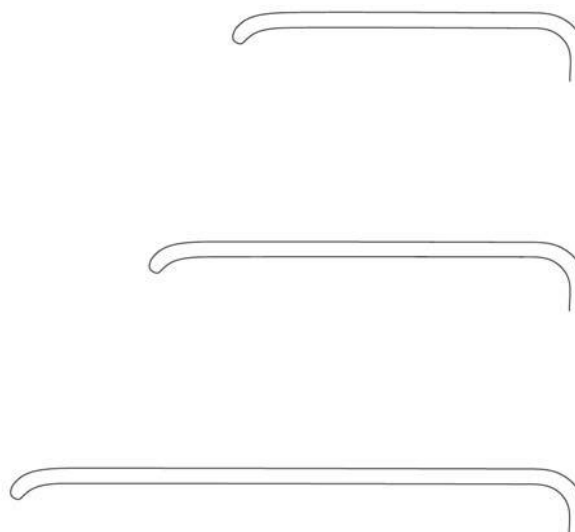

44 x 16 mm  
13-29-150-44

55 x 22 mm  
13-29-150-55

72 x 19 mm  
13-29-150-72



Wundhaken  
Retractors  
Ecarteurs  
Separadores  
Ретракторы



**MIDDELDORPF**



21,5 cm, 8½" 14 x 17 mm  
**13-29-180-01**



22,0 cm, 8⅝" 20 x 22 mm  
**13-29-180-02**



23,5 cm, 9¼" 26 x 30 mm  
**13-29-180-03**



**MIDDELDORPF**



21,5 cm, 8½" 14 x 17 mm  
**13-29-182-01**



22,0 cm, 8⅝" 20 x 22 mm  
**13-29-182-02**



23,5 cm, 9¼" 26 x 30 mm  
**13-29-182-03**



**RICHARDSON (KELLY)  
Loop Handle**



28 x 20 mm  
24,0 cm, 9½"  
**13-29-210-01**

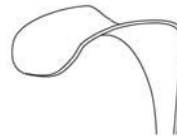

30 x 28 mm  
24,0 cm, 9½"  
**13-29-210-02**



38 x 37 mm  
24,0 cm, 9½"  
**13-29-212-03**



52 x 22 mm  
24,0 cm, 9½"  
**13-29-210-04**



50 x 40 mm  
26,0 cm, 10¼"  
**13-29-210-05**

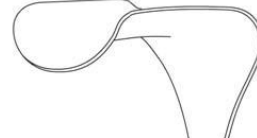

65 x 50 mm  
26,0 cm 10¼"  
**13-29-210-06**

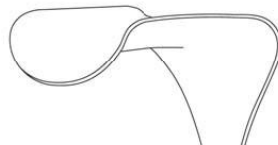

65 x 75 mm  
26,0 cm 10¼"  
**13-29-210-07**

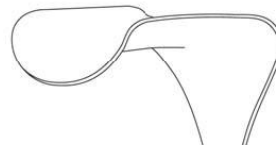

70 x 65 mm  
26,0 cm 10¼"  
**13-29-210-08**

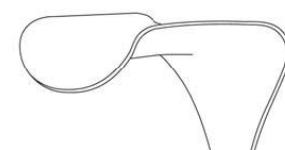

90 x 76 mm  
26,0 cm 10¼"  
**13-29-210-09**

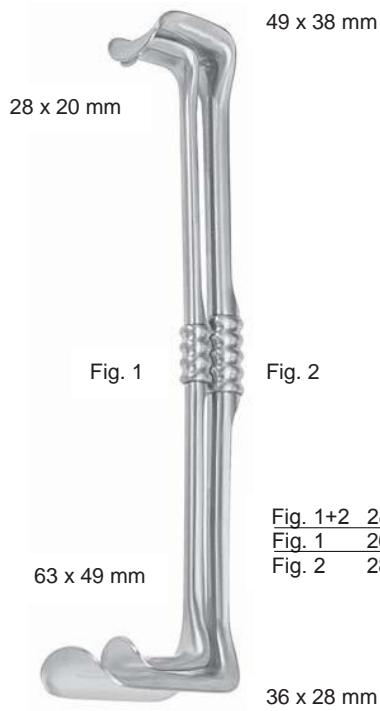
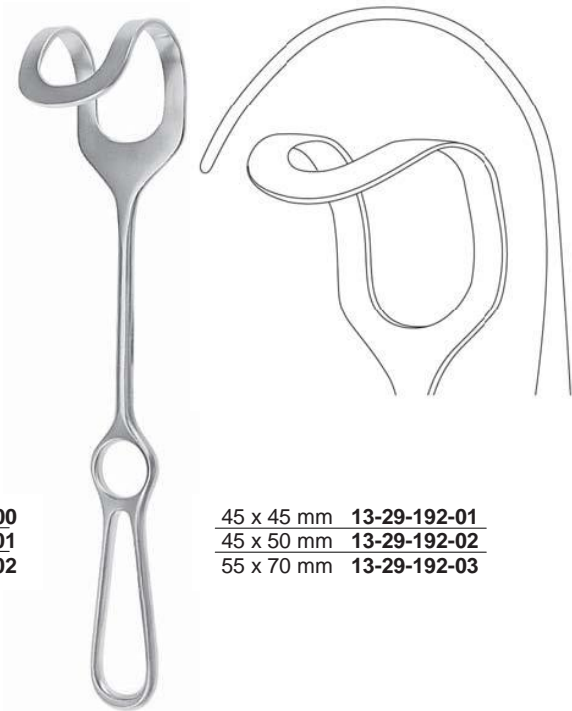

Fig. 1

Fig. 2

Fig. 1+2	28,0 cm, 11"	<b>13-28-200-00</b>
Fig. 1	26,0 cm, 10¼"	<b>13-28-200-01</b>
Fig. 2	28,0 cm, 11"	<b>13-28-200-02</b>

**RICHARDSON-EASTMAN**



**MIDDELDORPF**  
25,5 cm, 10"

45 x 45 mm	<b>13-29-192-01</b>
45 x 50 mm	<b>13-29-192-02</b>
55 x 70 mm	<b>13-29-192-03</b>



**FRITSCH**  
24,0 cm, 9½"

45 x 40 mm	<b>13-29-240-40</b>
45 x 50 mm	<b>13-29-240-50</b>
45 x 60 mm	<b>13-29-240-60</b>
55 x 75 mm	<b>13-29-240-75</b>
65 x 85 mm	<b>13-29-240-85</b>



**DOYEN**  
25,0 cm, 10"    50 x 85 mm    **13-29-230-50**  
26,0 cm, 10¼"    78 x 82 mm    **13-29-230-51**

Wundhaken  
 Retractors  
 Ecarteurs  
 Separadores  
 Ретракторы



**DOYEN-STILLE**  
 22,0 cm, 8<sup>5</sup>/<sub>8</sub>"

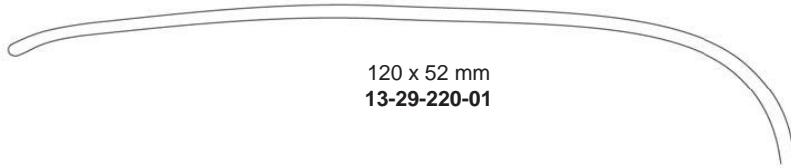

120 x 52 mm  
**13-29-220-01**

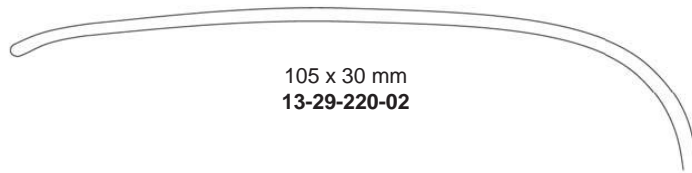

105 x 30 mm  
**13-29-220-02**



90 x 28 mm  
**13-29-220-03**

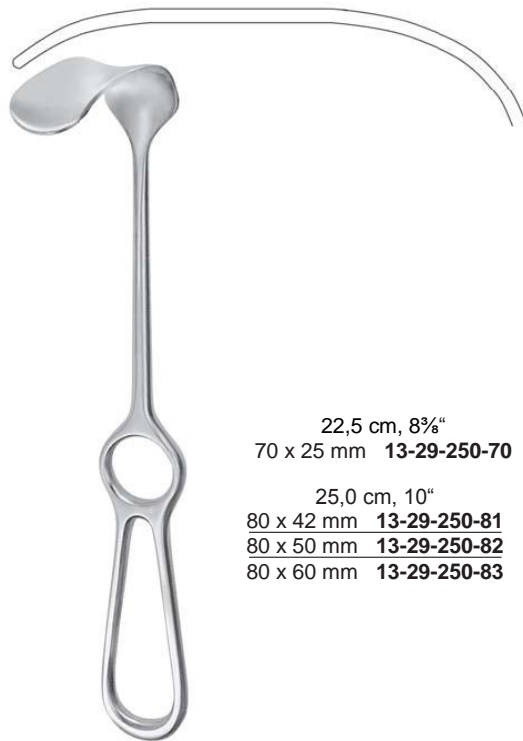

**KOCHER**

22,5 cm, 8<sup>3</sup>/<sub>8</sub>"  
 70 x 25 mm **13-29-250-70**

25,0 cm, 10"  
 80 x 42 mm **13-29-250-81**  
 80 x 50 mm **13-29-250-82**  
 80 x 60 mm **13-29-250-83**



**LAHEY**  
 19,0 cm, 7<sup>1</sup>/<sub>2</sub>"  
**13-61-160-19**

28 x 6 mm



Wundhaken  
Retractors  
Ecarteurs  
Separadores  
Ретракторы



12 x 14 mm

**LITTLE**  
20,0 cm, 8"  
1329-164-20



115 x 22 mm 13-29-260-01  
115 x 27 mm 13-29-260-02

**SIMON**  
28,0 cm, 11"



160 x 38 mm 13-29-280-61  
160 x 57 mm 13-29-280-62  
190 x 38 mm 13-29-280-91  
190 x 57 mm 13-29-280-92

**KELLY**  
27,0 cm, 10½"

Wundhaken  
Retractors  
Ecarteurs  
Separadores  
Ретракторы



185 x 35 mm **13-29-274-01**  
120 x 50 mm **13-29-274-02**  
155 x 50 mm **13-29-274-03**

**MIKULICZ**  
26,0 cm, 10¼"

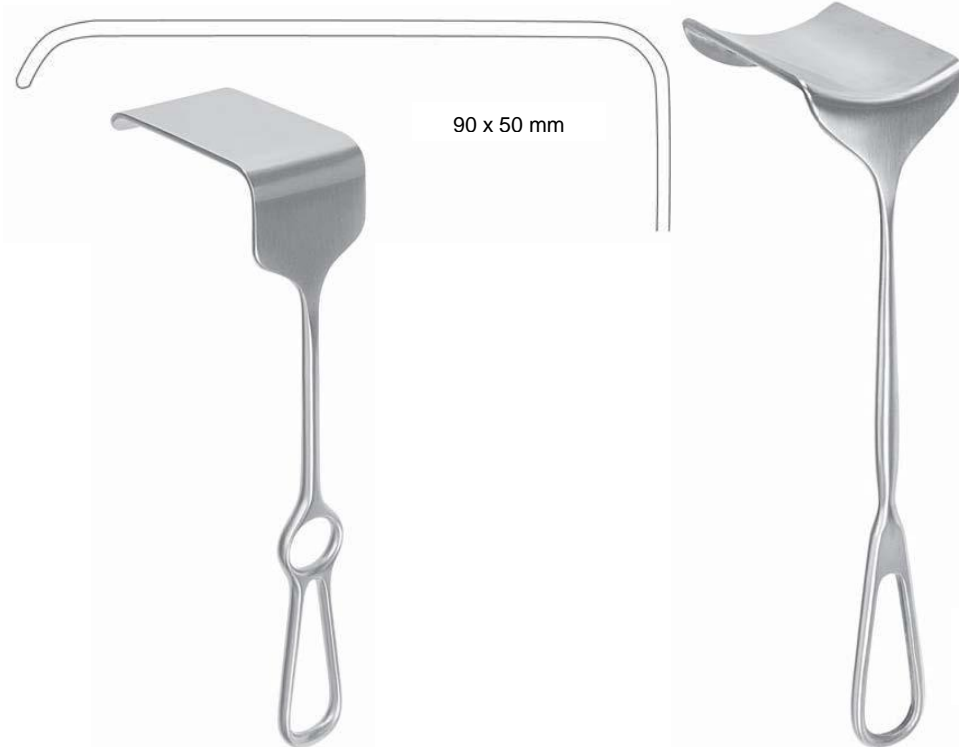

90 x 50 mm

70 x 38 mm **13-29-290-38**  
70 x 50 mm **13-29-290-50**  
70 x 65 mm **13-29-290-65**

**MIKULICZ**  
26,0 cm, 10¼"  
**13-29-272-90**

**MORRIS**  
24,5 cm, 9⅝"

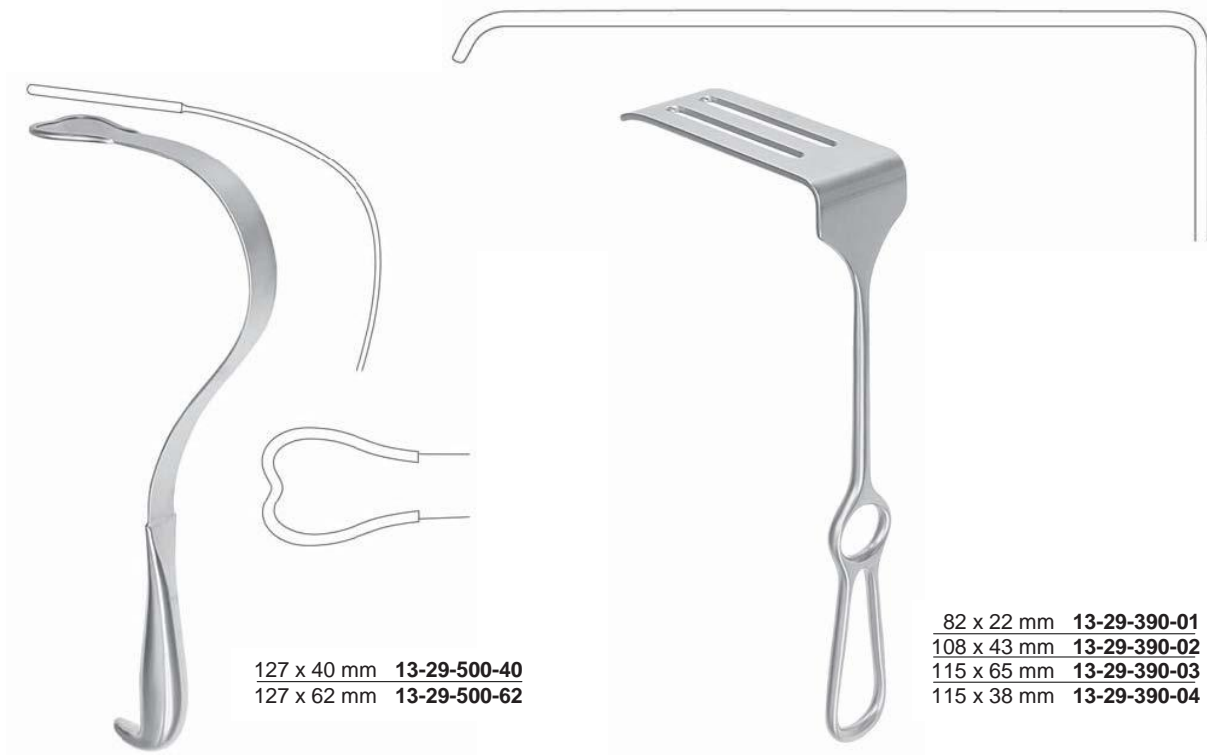

127 x 40 mm 13-29-500-40  
127 x 62 mm 13-29-500-62

82 x 22 mm 13-29-390-01  
108 x 43 mm 13-29-390-02  
115 x 65 mm 13-29-390-03  
115 x 38 mm 13-29-390-04

**HARRINGTON**  
32,0 cm, 12½"

**CORYKKOS**  
24,0 cm, 9½"



29,0 cm, 11¼", 120 x 12 mm  
13-29-320-28

25,0 cm, 9¾", 75 x 12 mm  
13-29-320-25

26,0 cm, 10¼", 60 x 12 mm  
13-29-320-26

27,5 cm, 10¾", 35 x 8 mm  
13-29-320-27

**ZENKER**

Wundhaken  
Retractors  
Ecarteurs  
Separadores  
Ретракторы



**MEYERDING**  
22,5 cm, 8¾"

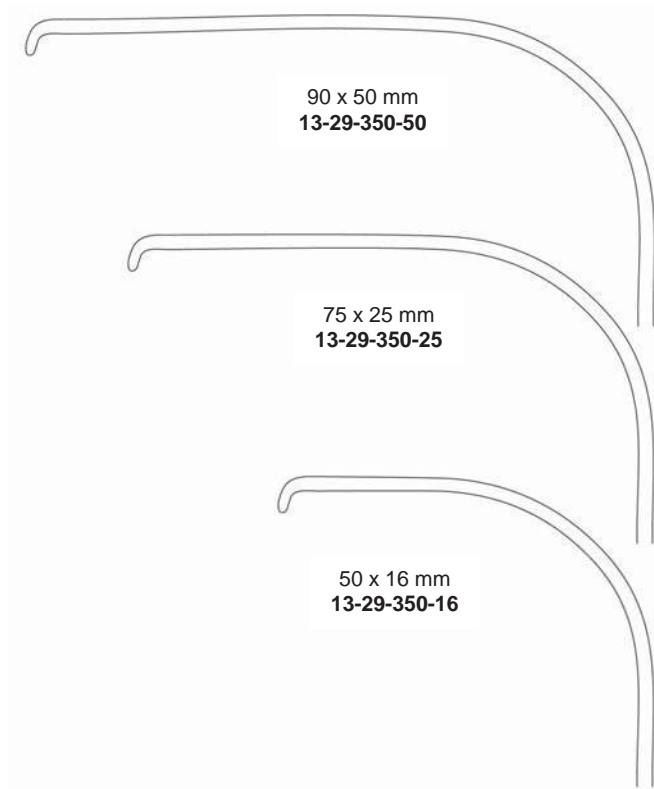

90 x 50 mm  
13-29-350-50

75 x 25 mm  
13-29-350-25

50 x 16 mm  
13-29-350-16



**BRUNNER**  
25,0 cm, 10"

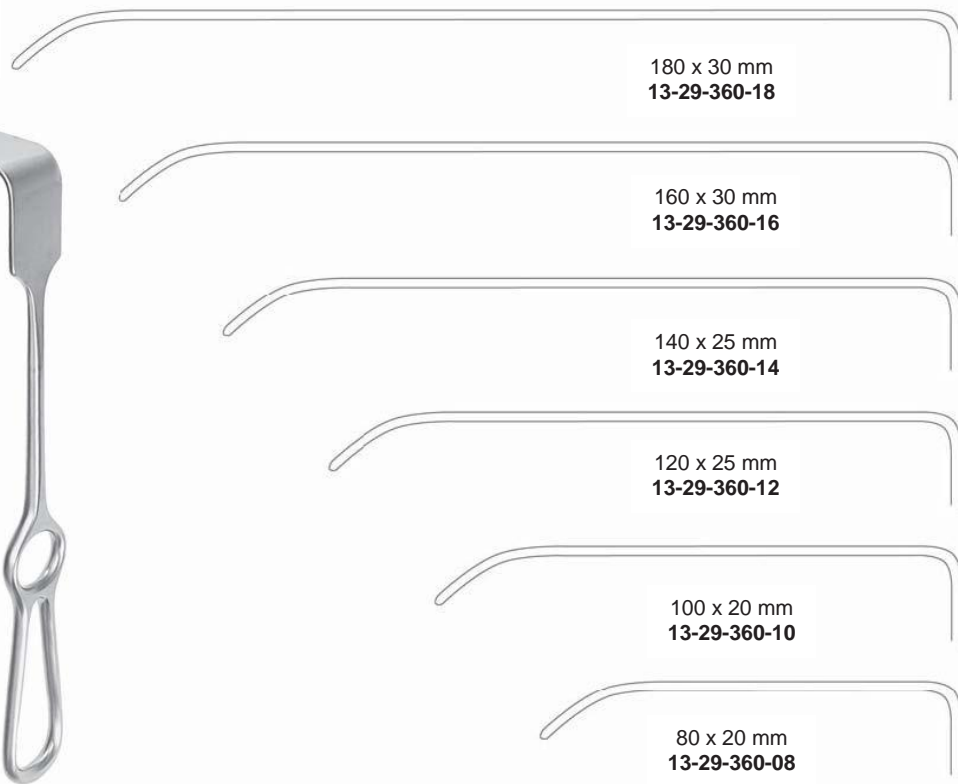

180 x 30 mm  
13-29-360-18

160 x 30 mm  
13-29-360-16

140 x 25 mm  
13-29-360-14

120 x 25 mm  
13-29-360-12

100 x 20 mm  
13-29-360-10

80 x 20 mm  
13-29-360-08

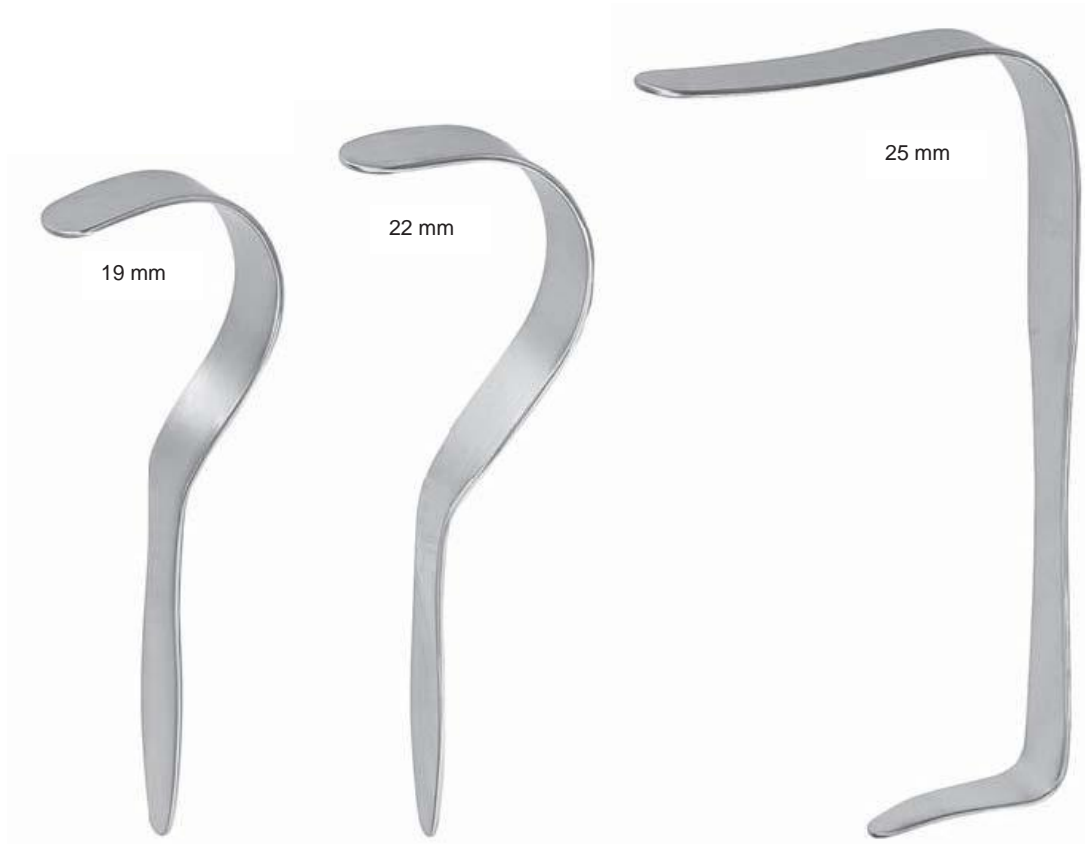

**DEAVER**  
18,0 cm, 7"  
13-29-602-19

**DEAVER**  
21,5 cm, 8½"  
13-29-602-22

**DEAVER**  
23,0 cm, 9"  
13-29-602-25



Wundhaken  
Retractors  
Ecarteurs  
Separadores  
Ретракторы



25 mm

**DEAVER**  
30,0 cm, 11 $\frac{3}{4}$ "  
13-29-604-30



25 mm

**DEAVER**  
33,0 cm, 13"  
13-29-604-33



25 mm

**DEAVER**  
36,0 cm, 14 $\frac{1}{8}$ "  
13-29-604-36



38 mm

**DEAVER**  
30,0 cm, 11 $\frac{3}{4}$ "  
13-29-610-38



50 mm

**DEAVER**  
30,0 cm, 11 $\frac{3}{4}$ "  
13-29-610-50



75 mm

**DEAVER**  
30,0 cm, 11 $\frac{3}{4}$ "  
13-29-610-75



25 mm	13-29-600-25
38 mm	13-29-600-38
50 mm	13-29-600-50
75 mm	13-29-600-75
100 mm	13-29-600-76

**DEAVER GRIP**  
30,0 cm, 11¾"



40 mm	30,0 cm, 11¾"	13-29-700-30
54 mm	32,0 cm, 12½"	13-29-700-32

**ALLISON**



75 x 50 mm	16,0 cm, 6¼"	13-29-710-50
75 x 90 mm	16,0 cm, 6¼"	13-29-710-90

**DAVIDSON**



**ST. MARKS**

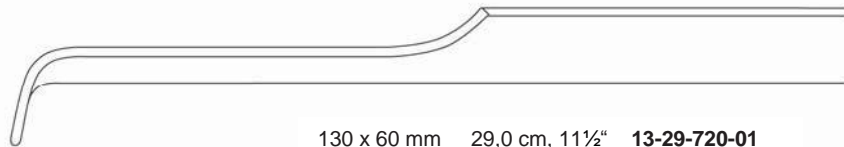

130 x 60 mm	29,0 cm, 11½"	13-29-720-01
180 x 60 mm	33,0 cm, 13"	13-29-720-02



33,0 cm, 13" 180 x 60 mm 13-29-721-02



Leicht  
Medizintechnik

**Wundspreizer**  
**Self-Retaining Retractors**  
**Ecarteurs autostatiques**  
**Separadores con retenida automática**  
**Самоудерживающиеся ранорасширители**







Wundspreizer  
 Self-Retaining Retractors  
 Ecarteurs autostatiques  
 Separadores con retenida automática  
 Самоудерживающиеся ранорасширители



5,0 cm, 2"  
 15-30-610-05

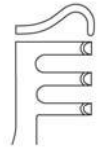

5,0 cm, 2"  
 15-30-611-05

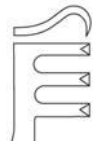

7,0 cm, 2¾"  
 15-30-610-07

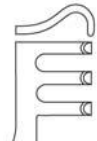

7,0 cm, 2¾"  
 15-30-611-07



FINSEN

scharf  
 sharp  
 pointu  
 agudos  
 острые

stumpf  
 blunt  
 mousse  
 romo  
 тупые



JANSEN  
 10,0 cm, 4"

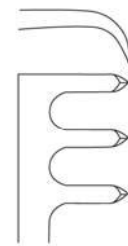

15-30-630-10

scharf  
 sharp  
 pointu  
 agudos  
 острые

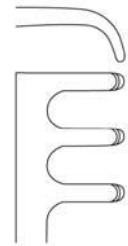

15-30-631-10

stumpf  
 blunt  
 mousse  
 romo  
 тупые



ALM

scharf  
 sharp  
 pointu  
 agudos  
 острые

halbscharf  
 semi-sharp  
 semi-pointu  
 semi-agudos  
 полуострые

stumpf  
 blunt  
 mousse  
 romo  
 тупые



7,0 cm, 2¾" 15-30-620-07 15-30-622-07 15-30-621-07  
 10,0 cm, 4" 15-30-620-10 15-30-622-10 15-30-621-10



ALLPORT  
 9,5 cm, 3¾"  
 15-30-626-09

Wundspreizer  
 Self-Retaining Retractors  
 Ecarteurs autostatiques  
 Separadores con retenida automática  
 Самоудерживающиеся ранорасширители

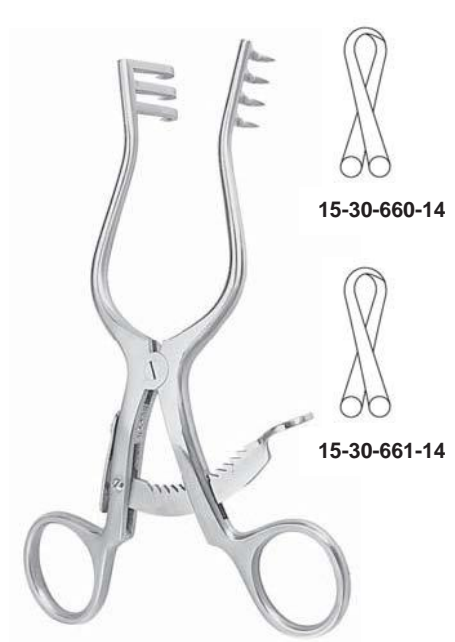

scharf  
sharp  
pointu  
agudos  
острые

15-30-660-14

stumpf  
blunt  
mousse  
romo  
тупые

15-30-661-14

**SALP-CONTOUR**  
14,0 cm, 5½"



scharf  
sharp  
pointu  
agudos  
острые

13,0 cm, 5" **15-30-684-13**  
16,0 cm, 6¼" **15-30-684-16**

stumpf  
blunt  
mousse  
romo  
тупые

13,0 cm, 5" **15-30-685-13**  
16,0 cm, 6¼" **15-30-685-16**

**ADSON-BABY**

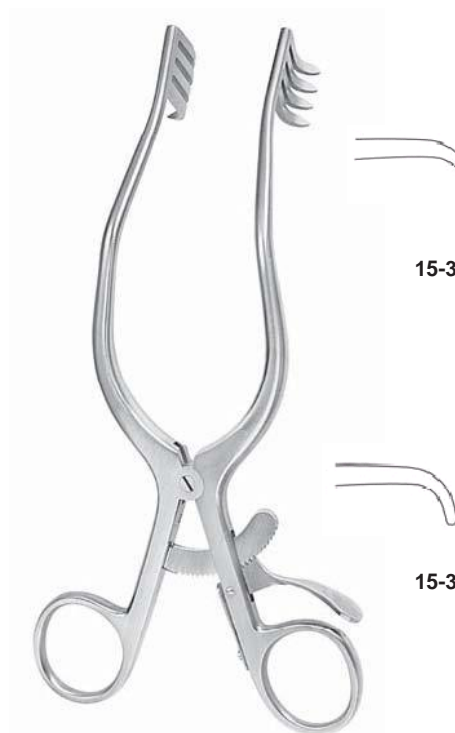

scharf  
sharp  
pointu  
agudos  
острые

15-30-678-20

stumpf  
blunt  
mousse  
romo  
тупые

15-30-679-20

**ANDERSON-ADSON**  
20,0 cm, 8"



scharf  
sharp  
pointu  
agudos  
острые

26,5 cm, 10½" **15-30-682-26**  
32,0 cm, 12½" **15-30-682-32**

stumpf  
blunt  
mousse  
romo  
тупые

26,5 cm, 10½" **15-30-683-26**  
32,0 cm, 12½" **15-30-683-32**

**ADSON**



Wundspreizer  
 Self-Retaining Retractors  
 Ecarteurs automatiques  
 Separadores con retenida automática  
 Самоудерживающиеся ранорасширители

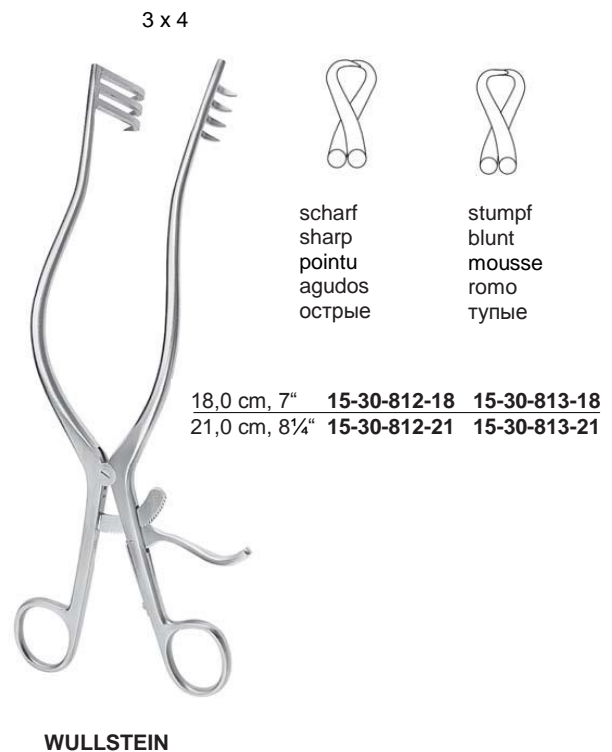
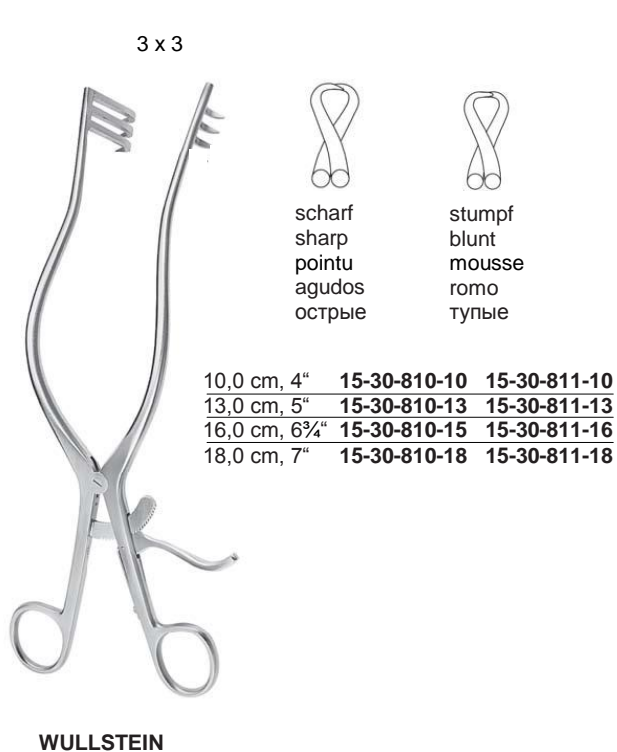
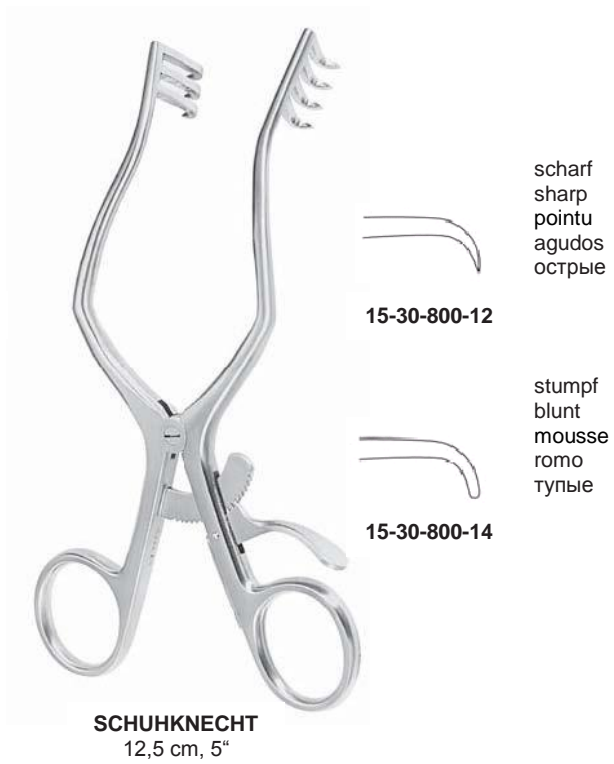

Wundspreizer  
Self-Retaining Retractors  
Ecarteurs autostatiques  
Separadores con retenida automática  
Самоудерживающиеся ранорасширители



**MAYO-ADAMS**  
16,5 cm, 6½"  
15-30-822-17



mit Mittelblatt  
with central blade  
avec valve centrale  
con valve central  
с центральной лопаткой

**MAYO-ADAMS**  
17,0 cm, 6¾"  
15-30-320-17





Wundspreizer  
Self-Retaining Retractors  
Ecarteurs autostatiques  
Separadores con retenida automática  
Самоудерживающиеся ранорасширители



**WEITLANER-LOKTITE**  
10,5 cm, 4 $\frac{1}{8}$ "

15-30-650-10



scharf  
sharp  
pointu  
agudos  
острые



15-30-651-10

stumpf  
blunt  
mousse  
romo  
тупые



**WEITLANER**

10,5 cm, 4 $\frac{1}{8}$ " **15-30-670-10**  
13,0 cm, 5" **15-30-670-13**



scharf  
sharp  
pointu  
agudos  
острые



10,5 cm, 4 $\frac{1}{8}$ " **1530-671-10**  
13,0 cm, 5" **1530-671-13**

stumpf  
blunt  
mousse  
romo  
тупые



**WEITLANER**  
16,5 cm, 6 $\frac{1}{2}$ "

15-30-670-16



scharf  
sharp  
pointu  
agudos  
острые



15-30-671-16

stumpf  
blunt  
mousse  
romo  
тупые



**WEITLANER**  
20,0 cm, 8"

15-30-670-20



scharf  
sharp  
pointu  
agudos  
острые



15-30-671-20

stumpf  
blunt  
mousse  
romo  
тупые

Wundspreizer  
 Self-Retaining Retractors  
 Ecarteurs autostatiques  
 Separadores con retenida automática  
 Самоудерживающиеся ранорасширители



**WEITLANER**  
 26,0 cm, 10¼"

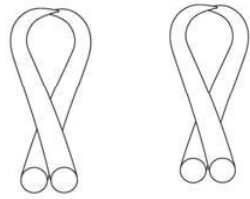

scharf  
 sharp  
 pointu  
 agudos  
 острые

stumpf  
 blunt  
 mousse  
 romo  
 тупые

**3 x 4**  
 15-30-670-34 15-30-671-34

**5 x 6**  
 15-30-670-56 15-30-671-56



**PLESTER**



scharf  
 sharp  
 pointu  
 agudos  
 острые

10,0 cm, 4" **15-30-830-10**  
 13,0 cm, 5" **15-30-830-13**



stumpf  
 blunt  
 mousse  
 romo  
 тупые

10,0 cm, 4" **15-30-831-10**  
 13,0 cm, 5" **15-30-831-13**



**MILLIGAN**  
 13,0 cm, 5"

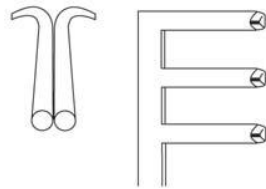

**15-30-840-13 15-30-841-13**

stumpf  
 blunt  
 mousse  
 romo  
 тупые

scharf  
 sharp  
 pointu  
 agudos  
 острые



**PLESTER**  
 11,0 cm, 4¾"  
**15-30-672-11**

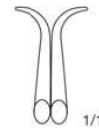
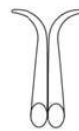

**PLESTER**  
 11,0 cm, 4¾"  
**15-30-673-11**



Wundspreizer  
 Self-Retaining Retractors  
 Ecarteurs automatiques  
 Separadores con retenida automática  
 Самоудерживающиеся ранорасширители



**WEITLANER-BABY**  
 13,0 cm, 5"  
 15-30-850-13



**ADSON  
 (CONE)**

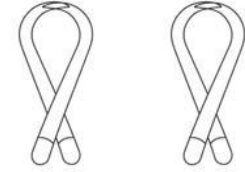

13,0 cm, 5"	<b>15-30-860-13</b>	<b>15-30-861-13</b>
16,0 cm, 6 <sup>3</sup> / <sub>4</sub> "	<b>15-30-860-16</b>	<b>15-30-861-16</b>
20,0 cm, 8"	<b>15-30-860-20</b>	<b>15-30-861-20</b>
26,0 cm, 10 <sup>1</sup> / <sub>4</sub> "	<b>15-30-860-26</b>	<b>15-30-861-26</b>

scharf	stumpf
sharp	blunt
pointu	mousse
agudos	romo
острые	тупые

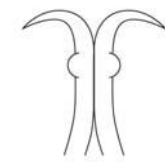

**GELPI**  
 9,0 cm, 3<sup>1</sup>/<sub>2</sub>" **15-30-202-09**  
 11,0 cm, 4<sup>3</sup>/<sub>4</sub>" **15-30-202-11**  
 13,0 cm, 5" **15-30-202-13**  
 19,0 cm, 7<sup>1</sup>/<sub>2</sub>" **15-30-202-19**



**GELPI**

stumpf  
 blunt  
 mousse  
 romo  
 тупые  
 15,0 cm, 6" **15-30-205-15**

scharf  
 sharp  
 pointu  
 agudos  
 острые  
 15,0 cm, 6" **15-30-204-15**  
 17,0 cm, 6<sup>3</sup>/<sub>4</sub>" **15-30-204-17**



**GELPI-LOKTITE**  
 18,0 cm, 7"  
**15-30-250-19**

Wundspreizer  
 Self-Retaining Retractors  
 Ecarteurs autostatiques  
 Separadores con retenida automática  
 Самоудерживающиеся ранорасширители

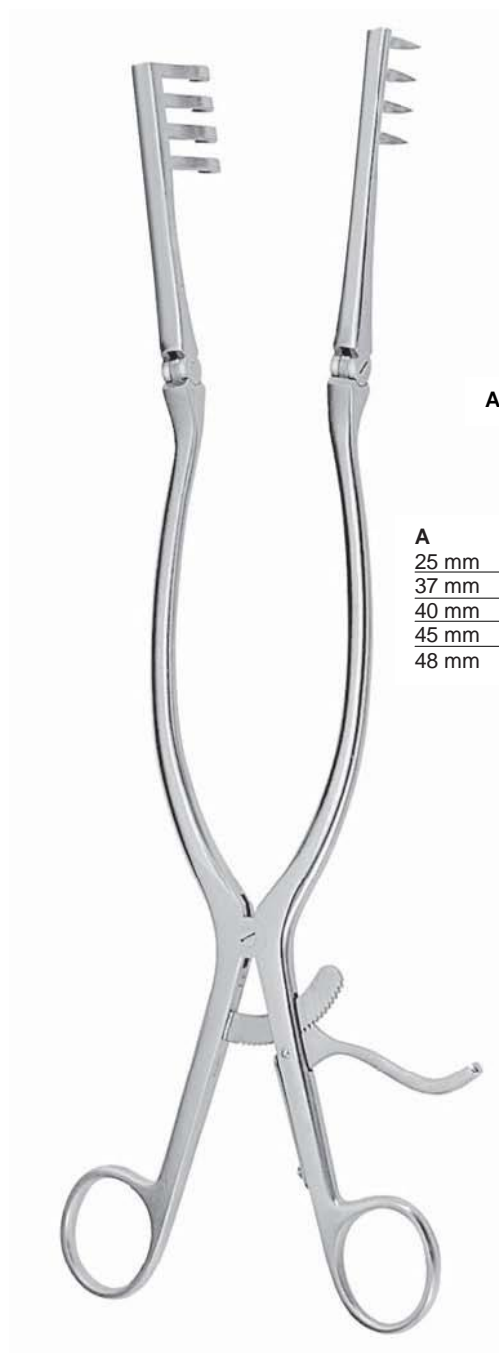

**BECKMANN-ADSON**  
 31,0 cm, 12¼"

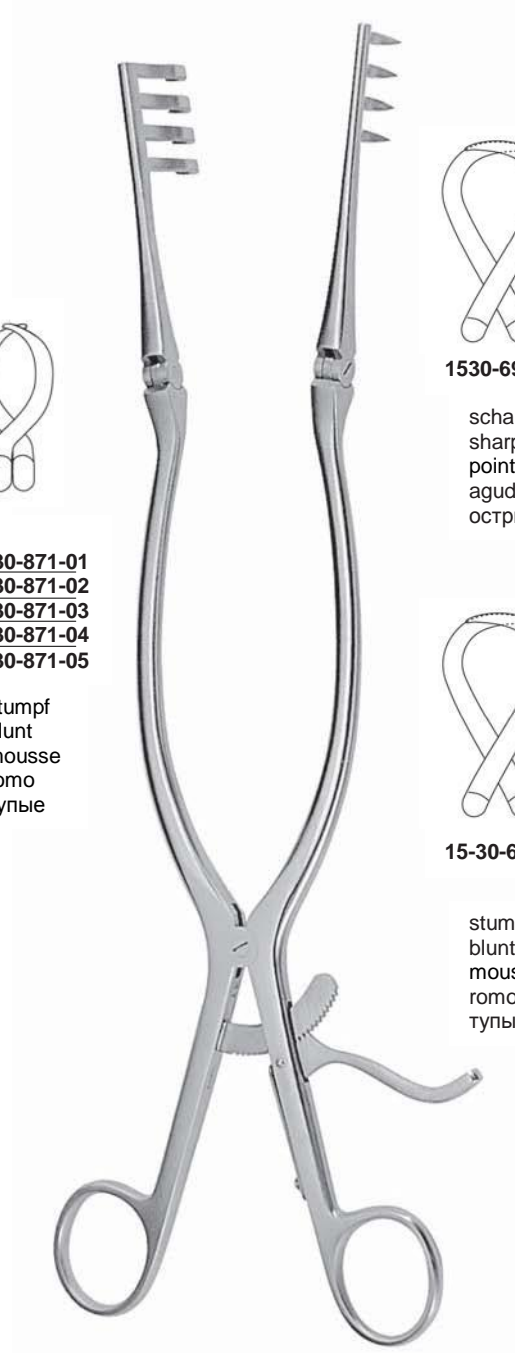

**BECKMANN**  
 31,0 cm, 12¼"

A

A		
25 mm	15-30-870-01	15-30-871-01
37 mm	15-30-870-02	15-30-871-02
40 mm	15-30-870-03	15-30-871-03
45 mm	15-30-870-04	15-30-871-04
48 mm	15-30-870-05	15-30-871-05

scharf	stumpf
sharp	blunt
pointu	mousse
agudos	romo
острые	тупые



1530-690-31

scharf  
 sharp  
 pointu  
 agudos  
 острые



15-30-691-31

stumpf  
 blunt  
 mousse  
 romo  
 тупые



Wundspreizer  
Self-Retaining Retractors  
Ecarteurs autostatiques  
Separadores con retenida automática  
Самоудерживающиеся ранорасширители



**BECKMANN**  
33,0 cm, 12½"



15-30-691-32

stumpf  
blunt  
mousse  
ром  
тупые



15-30-690-32

scharf  
sharp  
pointu  
agudos  
острые



**DE BAKEY**

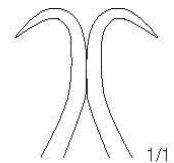

10,0 cm, 4" **15-30-240-10**  
14,0 cm, 5½" **15-30-240-14**

Wundspreizer  
 Self-Retaining Retractors  
 Ecarteurs autostatiques  
 Separadores con retenida automática  
 Самоудерживающиеся ранорасширители

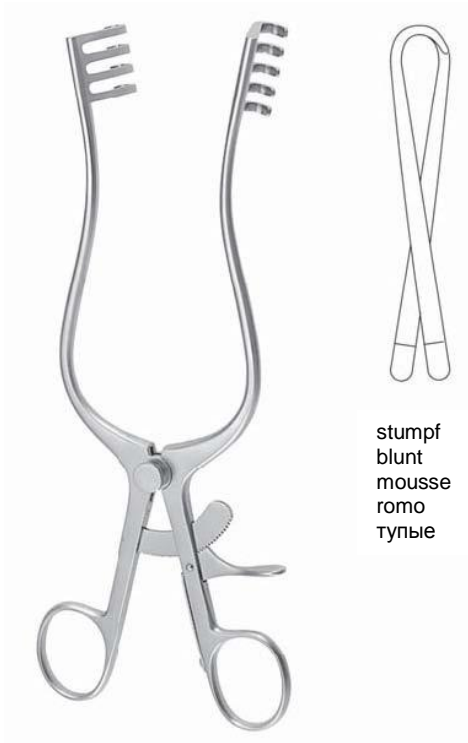

stumpf  
 blunt  
 mousse  
 romo  
 тупые

**NORFOLK AND NORWICH**  
 22,0 cm, 8<sup>5</sup>/<sub>8</sub>"  
 15-30-401-22

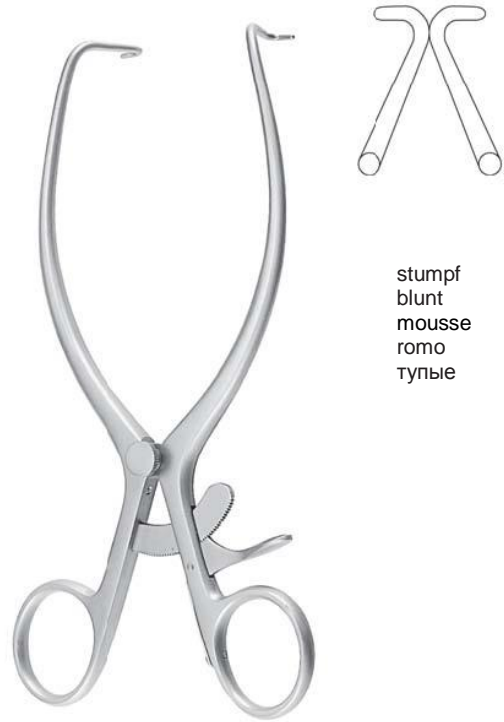

stumpf  
 blunt  
 mousse  
 romo  
 тупые

**JACKSON BURROWS**  
 17,5 cm, 7"  
 15-30-411-17



**RICHTER**  
 17,0 cm, 6<sup>3</sup>/<sub>4</sub>"  
 15-30-420-17



**JOLL (FRIEDMAN)**  
 15,5 cm, 6"  
 15-30-430-15



Wundspreizer  
Self-Retaining Retractors  
Ecarteurs autostatiques  
Separadores con retenida automática  
Самоудерживающиеся ранорасширители



**HENLEY**  
16,0 cm, 6¼"  
15-30-300-00

scharf  
sharp  
pointu  
agudos  
острые

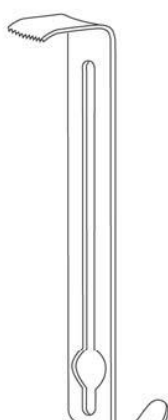

19 x 16 mm  
15-30-300-19

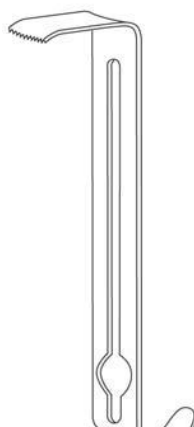

25 x 16 mm  
15-30-300-25

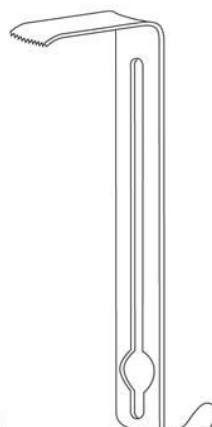

32 x 16 mm  
15-30-300-32

stumpf  
blunt  
mousse  
romos  
тупые



**HENLEY**  
16,0 cm, 6¼"  
15-30-301-00

**komplett, bestehend aus:**

- 1 Sperrer mit Seitenvalven, scharf (1530-300-18)
- 1 Mittelvalve 19 x 16 mm (1530-300-19)
- 1 Mittelvalve 25 x 16 mm (1530-300-25)
- 1 Mittelvalve 32 x 16 mm (1530-300-32)

**complete, consisting of:**

- 1 Spreader with lateral valves, sharp (1530-0300-18)
- 1 Central valve 19 x 16 mm (1530-300-19)
- 1 Central valve 25 x 16 mm (1530-300-25)
- 1 Central valve 32 x 16 mm (1530-300-32)

**complet consistant de:**

- 1 écarteur avec valves latérales, pointu (1530-300-18)
- 1 valve central 19 x 16 mm (1530-300-19)
- 1 valve central 25 x 16 mm (1530-300-25)
- 1 valva central 32 x 16 mm (1530-300-32)

**completo, compuesto of:**

- 1 Separadorcon valvas laterales, agudas (1530-300-18)
- 1 Valva central 19 x 16 mm (1530-300-19)
- 1 Valva central 25 x 16 mm (1530-300-25)
- 1 Valva central 32 x 16 mm (1530-300-32)

**КОМПЛЕКТ СОСТОИТ ИЗ:**

- 1 расширитель с боковыми шпателями, острые (1530-300-18)
- 1 центральный шпатель 19 x 16 мм (1530-300-19)
- 1 центральный шпатель 25 x 16 мм (1530-300-25)
- 1 центральный шпатель 32 x 16 мм (1530-300-32)

**komplett, bestehend aus:**

- 1 Sperrer mit Seitenvalven, stumpf (1530-301-18)
- 1 Mittelvalve 19 x 16 mm (1530-300-19)
- 1 Mittelvalve 25 x 16 mm (1530-300-25)
- 1 Mittelvalve 32 x 16 mm (1530-300-32)

**complete, consisting of:**

- 1 Spreader with lateral valves, blunt (1530-301-18)
- 1 Central valve 19 x 16 mm (1530-300-19)
- 1 Central valve 25 x 16 mm (1530-300-25)
- 1 Central valve 32 x 16 mm (1530-300-32)

**complet consistant de:**

- 1 écarteur avec valves latérales, mousse (1530-301-18)
- 1 valve central 19 x 16 mm (1530-300-19)
- 1 valve central 25 x 16 mm (1530-300-25)
- 1 valva central 32 x 16 mm (1530-300-32)

**completo, compuesto of:**

- 1 Separadorcon valvas laterales, romas (30-301-18)
- 1 Valva central 19 x 16 mm (1530-300-19)
- 1 Valva central 25 x 16 mm (1530-300-25)
- 1 Valva central 32 x 16 mm (1530-300-32)

**КОМПЛЕКТ СОСТОИТ ИЗ:**

- 1 расширитель с боковыми шпателями, тупые (1530-301-18)
- 1 центральный шпатель 19 x 16 мм (1530-300-19)
- 1 центральный шпатель 25 x 16 мм (1530-300-25)
- 1 центральный шпатель 32 x 16 мм (1530-300-32)

- 15-30-300-18** Sperrer mit Seitenvalven 18 mm, scharf / Spreader with lateral valves 18 mm, sharp / Separadorcon valvas laterales 18 mm, agudas / écarteur avec valves latérales 18 mm, pointu / расширитель с боковыми шпателями 18 mm, острые
- 15-30-300-27** Sperrer mit Seitenvalven 27 mm, scharf / Spreader with lateral valves 27 mm, sharp / Separadorcon valvas laterales 27 mm, agudas / écarteur avec valves latérales 27 mm, pointu / расширитель с боковыми шпателями 27 mm, острые
- 15-30-300-58** Sperrer mit Seitenvalven 58 mm, scharf / Spreader with lateral valves 58 mm, sharp / Separadorcon valvas laterales 58 mm, agudas / écarteur avec valves latérales 58 mm, pointu / расширитель с боковыми шпателями 58 mm, острые
- 15-30-301-18** Sperrer mit Seitenvalven 18 mm, stumpf / Spreader with lateral valves 18 mm, blunt / Separadorcon valvas laterales 18 mm, romas / écarteur avec valves latérales 18 mm, mousse / расширитель с боковыми шпателями 18 mm, тупые
- 15-30-301-27** Sperrer mit Seitenvalven 27 mm, stumpf / Spreader with lateral valves 27 mm, blunt / Separadorcon valvas laterales 27 mm, romas / écarteur avec valves latérales 27 mm, mousse / расширитель с боковыми шпателями 27 mm, тупые
- 15-30-301-58** Sperrer mit Seitenvalven 58 mm, stumpf / Spreader with lateral valves 58 mm, blunt / Separadorcon valvas laterales 58 mm, romas / écarteur avec valves latérales 58 mm, mousse / расширитель с боковыми шпателями 58 mm, тупые

Wundspreizer  
 Self-Retaining Retractors  
 Ecarteurs autostatiques  
 Separadores con retenida automática  
 Самоудерживающиеся ранорасширители



**CLOWARD Modif.**  
 25,0 cm, 10"  
 15-72-460-00



15-72-461-25



15-72-461-25Z

**15-72-460-00 Cloward** **Spreizer Set** komplett mit 14 Valven, 25 cm  
**RetractorSet** complete with 14 blades, 25 cm  
**Ecarteurs autostatiques** complet avec 14 valves, 25 cm  
**Separadores con retenida automatic** completo 14 valvas, 25 cm  
**Самоудерживающийся ранорасширитель** в комплекте с 14 лопатками, 25 см

**15-72-460-01 Sperrer allein / Spreader only / écarteur seul / Ecarteur suelto / только рамка**

**15-72-461-25 Valven** 25 mm, stumpf / blades 25 mm, blunt / valves 25 mm, mousse / Valvas 25 mm / сменные лопатки 25 mm, тупые  
**15-72-461-25Z Valven** 25 mm, scharf / blades 25 mm, sharp / valves 25 mm, pointu / Valvas 25 mm / сменные лопатки 25 mm, острые

**15-72-461-30 Valven** 30 mm, stumpf / blades 30 mm, blunt / valves 30 mm, mousse / Valvas 30 mm / сменные лопатки 30 mm, тупые  
**15-72-461-30Z Valven** 30 mm, scharf / blades 30 mm, sharp / valves 30 mm, pointu / Valvas 30 mm / сменные лопатки 30 mm, острые

**15-72-461-35 Valven** 35 mm, stumpf / blades 35 mm, blunt / valves 35 mm, mousse / Valvas 35 mm / сменные лопатки 35 mm, тупые  
**15-72-461-35Z Valven** 35 mm, scharf / blades 35 mm, sharp / valves 35 mm, pointu / Valvas 35 mm / сменные лопатки 35 mm, острые

**15-72-461-40 Valven** 40 mm, stumpf / blades 40 mm, blunt / valves 40 mm, mousse / Valvas 40 mm / сменные лопатки 40 mm, тупые  
**15-72-461-40Z Valven** 40 mm, scharf / blades 40 mm, sharp / valves 40 mm, pointu / Valvas 40 mm / сменные лопатки 40 mm, острые

**15-72-461-45 Valven** 45 mm, stumpf / blades 45 mm, blunt / valves 45 mm, mousse / Valvas 45 mm / сменные лопатки 45 mm, тупые  
**15-72-461-45Z Valven** 45 mm, scharf / blades 45 mm, sharp / valves 45 mm, pointu / Valvas 45 mm / сменные лопатки 45 mm, острые

**15-72-461-50 Valven** 50 mm, stumpf / blades 50 mm, blunt / valves 50 mm, mousse / Valvas 50 mm / сменные лопатки 50 mm, тупые  
**15-72-461-50Z Valven** 50 mm, scharf / blades 50 mm, sharp / valves 50 mm, pointu / Valvas 50 mm / сменные лопатки 50 mm, острые

**15-72-461-55 Valven** 55 mm, stumpf / blades 55 mm, blunt / valves 55 mm, mousse / Valvas 55 mm / сменные лопатки 55 mm, тупые  
**15-72-461-55Z Valven** 55 mm, scharf / blades 55 mm, sharp / valves 55 mm, pointu / Valvas 55 mm / сменные лопатки 55 mm, острые



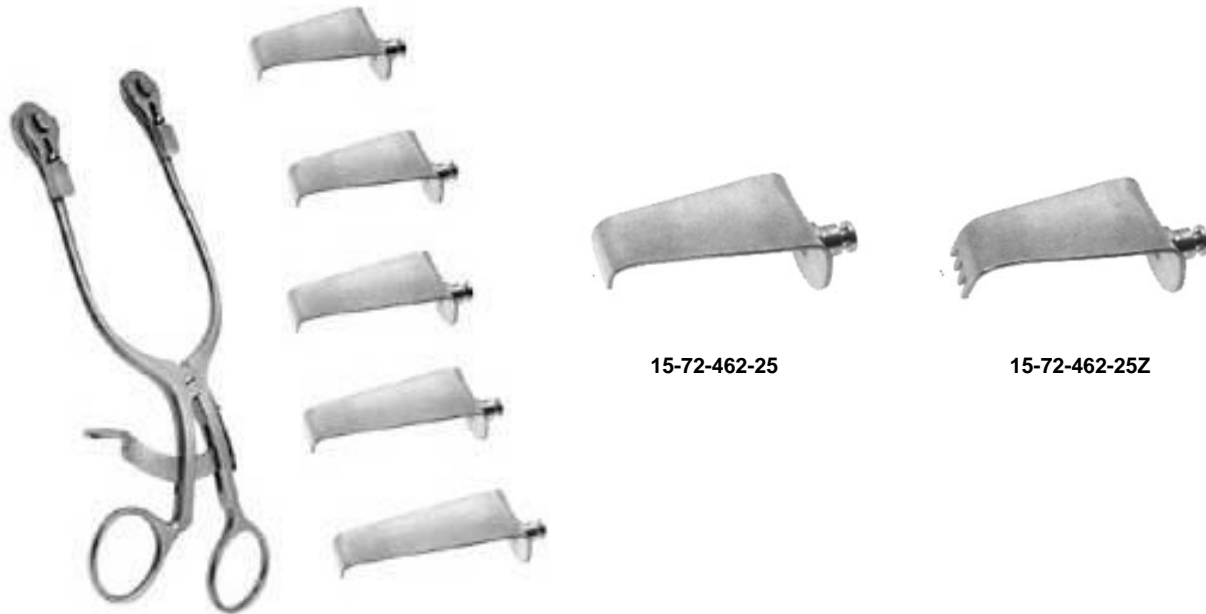

**CLOWARD Modif**  
16,5 cm, 6 1/2"  
15-72-465-00

15-72-462-25

15-72-462-25Z

- 15-72-465-00 Cloward** **Spreizer Set** komplett mit 14 Valven, 16,5 cm  
**Retractor Set** complete with 14 blades, 16,5 cm  
**Ecarteurs autostatiques** complet avec 14 valves 16,5 cm  
**Separadores con retenida automatic** completo 14 valvas, 16,5 cm  
**Самоудерживающийся ранорасширитель** в комплекте с 14 лопатками, 16,5 см

**15-72-465-01 Sperrer allein / Spreader only / écarteur seul / Ecarteur suelto / только рамка**

- 15-72-462-25 Valven** 25 mm, stumpf / blades 25 mm, blunt / valves 25 mm, mousse / Valvas 25 mm / сменные лопатки 25 mm, тупые  
**1572-462-25Z Valven** 25 mm, scharf / blades 25 mm, sharp / valves 25 mm, pointu / Valvas 25 mm / сменные лопатки 25 mm, острые
- 15-72-462-30 Valven** 30 mm, stumpf / blades 30 mm, blunt / valves 30 mm, mousse / Valvas 30 mm / сменные лопатки 30 mm, тупые  
**15-72-462-30Z Valven** 30 mm, scharf / blades 30 mm, sharp / valves 30 mm, pointu / Valvas 30 mm / сменные лопатки 30 mm, острые
- 15-72-462-35 Valven** 35 mm, stumpf / blades 35 mm, blunt / valves 35 mm, mousse / Valvas 35 mm / сменные лопатки 35 mm, тупые  
**15-72-462-35Z Valven** 35 mm, scharf / blades 35 mm, sharp / valves 35 mm, pointu / Valvas 35 mm / сменные лопатки 35 mm, острые
- 15-72-462-40 Valven** 40 mm, stumpf / blades 40 mm, blunt / valves 40 mm, mousse / Valvas 40 mm / сменные лопатки 40 mm, тупые  
**15-72-462-40Z Valven** 40 mm, scharf / blades 40 mm sharp / valves 40 mm, pointu / Valvas 40 mm / сменные лопатки 40 mm, острые
- 15-72-462-45 Valven** 45 mm, stumpf / blades 45 mm, blunt / valves 45 mm, mousse / Valvas 45 mm / сменные лопатки 45 mm, тупые  
**15-72-462-45Z Valven** 45 mm, scharf / blades 45 mm, sharp / valves 45 mm, pointu / Valvas 45 mm / сменные лопатки 45 mm, острые
- 15-72-462-50 Valven** 50 mm, stumpf / blades 50 mm, blunt / valves 50 mm, mousse / Valvas 50 mm / сменные лопатки 50 mm, тупые  
**15-72-462-50Z Valven** 50 mm, scharf / blades 50 mm, sharp / valves 50 mm, pointu / Valvas 50 mm / сменные лопатки 50 mm, острые
- 15-72-462-55 Valven** 55 mm, stumpf / blades 55 mm, blunt / valves 55 mm, mousse / Valvas 55 mm / сменные лопатки 55 mm, тупые  
**15-72-462-55Z Valven** 55 mm, scharf / blades 55 mm, sharp / valves 55 mm, pointu / Valvas 55 mm / сменные лопатки 55 mm, острые

**Bauchdeckenhalter**  
**Abdominal Retractors**  
**Ecarteurs abdominaux**  
**Separadores abdominales**  
**Расширители для брюшины**



**COLLIN-BABY**  
 18,0 cm, 7"  
 15-30-330-18



18 x 42 mm **15-30-330-23**  
 28 x 42 mm **15-30-330-30**

Wechselvalven  
 Exchangeable blades  
 Valves latéral  
 Valvas intergambiabiles  
 Сменные лопатки



60 x 80 mm **15-31-399-23**  
 72 x 85 mm **15-31-399-14**

55 x 70 mm **15-31-310-02**  
 80 x 90 mm **15-31-310-03**

28,0 cm, 11" **15-31-310-10**  
 30,0 cm, 12" **15-31-312-10**

Sperrer allein  
 Spreader only  
 Ecarteur  
 Separator profunes  
 Только рамка

280 mm **15-31-310-28 (15-31-310-10 / 15-31-310-02 / 15-31-399-23)**  
 300 mm **15-31-312-30 (15-31-312-10 / 15-31-310-03 / 15-31-399-14)**

**RICHARD**

besteht aus: Sperrer, 1 Paar Valven, 1 Mittelvalve  
 consisting of: Spreader, 1 Paar of Blades, 1 central Blade  
 consistant de: Ecarteur, 1 paire de valves, 1 valve centrale  
 compuesto de: Separator, 1 pareja de valvas, 1 valva centrale  
 состоит из: рамки, 1 пары сменных лопаток, 1 центрального шпателя



**COLLIN**

Central	COLLIN	Lateral
38 x 55 mm	<b>15-31-330-24</b>	60 x 38 mm
50 x 75 mm	<b>15-31-332-24</b>	80 x 38 mm

besteht aus: Sperrer, 1 Paar Valven, 1 Mittelvalve  
 consisting of: Spreader, 1 Paar of Blades, 1 central Blade  
 consistant de: Ecarteur, 1 paire de valves. 1 valve centrale  
 compuesto de: Separator, 1 pareja de valvas, 1 valva centrale  
 состоит из: рамки, 1 пары сменных лопаток, 1 центрального шпателя

38 x 62 mm  
**15-31-399-01**



**ROBIN-MASSE**  
**15-31-360-27**

**15-31-360-27 (15-31-399-01+15-31-360-01)**

besteht aus: Sperrer, 1 Paar Valven, 1 Mittelvalve  
 consisting of: Spreader, 1 Paar of Blades, 1 central Blade  
 consistant de: Ecarteur, 1 paire de valves. 1 valve centrale  
 compuesto de: Separator, 1 pareja de valvas, 1 valva centrale  
 состоит из: рамки, 1 пары сменных лопаток, 1 центрального шпателя

Bauchdeckenhalter  
Abdominal Retractors  
Ecarteurs abdominaux  
Separadores abdominales  
Расширители для брюшины

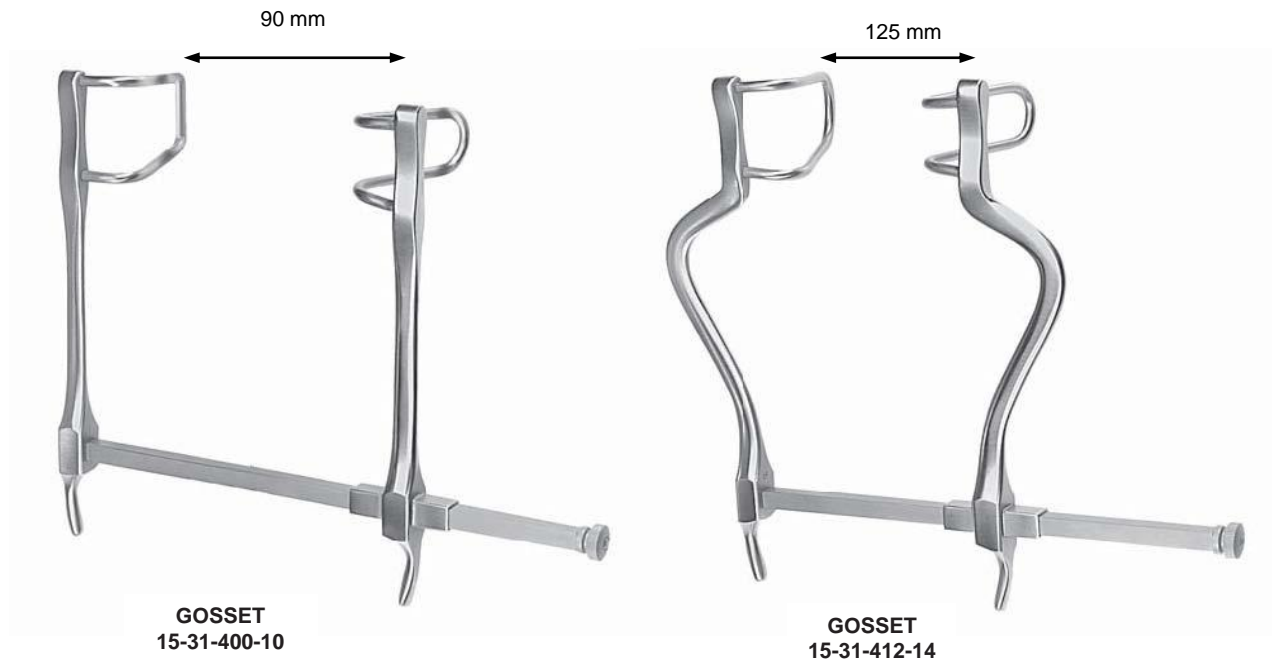



**BALFOUR**  
 15-31-764-18



**BALFOUR**  
 15-31-768-20

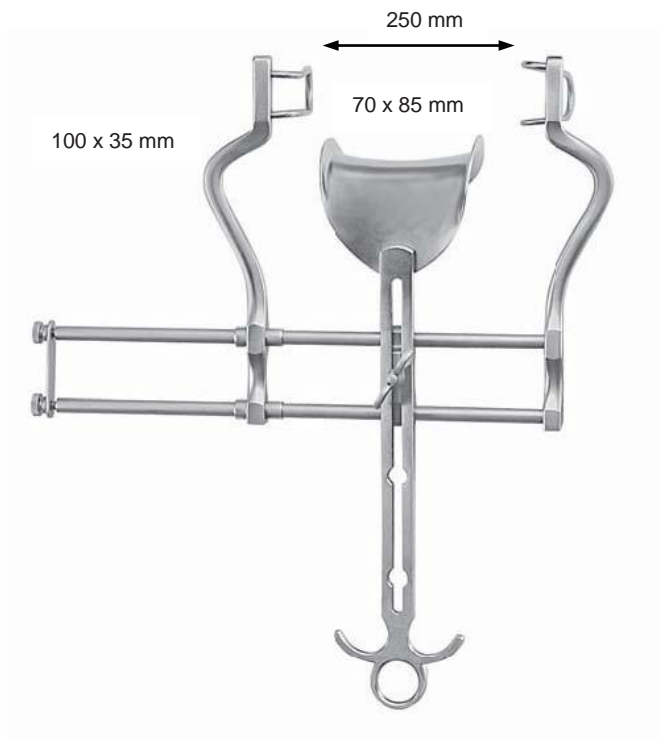

**BALFOUR**  
 15-31-768-25

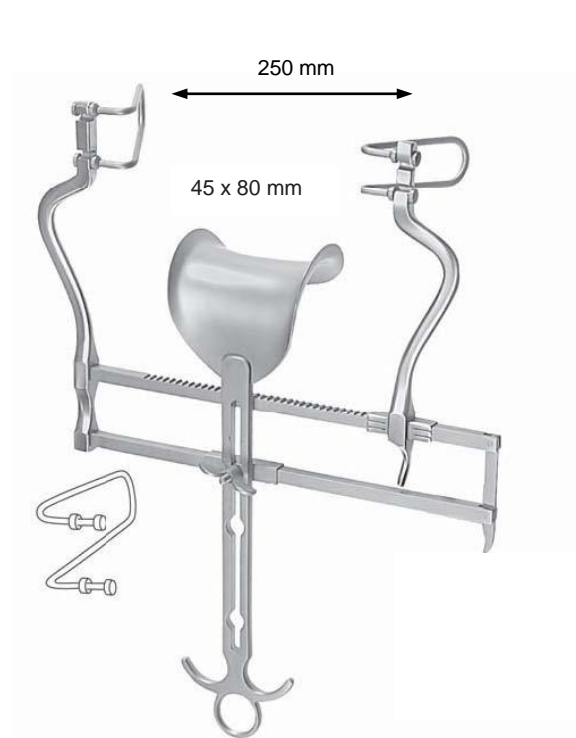

**BALFOUR US-TYPE**  
 15-31-772-25

Bauchdeckenhalter  
Abdominal Retractors  
Ecarteurs abdominaux  
Separadores abdominales  
Расширители для брюшины



- 40 x 60 mm **15-31-798-01**
- 45 x 80 mm **15-31-798-02**
- 68 x 85 mm **15-31-798-03**
- 70 x 85 mm **15-31-798-04**
- 80 x 90 mm **15-31-798-05**
- 100 x 70 mm **15-31-798-06**

**BALFOUR**

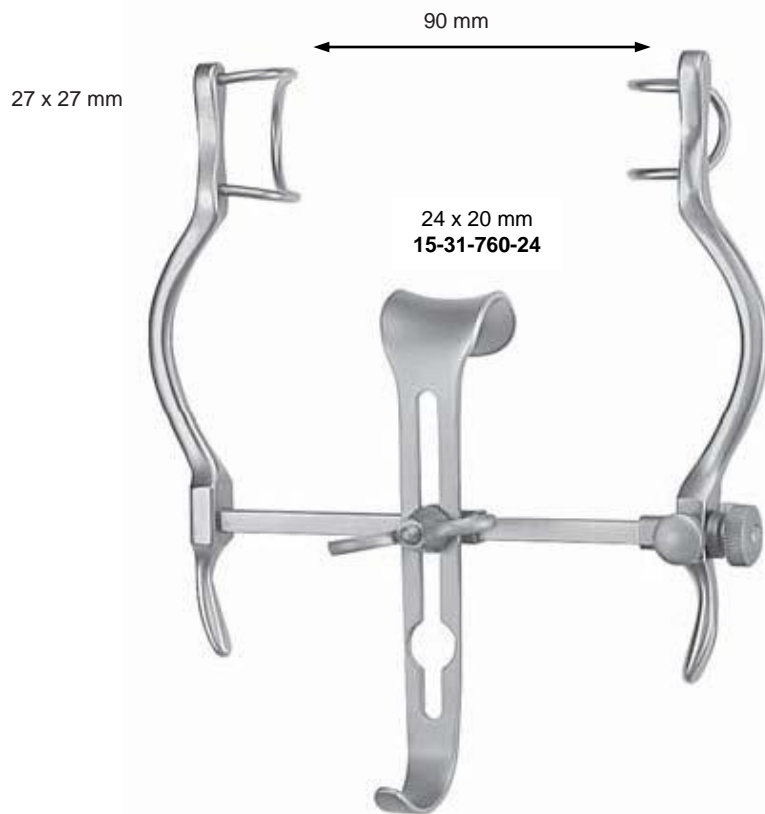

**BALFOUR**  
**15-31-760-09**

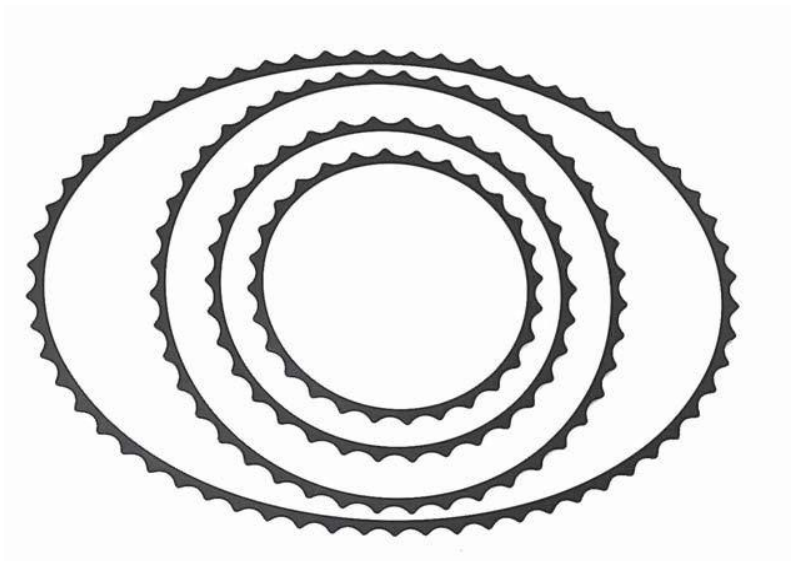

Ø 180 mm, 7"	15-31-850-18
Ø 230 mm, 9"	15-31-850-23
Ø 305 mm, 12"	15-31-850-30
455 x 330 mm	15-31-850-45

geschwärzt, black finish, noircie; negra, чёрное покрытие



15-31-859-01  
13 mm



15-31-859-02  
51 x 38 mm



15-31-859-03  
70 x 60 mm



15-31-859-04  
89 x 60 mm



15-31-859-05  
114 x 60 mm



**Bauchdeckenhalter  
Abdominal Retractors  
Ecarteurs abdominaux  
Separadores abdominales  
Расширители для брюшин**

**15-31-860-22**  
40 x 40 mm

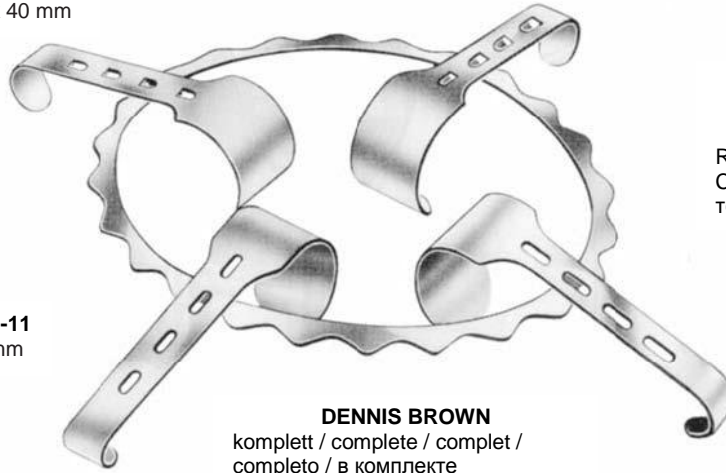

**15-31-860-11**  
40 x 30 mm

**15-31-860-01**  
255 x 180 mm

Rahmen allein / frame only /  
Cadre seul / cuadro suelto /  
только рамка

**DENNIS BROWN**

komplett / complete / complet /  
completo / в комплекте  
255 x 180 mm

**15-31-860-00** (1x **15-31-860-01**  
2x **15-31-860-22**  
2x **15-31-860-11**)

**15-31-870-01**

Rahmen allein  
Cadre seul  
frame only  
solo telaio  
только рамка



80 x 45 mm **15-31-870-11**  
45 x 80 mm **1531-870-13**

**O'SULLIVAN-O'CONNOR**

**15-31-870-00**

komplett  
complete  
complet  
completo  
в комплекте

**15-31-870-12**  
110 x 70 mm



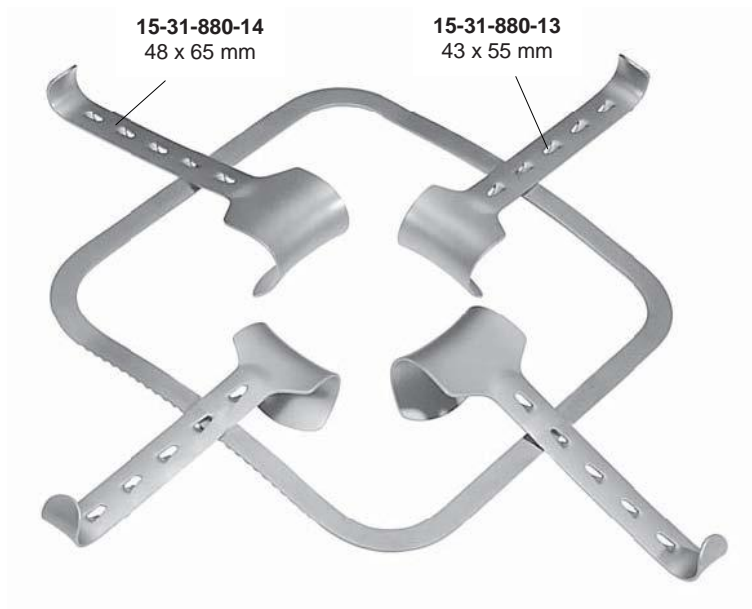

**15-31-880-01**  
240 x 240 mm

Rahmen allein / frame only /  
Cadre seul / cuadro suelto /  
только рамка

**KIRSCHNER**  
**15-31-880-00**

komplett / complete /  
complet / completo /  
в комплекте

1 x 15-31-880-01  
2 x 15-31-880-13  
2 x 15-31-880-14

**KIRSCHNER**  
**15-31-880-00**



**15-31-882-01**  
250 x 250 mm

zusammenlegbarer Rahmen, allein  
folding frame, only  
cadre pliant, seul  
cuadro piegable, suelto  
только складная рамка

**KIRSCHNER**  
**15-31-882-00**

komplett / complete /  
complet / completo /  
в комплекте

1 x 15-31-882-01  
2 x 15-31-880-13  
2 x 15-31-880-14



43 x 55 mm 15-31-880-13  
48 x 65 mm 15-31-880-14  
80 x 90 mm 15-31-880-15

**KIRSCHNER**

Bauchdeckenhalter  
Abdominal Retractors  
Ecarteurs abdominaux  
Separadores abdominales  
Расширители для брюшины



**KIRSCHNER**

98 x 51 mm **15-31-880-20**  
105 x 38 mm **15-31-880-21**

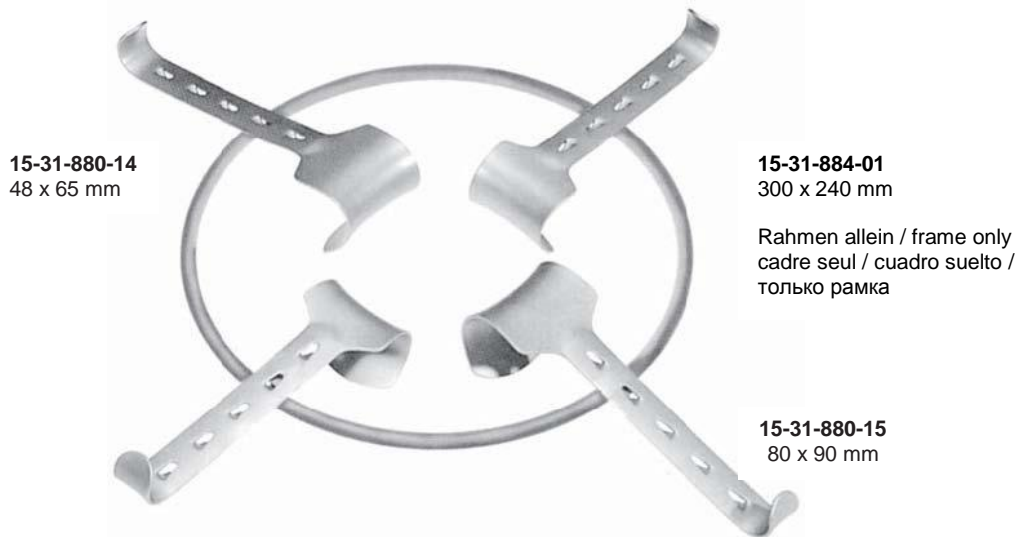

**15-31-880-14**  
48 x 65 mm

**15-31-884-01**  
300 x 240 mm

Rahmen allein / frame only  
cadre seul / cuadro suelto /  
только рамка

**15-31-880-15**  
80 x 90 mm

**KIRSCHNER, oval**  
**1531-884-00**

komplett, complete,  
complet, completo,  
в комплекте

1 x 15-31-884-01  
3 x 15-31-880-14  
1 x 15-31-880-15  
1 x 15-31-880-20  
1 x 15-31-880-21



Bauchdeckenhalter  
Abdominal Retractors  
Ecarteurs abdominaux  
Separadores abdominales  
Расширители для брюшины

15-31-890-13  
76 x 98 mm

15-31-870-12  
47 x 65 mm

47 x 65 mm

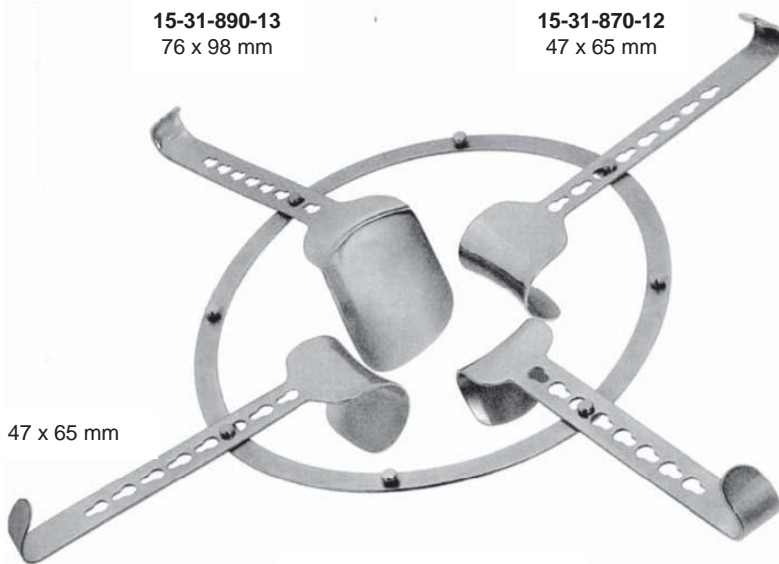

15-31-890-11  
98 x 52 mm

15-31-890-12  
105 x 35 mm

15-31-890-01  
275 x 250 mm

15-31-890-15  
50 x 54 mm

Rahmen allein / frame only /  
cadre seul / cuadro suelto /  
только рамка

15-31-900-13  
38 x 60 mm



15-31-900-01  
300 x 300 mm

zusammenlegbarer Rahmen, allein  
folding frame, only  
cadre pliant seul  
cuadro plegable, suelto  
только складная рамка

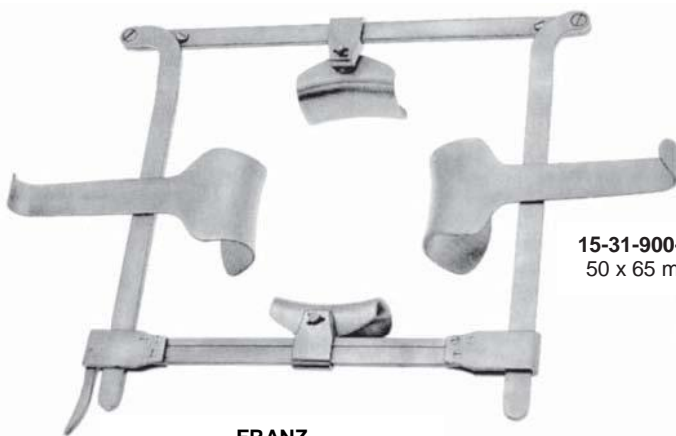

15-31-900-11  
50 x 65 mm

FRANZ  
15-31-900-00

komplett / complete / complet /  
completo / в комплекте

- 1 x 15-31-900-01
- 2 x 15-31-900-11
- 2 x 15-31-900-13



38 x 60 mm 15-31-900-13  
45 x 80 mm 15-31-900-14



50 x 65 mm 15-31-900-11  
60 x 85 mm 15-31-900-12

**Bauchdeckenhalter  
Abdominal Retractors  
Ecarteurs abdominaux  
Separadores abdominales  
Расширители для брюшины**

Befestigungsgestell  
Mounting frame  
Fixation châssis  
Bastidor para la fijación  
Рамка манипуляционная

53,0 cm, 21"



66,0 cm, 26"

**ROCHARD**  
15-31-920-01

53,0 cm, 21"



66,0 cm, 26"

**ROCHARD**  
15-31-920-02

Kette mit Gewicht  
Chain with weight  
Cadena con pesa  
Chaîne avec poids  
Цепочка с гирей



**15-31-915-30**  
78,5 cm, 31"



**DOYEN**  
28,0 cm, 11"

95 x 60 mm **15-31-910-11**  
105 x 65 mm **15-31-910-12**  
115 x 65 mm **15-31-910-13**  
125 x 65 mm **15-31-910-14**



**ROCHARD**  
28,0 cm, 11"  
**15-31-920-20**

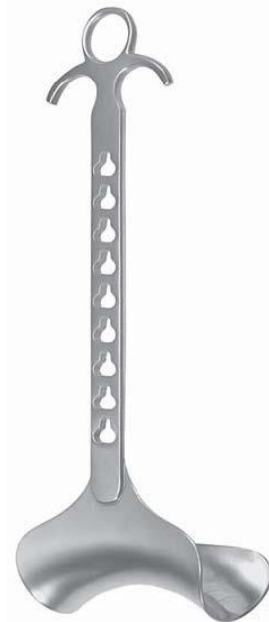

**ROCHARD**  
28,0 cm, 11"

95 x 48 mm **15-31-920-10**  
105 x 48 mm **15-31-920-11**  
115 x 48 mm **15-31-920-12**  
125 x 48 mm **15-31-920-13**  
155 x 48 mm **15-31-920-16**



Bauchspatel  
Abdominal Spatulas  
Espátulas abdominales  
Spatules abdominales  
Шпатели для брюшины



biegsam  
malleable  
malléable  
maleable  
изгибаемые

200 x 6 mm **15-32-210-06**  
200 x 12 mm **15-32-210-12**  
200 x 17 mm **15-32-210-17**  
200 x 20 mm **15-32-210-20**  
200 x 25 mm **15-32-210-25**

RIBBON



biegsam  
malleable  
malléable  
maleable  
изгибаемые

330 x 13 mm **15-32-170-13**  
330 x 19 mm **15-32-170-19**  
330 x 25 mm **15-32-170-25**  
330 x 30 mm **15-32-170-30**  
330 x 32 mm **15-32-170-32**  
330 x 40 mm **15-32-170-40**  
330 x 50 mm **15-32-170-50**  
330 x 75 mm **15-32-170-75**

RIBBON



biegsam  
malleable  
malléable  
maleable  
изгибаемые

280 x 25/30 mm **15-32-200-01**  
300 x 37/45 mm **15-32-200-02**  
300 x 40/50 mm **15-32-200-03**

HABERER



biegsam  
malleable  
malléable  
maleable  
изгибаемые

TUFFIER  
200 x 25/17 mm  
**15-32-220-20**



REVERDIN  
280 x 45/60 mm  
**15-32-230-28**

Rippensperrer  
 Rib Spreaders  
 Ecarteurs des cotes  
 Separadores costales  
 Рёберный расширитель



rostfrei  
 stainless steel  
 inoxydable  
 inox  
 нержавеющей сталь

**a** Tiefe / Depth / Profondeur / Profondite / глубина  
**b** Breite / Width / Ancho / Largeur / ширина  
**c** Spreizung / Spread / Abertura / Ecartement / расширение

a	b	c	
18 mm	20 mm	75 mm	<b>15-47-100-01</b>
12 mm	15 mm	70 mm	<b>15-47-100-06</b>

**FINOCCHIETTO-BABY/INFANT**

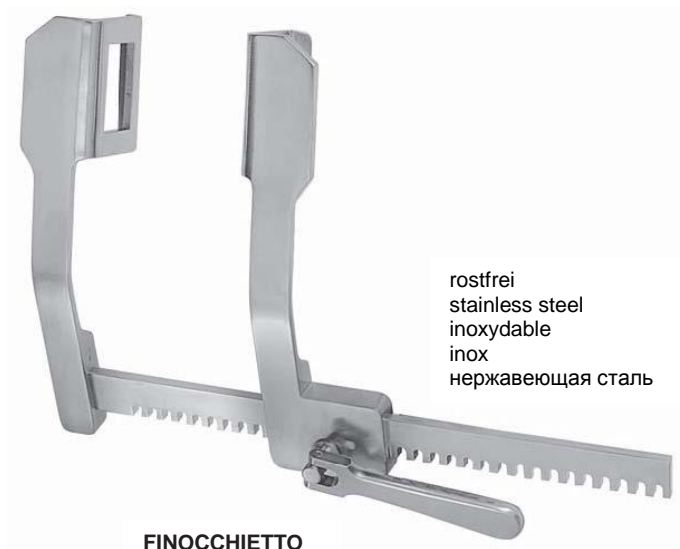

rostfrei  
 stainless steel  
 inoxydable  
 inox  
 нержавеющей сталь

a	b	c	
40 mm	40 mm	165 mm	<b>15-47-100-02</b>
45 mm	65 mm	200 mm	<b>15-47-100-03</b>
70 mm	65 mm	250 mm	<b>15-47-100-04</b>
70 mm	65 mm	300 mm	<b>15-47-100-05</b>

**FINOCCHIETTO**



rostfrei  
 stainless steel  
 inoxydable  
 inox  
 нержавеющей сталь

a	b	c	
50 mm	45 mm	165 mm	<b>15-47-150-01</b>

**TUFFIER**



- a** Tiefe / Depth / Profondeur / Profondite / глубина  
**b** Breite / Width / Ancho / Largeur / ширина  
**c** Spreizung / Spread / Aberture / Ecartement / расширение

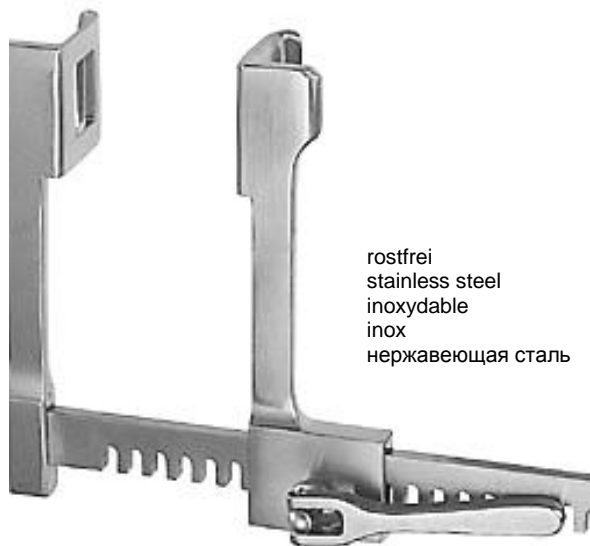

rostfrei  
stainless steel  
inoxydable  
inox  
нержавеющая сталь

a	b	c	
30 mm	30 mm	90 mm	15-47-110-00

HAIGGH



rostfrei  
stainless steel  
inoxydable  
inox  
нержавеющая сталь

a	b	c	
51 mm	44 mm	162 mm	15-72-450-00

BADGLEY

Wundspreizer  
Self-Retaining Retractors  
Ecarteurs autostatiques  
Separadores con retenida automática  
Самоудерживающиеся ранорасширители



**A** Tiefe / Depth / Profondeur / Profondite / глубина  
**B** Spreizung / Spread / Aberture / Ecartement / расширение

<b>A</b>	<b>B</b>	
50 mm	32 mm	<b>15-315-50-11</b>
38 mm	24 mm	<b>15-315-38-07</b>
32 mm	19 mm	<b>15-315-32-06</b>
25 mm	15 mm	<b>15-315-25-06</b>





Leicht  
Medizintechnik

**Sonden, Trokare, Hähne, Verbindungsstücke  
Probes, Trocars, Stopcocks, Connecting Pieces  
Sondes, Trocarts, Robinets, Raccords,  
Sondas, Trócares, Llaves, Piezas de conexión  
Зонды, троакары, запорные краны,  
соединительные детали**







Sonden  
Probes  
Sondes boutonées  
Sondas  
Зонды



Ø1,0 mm      Ø 2,0 mm

11,5 cm, 4½"	17-33-000-11	17-33-004-11
13,0 cm, 5"	17-33-000-13	17-33-004-13
14,5 cm, 5¾"	17-33-000-14	17-33-004-14
16,0 cm, 6¼"	17-33-000-16	17-33-004-16
18,0 cm, 7"	17-33-000-18	17-33-004-18
20,0 cm, 8"	17-33-000-20	17-33-004-20
25,0 cm, 10"	17-33-000-25	17-33-004-25



Ø 2,0 mm

11,5 cm, 4½"	17-33-013-11
13,0 cm, 5"	17-33-013-13
14,5 cm, 5¾"	17-33-013-14
16,0 cm, 6¼"	17-33-013-16
18,0 cm, 7"	17-33-013-18
20,0 cm, 8"	17-33-013-20
25,0 cm, 10"	17-33-013-25

Ø1,0 mm



Silber  
Silver  
Argent  
Plata  
Серебро

**STACKE**  
10,5 cm, 4⅞"  
17-33-033-10



Myrtenblattsonden  
Myrtle leaf probes  
Sonde feuille de myrte  
Sondas para mirto  
Зонд - лист мирта

10,5 cm, 4⅞"	17-33-027-11
13,0 cm, 5"	17-33-027-13
14,5 cm, 5¾"	17-33-027-14
16,0 cm, 6¼"	17-33-027-16
20,0 cm, 8"	17-33-027-20



**NÉLATON**  
16,0 cm, 6¼"  
17-33-120-16



**DOYEN**  
14,0 cm, 5¾"  
17-33-117-14



**BRODIE**  
20,0 cm, 8"  
17-33-126-20

Sonden  
Probes  
Sondes  
Sondas  
Зонды

Ø 3,5 mm

Ø 3,3 mm

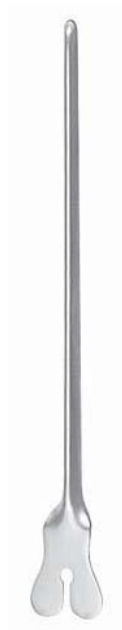

11,5 cm, 4½"	17-33-110-11
13,0 cm, 5"	17-33-110-13
14,5 cm, 5¾"	17-33-110-14
16,0 cm, 6¾"	17-33-110-16
18,0 cm, 7"	17-33-110-18
20,0 cm, 8"	17-33-110-20

13,0 cm, 5"	17-33-122-13
14,5 cm, 5¾"	17-33-122-14
16,0 cm, 6¾"	17-33-122-16
18,0 cm, 7"	17-33-122-18

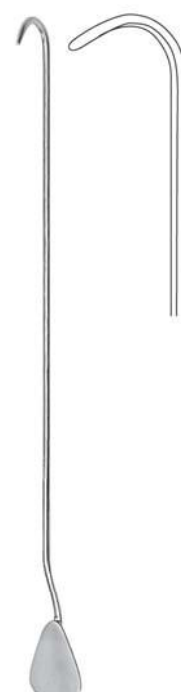
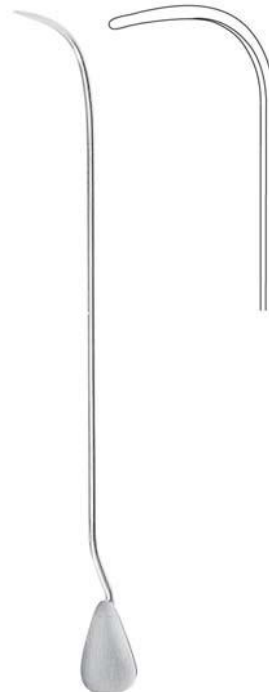

**LOCKHART-MUMMERY**  
16,5 cm, 6½"  
17-33-130-01

**LOCKHART-MUMMERY**  
16,5 cm, 6½"  
17-33-130-02

**LOCKHART-MUMMERY**  
16,5 cm, 6½"  
17-33-130-03

**LOCKHART-MUMMERY**  
16,5 cm, 6½"  
17-33-130-04



**FEIN**  
28,0 cm, 11"  
17-33-264-28



**UKERMANN**  
15,0 cm, 6"  
17-33-260-15



**JOBSON-HORNE**  
12,0 cm, 4<sup>3</sup>/<sub>4</sub>" 17-33-262-12  
18,0 cm, 7" 17-33-262-18



12,0 cm, 4<sup>3</sup>/<sub>4</sub>" 17-33-271-12 Ø 0,9 mm  
14,0 cm, 5<sup>3</sup>/<sub>4</sub>" 17-33-271-14 Ø 0,9 mm  
16,5 cm, 6<sup>1</sup>/<sub>4</sub>" 17-33-271-16 Ø 1,1 mm  
18,0 cm, 7" 17-33-271-18 Ø 1,2 mm

**FARRELL  
(LATHBURY)**



12,0 cm, 4<sup>3</sup>/<sub>4</sub>" 17-33-270-12 Ø 0,9 mm  
14,0 cm, 5<sup>3</sup>/<sub>4</sub>" 17-33-270-14 Ø 0,9 mm  
16,5 cm, 6<sup>1</sup>/<sub>4</sub>" 17-33-270-16 Ø 1,1 mm  
18,0 cm, 7" 17-33-270-18 Ø 1,2 mm  
23,0 cm, 9" 17-33-270-23 Ø 1,2 mm

**FARRELL**

**Krampfader-Besteck**  
**Varicose Vein Probe Set**  
**Astuccio per varici**  
**Juego para várices**  
**Набор зондов для варикозных вен**



**17-33-150-01**  
 135 x 100 x 25 mm

Metalletui  
 Metal case  
 Boite en Métal  
 Estuche de metal  
 Коробка металлическая



Ø 3,0 mm  
**17-33-150-03**



Ø 6,0 mm  
**17-33-150-06**



Ø 9,0 mm  
**17-33-150-09**



Ø 12,0 mm  
**17-33-150-12**

**NABATOFF**  
**17-33-150-00**

komplett / complete /  
 complet / completo /  
 комплект



**17-33-150-21**

Zugseil  
 Cable  
 Câble tracteur  
 Cable  
 Кабель

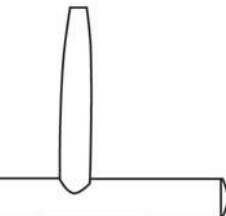

**17-33-150-20**

**17-33-150-22**

Kunststoff-Sondenspitze  
 Plastic probe tip  
 Pointe en Plastique  
 Extremidad de sonda de plástico  
 Пластмассовый наконечник зонда

Handgriff  
 Handle  
 Manche Tracteur  
 Mango  
 Ручка



- Ø 3,0 mm 17-34-110-30
- Ø 3,5 mm 17-34-110-35
- Ø 4,0 mm 17-34-110-40
- Ø 4,5 mm 17-34-110-45
- Ø 5,0 mm 17-34-110-50
- Ø 5,5 mm 17-34-110-55
- Ø 6,0 mm 17-34-110-60

**STANDARD**  
11,0 cm, 4<sup>3</sup>/<sub>8</sub>"



- Ø 3,0 mm 17-34-112-30
- Ø 3,5 mm 17-34-112-35
- Ø 4,0 mm 17-34-112-40
- Ø 4,5 mm 17-34-112-45
- Ø 5,0 mm 17-34-112-50
- Ø 5,5 mm 17-34-112-55
- Ø 6,0 mm 17-34-112-60

**STANDARD**  
12,0 cm, 4<sup>3</sup>/<sub>8</sub>"



- Ø 3,0 mm 17-34-114-30
- Ø 3,5 mm 17-34-114-35
- Ø 4,0 mm 17-34-114-40
- Ø 4,5 mm 17-34-114-45
- Ø 5,0 mm 17-34-114-50
- Ø 5,5 mm 17-34-114-55
- Ø 6,0 mm 17-34-114-60

**STANDARD**  
12,0 cm, 4<sup>3</sup>/<sub>8</sub>"



- Ø 7,3 mm 17-34-118-07
- Ø 8,7 mm 17-34-118-09
- Ø 12,0 mm 17-34-118-12

**HURWITZ**



- Ø 4,5 mm
- Ø 3,0 mm
- Ø 1,75 mm

**UNIVERSAL**  
17-34-100-03

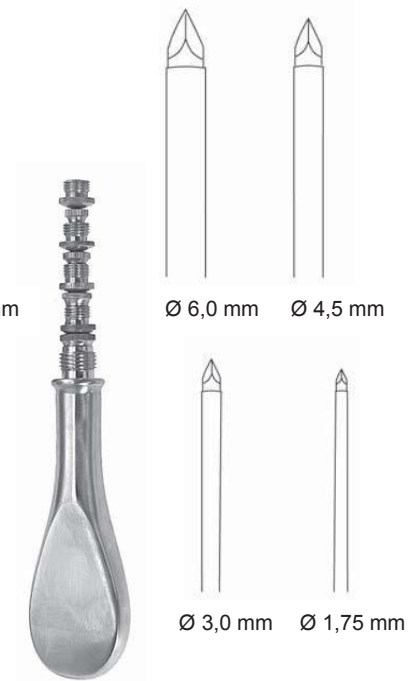

- Ø 6,0 mm
- Ø 4,5 mm

- Ø 3,0 mm
- Ø 1,75 mm

**UNIVERSAL**  
17-34-100-04

Trokare  
Trocars  
Trocarts  
Trócares  
Троакары

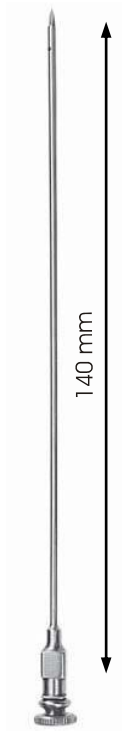

**LANDAU**  
Ø 2,0 mm  
17-34-160-16



**LANDAU**  
Ø 2,0 mm  
17-34-161-16



**DAVIDSON**  
Ø 6,0 mm  
17-34-164-18



**BUELAU**  
Ø 6,0 mm 17-34-124-23  
Ø 8,0 mm 17-34-124-24  
Ø 10,0 mm 17-34-124-25





**LERMOYEZ**

- Ø 2,0 mm **17-34-130-20**
- Ø 2,5 mm **17-34-130-25**
- Ø 3,0 mm **17-34-130-30**



**CAMPBELL**  
16,0 cm, 6¼"

- Ø 6,0 mm **17-34-128-06**
- Ø 8,0 mm **17-34-128-08**



**NELSON**  
21,0 cm, 8½"

- Ø 7,5 mm **17-34-120-01**
- Ø 9,0 mm **17-34-120-02**
- Ø 11,0 mm **17-34-120-03**
- Ø 12,5 mm **17-34-120-04**

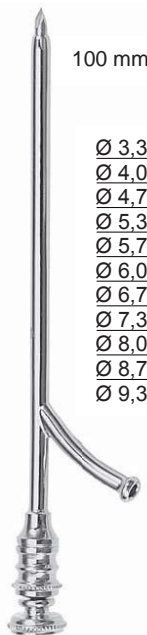

**OCHSNER**  
14,0 cm, 5½"

100 mm

- Ø 3,3 mm **17-34-140-01**
- Ø 4,0 mm **17-34-140-02**
- Ø 4,7 mm **17-34-140-03**
- Ø 5,3 mm **17-34-140-04**
- Ø 5,7 mm **17-34-140-05**
- Ø 6,0 mm **17-34-140-06**
- Ø 6,7 mm **17-34-140-07**
- Ø 7,3 mm **17-34-140-08**
- Ø 8,0 mm **17-34-140-09**
- Ø 8,7 mm **17-34-140-10**
- Ø 9,3 mm **17-34-140-11**



**PIERCE**  
16,0 cm, 6¼"

- Ø 3,0 mm **17-34-180-30**
- Ø 4,0 mm **17-34-180-40**
- Ø 5,0 mm **17-34-180-50**



**COAKLEY**  
14,0 cm, 5¼"  
**17-34-190-14**

Ø 2,5 mm

Trokare, Saugrohre  
 Trocars, Suction Tubes  
 Trocars, Tubes d'aspiration  
 Trócares, Tubos para aspiración  
 Троакары, отсасывающие трубки



**KRAUSE**  
 16,0 cm, 6¼"

**LICHTWITZ**  
 Kieferhöhlentrokare  
 Antrum trocars  
 maxillaire troglodytique Trocars  
 Trócares para el seno maxilar  
 Троакар для полостей

- Ø 3,0 mm **17-34-184-30**
- Ø 4,0 mm **17-34-184-40**
- Ø 5,0 mm **17-34-184-50**
- Ø 5,5 mm **17-34-184-55**

Ø 1,8 mm



**LICHTWITZ**  
 20,0 cm, 8"  
**17-34-170-00**

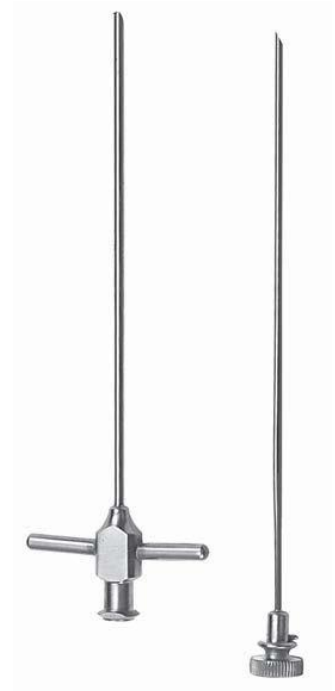

**LICHTWITZ**  
 11,0 cm 4¼"  
 Ø 1,6 cm **17-34-172-16**  
 Ø 1,8 cm **17-34-172-18**



**DOUGLAS**  
 Ø 3,0 mm  
**17-34-175-00**



**POOLE**  
 L 190 mm Ø 5,5 mm **17-35-020-06**  
 L 245 mm Ø 8,0 mm **17-35-020-08**  
 L 235 mm Ø 10,0 mm **17-35-020-10**



**POOLE**  
 L 190 mm Ø 6,0 mm **17-35-021-06**  
 L 245 mm Ø 8,0 mm **17-35-021-08**  
 L 235 mm Ø 10,0 mm **17-35-021-10**



auswechselbare Spitze  
interchangeable tip  
Pointe de succion  
Punta intercambiabiles  
Сменный наконечник



- Ø 1,5 mm 17-35-010-15
- Ø 1,9 mm 17-35-010-19
- Ø 2,3 mm 17-35-010-23
- Ø 2,8 mm 17-35-010-28

**COUPLAND**  
16,5cm, 6¼"  
17-35-010-17



17-35-000-00



Olive allein  
Olive only  
Olive seul  
Oliva suelto  
только олива

- Ø 1,8 mm 17-35-000-18
- Ø 2,0 mm 17-35-000-20
- Ø 4,8 mm 17-35-000-48

**YANKAUER**



**DE BAKKEY**  
27,0 cm, 10¾"  
17-35-008-27



**ANTHONY**  
26,0 cm, 10¼"  
17-35-007-26



Ø 2,3 mm

- Ø 3,0 mm 17-35-006-30
- Ø 4,0 mm 17-35-006-40
- Ø 6,0 mm 17-35-006-60

**ANDREWS-PYNCHON**  
24,0 cm, 9½"



**COGSWELL**  
23,0 cm, 9"  
17-35-014-23



- Charr. 10 17-35-050-10
- Charr. 11 17-35-050-11
- Charr. 12 17-35-050-12
- Charr. 14 17-35-050-14
- Charr. 15 17-35-050-15

**ADSON**  
21,0 cm, 8¼"

Saugrohre  
Suction Tubes  
Tubes d'aspiration  
Tubos para aspiración  
Отсасывающие трубки



**COOLEY**  
33,0 cm, 13", Ø 8,0 mm  
17-35-024-01



**COOLEY**  
35,0 cm, 13¾", Ø 8,0 mm  
17-35-024-02



**COOLEY**  
30,0 cm, 11¾", Ø 7,0 mm  
17-35-024-03



**COOLEY**  
31,0 cm, 12¾", Ø 10,0 mm  
17-35-024-04



Ø 1,5 mm 17-35-012-15  
Ø 2,5 mm 17-35-012-25  
Ø 3,5 mm 17-35-012-35

**BYRD**  
15,0 cm, 8"



**HEPP/SCHIEDL**  
22,5 cm, 8¾"  
17-35-016-22



Ø 1,0 mm 17-35-060-01  
Ø 2,0 mm 17-35-060-02  
Ø 3,0 mm 17-35-060-03  
Ø 3,5 mm 17-35-060-35  
Ø 4,0 mm 17-35-060-04

**MAGILL**  
17,5 cm, 6⅝"  
17-35-060-05

45° L=100 mm

45° L=130 mm

45° L=180 mm

- Charr. 3 17-35-030-03
- Charr. 4 17-35-030-04
- Charr. 5 17-35-030-05
- Charr. 6 17-35-030-06
- Charr. 7 17-35-030-07
- Charr. 8 17-35-030-08
- Charr. 9 17-35-030-09
- Charr. 10 17-35-030-10
- Charr. 11 17-35-030-11
- Charr. 12 17-35-030-12
- Charr. 14 17-35-030-14
- Charr. 15 17-35-030-15

- Charr. 3 17-35-031-03
- Charr. 4 17-35-031-04
- Charr. 5 17-35-031-05
- Charr. 6 17-35-031-06
- Charr. 7 17-35-031-07
- Charr. 8 17-35-031-08
- Charr. 9 17-35-031-09
- Charr. 10 17-35-031-10
- Charr. 11 17-35-031-11
- Charr. 12 17-35-031-12
- Charr. 14 17-35-031-14
- Charr. 15 17-35-031-15

- Charr. 3 17-35-032-03
- Charr. 4 17-35-032-04
- Charr. 5 17-35-032-05
- Charr. 6 17-35-032-06
- Charr. 7 17-35-032-07
- Charr. 8 17-35-032-08
- Charr. 9 17-35-032-09
- Charr. 10 17-35-032-10
- Charr. 11 17-35-032-11
- Charr. 12 17-35-032-12
- Charr. 14 17-35-032-14
- Charr. 15 17-35-032-15



**FRAZIER**  
19,0 cm, 7½"

30°

75°

- Charr. 6 17-35-030-06.30
- Charr. 7 17-35-030-07.30
- Charr. 8 17-35-030-08.30
- Charr. 9 17-35-030-09.30
- Charr. 10 17-35-030-10.30
- Charr. 11 17-35-030-11.30
- Charr. 12 17-35-030-12.30
- Charr. 14 17-35-030-14.30
- Charr. 15 17-35-030-15.30

- Charr. 6 17-35-030-06.75
- Charr. 7 17-35-030-07.75
- Charr. 8 17-35-030-08.75
- Charr. 9 17-35-030-09.75
- Charr. 10 17-35-030-10.75
- Charr. 11 17-35-030-11.75
- Charr. 12 17-35-030-12.75
- Charr. 14 17-35-030-14.75
- Charr. 15 17-35-030-15.75



**FERGUSSON**  
11,0 cm, 7"



**POPPE**  
11,0 cm, 5"

- Charr. 3 17-35-033-03
- Charr. 4 17-35-033-04
- Charr. 5 17-35-033-05
- Charr. 6 17-35-033-06
- Charr. 7 17-35-033-07
- Charr. 8 17-35-033-08
- Charr. 9 17-35-033-09
- Charr. 10 17-35-033-10
- Charr. 11 17-35-033-11
- Charr. 12 17-35-033-12
- Charr. 14 17-35-033-14
- Charr. 15 17-35-033-15

- Charr. 3 17-35-034-03
- Charr. 4 17-35-034-04
- Charr. 5 17-35-034-05
- Charr. 6 17-35-034-06
- Charr. 7 17-35-034-07
- Charr. 8 17-35-034-08
- Charr. 9 17-35-034-09
- Charr. 10 17-35-034-10
- Charr. 11 17-35-034-11
- Charr. 12 17-35-034-12
- Charr. 14 17-35-034-14
- Charr. 15 17-35-034-15

Spezialkanülen, Saugrohre  
 Special Needles, Suction Tubes  
 Aiguilles spéciales, Tubes d'aspiration  
 Agujas especiales, Tubos para aspiración  
 Специальные иглы, отсасывающие трубки



Packung zu 12 Stück  
 Package of 12 pcs.  
 Raccord unité a 12 pièces  
 Cajecita de 12 pzs.  
 Упаковка из 12 шт.

- Ø 0,90 x 38 mm **17-36-000-01**
- Ø 0,80 x 32 mm **17-36-000-02**
- Ø 0,70 x 32 mm **17-36-000-03**
- Ø 0,65 x 28 mm **17-36-000-04**
- Ø 0,60 x 25 mm **17-36-000-05**
- Ø 0,50 x 23 mm **17-36-000-06**
- Ø 0,45 x 20 mm **17-36-000-07**

**LUER-LOCK**

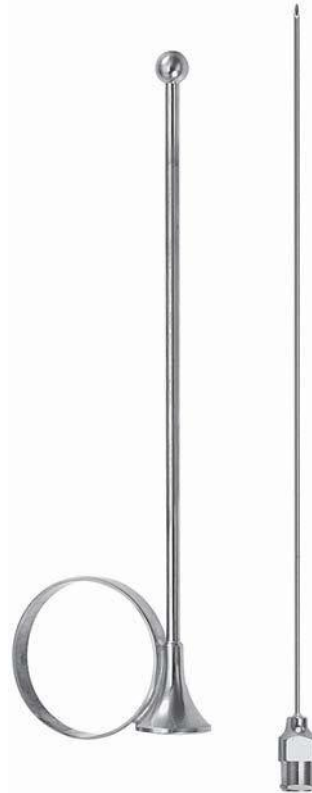

**17-36-150-01**

Nadel  
 Needle  
 Canule  
 Aguja  
 Игла

**IOWA**  
 14,0 cm, 5 1/4"  
**17-36-150-14**



**MOCK**  
 6,0 cm, 3/4"  
**17-36-200-06**



Kanülen zur Sternalpunktion  
 Sternum puncture needles  
 Aiguille pour ponction sternal  
 Agujas para la punción del esternón  
 Иглы для грудной пункции

Ø mm	L			Ø mm	L			
1,80	25	35	50	15 G	1"	1 1/2"	2"	<b>17-36-060-16</b>
2,00	25	35	70	14 G	1"	1 1/2"	2 3/4"	<b>17-36-060-18</b>
2,50	25	35	70	13 G	1"	1 1/2"	2 3/4"	<b>17-36-060-20</b>
2,80	25	35	80	12 G	1"	1 1/2"	3 1/4"	<b>17-36-060-22</b>
3,00	25	35		11 G	1"	1 1/2"		<b>17-36-060-24</b>

**KLIMA-ROSSEGGER - MARK LUER-LOCK**



Spezialkanülen, Saugrohre  
 Special Needles, Suction Tubes  
 Aiguilles spéciales, Tubes d'aspiration  
 Aguja especiales, Tubos para aspiración  
 Специальные иглы, отсасывающие трубки



Ø 1,20 x 80 mm 17-36-210-12  
 Ø 1,50 x 80 mm 17-36-210-15



Ø 2,1 x 80 mm 17-36-180-08  
 Ø 2,1 x 100 mm 17-36-180-10  
 Ø 2,1 x 120 mm 17-36-180-12  
 Ø 2,1 x 150 mm 17-36-180-15  
 Ø 2,1 x 170 mm 17-36-180-17  
 Ø 2,1 x 200 mm 17-36-180-20

VERESS



RÖNTGEN RADIOGRAPHIE

RÖNTGENOGRAPHY / Röntgen / рентген

Arteriographie und perkutane Gefäßkaterisierung

Arteriography and percutaneousvascular catheterisation

Рентген и радиография

SELDINGER-STILLE LUER-LOCK (A+B)

P 1

Ø mm	L mm	Ø mm	L	
1,40	70	18 G	2¾"	17-36-650-14
1,40	100	18 G	4"	17-36-051-14

SELDINGER Double LUER-LOCK (A+B+C)

P 2

Ø mm	L mm	Ø mm	L	
1,40	70	18 G	2¾"	17-36-652-14
1,40	100	18 G	4"	17-36-053-14

SELDINGER- LUER-LOCK (A+B)

P 3

Ø mm	L mm	Ø mm	L	
2,00	70	14 G	2¾"	17-36-650-20
2,00	100	14 G	4"	17-36-051-20

SELDINGER Double LUER-LOCK (A+B+C)

P 4

Ø mm	L mm	Ø mm	L	
2,00	70	14 G	2¾"	17-36-652-20
2,00	100	14 G	4"	17-36-053-20

ARTERIOGRAPHY LUER-LOCK (A+B+C+D)

Ø mm	L mm	Ø mm	L	
1,10	70	19 G	2¾"	17-36-654-11
1,10	100	19 G	4"	17-36-055-11
1,40	70	P 1	18 G	2¾"
1,40	100	P 1	18 G	4"
1,65	70	16 G	2¾"	17-36-654-16
1,65	100	16 G	4"	17-36-055-16
2,00	70	P 4	14 G	2¾"
2,00	100	P 4	14 G	4"

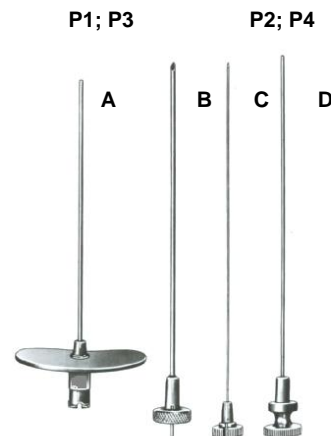

SELDINGER

Spezialkanülen  
Special Needles  
Aiguilles spéciales  
Agujas especiales  
Специальные иглы



Kanülen zur Lumbalpunktion  
Lumbar puncture needles  
Aiguille pour ponction lombare  
Agujas para punción lumbar  
Иглы для поясничной пункции

Ø mm	L mm					Ø mm	L					
0,80	70	80	90	100	120	21 G	2¾"	3¼"	3½"	4"	4¾"	17-36-130-01
1,00	70	80	90	100	120	19 G	2¾"	3¼"	3½"	4"	4¾"	17-36-130-02
1,20	70	80	90	100	120	18 G	2¾"	3¼"	3½"	4"	4¾"	17-36-130-03
1,40	70	80	90	100	120	17 G	2¾"	3¼"	3½"	4"	4¾"	17-36-130-04
1,60	70	80	90	100	120	16 G	2¾"	3¼"	3½"	4"	4¾"	17-36-130-05
1,80	70	80	90	100	120	15 G	2¾"	3¼"	3½"	4"	4¾"	17-36-130-06
2,00	70	80	90	100	120	14 G	2¾"	3¼"	3½"	4"	4¾"	17-36-130-07

BARKER BIER LUER-LOCK



SCHMID  
15,0 cm, 6"



Ø 3,0 mm  
17-36-140-03



Ø 2,0 mm  
17-36-140-02



Ø 4,0 mm  
17-36-140-04



Ø 5,0 mm  
17-36-140-05



Ø 6,0 mm  
17-36-140-06

Gefäßspülkanülen, biegsam  
Vascular irrigation cannulae, malleable  
Malléable raccord Luer-Lock argent, malléable  
Cánulas vasculares para irrigación, maleables  
Сосудистая ирригационная канюля, изгибаемая





Kanülen zur Lumbalpunktion  
Lumbar puncture needles  
Aiguille pour ponction lombare  
Agujas para punción lumbar  
Иглы для поясничной пункции



Ø 1,20 x 76 mm **17-36-120-01**  
Ø 1,20 x 89 mm **17-36-120-02**  
Ø 1,00 x 76 mm **17-36-120-03**  
Ø 1,00 x 89 mm **17-36-120-04**  
Ø 0,70 x 76 mm **17-36-120-05**  
Ø 0,70 x 50 mm **17-36-120-06**  
Ø 0,70 x 89 mm **17-36-120-07**

QUINKE

Kanülen zur Leberblindpunktion  
Liver blind puncture needles  
Aiguille pour ponction aveugle du foie  
Agujas para punción ciega del hígado  
Иглы для пункции печени

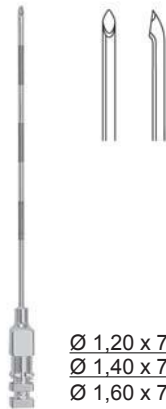

Ø 1,20 x 76 mm **17-36-090-12**  
Ø 1,40 x 76 mm **17-36-090-14**  
Ø 1,60 x 76 mm **17-36-090-16**

TUOHY



Ø 1,00 x 35 mm **17-36-115-01**  
Ø 1,00 x 70 mm **17-36-115-02**  
Ø 1,20 x 70 mm **17-36-115-03**  
Ø 1,20 x 100 mm **17-36-115-04**  
Ø 1,40 x 70 mm **17-36-115-05**  
Ø 1,40 x 100 mm **17-36-115-06**  
Ø 1,60 x 70 mm **17-36-115-07**  
Ø 1,60 x 100 mm **17-36-115-08**

MENGHINI

Kanülen zur gezielten Leberpunktion  
Needles for controlled liver puncture  
Agujas para la punción del hígado bajo el  
Aiguille pour ponction contrôlée du foie  
Control laparoscópio  
Иглы для пункции печени под контролем



Ø 1,40 x 168 mm **17-36-117-14**  
Ø 1,80 x 168 mm **17-36-117-18**

MENGHINI

Trokare für Kanülen  
Trocars for needles  
Trocarts pour aiguille  
Trocares para agujas  
Троакары для игл



Ø 1,40 x 168 mm **17-36-230-14**  
Ø 1,80 x 168 mm **17-36-230-18**

**Verbindungsstücke  
Connecting Pieces  
Raccords  
Piezas de conexión  
Соединительные детали**



**17-37-911-00**

Verbindungsstück, LUER-LOCK weiblich, LUER-LOCK männlich  
Adapter female-LUER LOCK / male LUER-LOCK  
Raccords, LUER LOCK femelle / LUER-LOCK male  
Соединительная деталь, замок Луер мама; замок Луер папа



**17-37-912-00**

Verbindungsstück, LUER-LOCK männlich / weiblich RECORD  
Adapter male -LUER / female RECORD  
Raccords, RECORD femelle/ LUER LOCK male  
Соединительная деталь, замок Луер папа, замок RECORD  
мама



**17-37-910-00**

Verbindungsstück, LUER-LOCK weiblich/RECORD männlich  
Adapter female-LUER LOCK / male RECORD  
Raccords, RECORD femelle / LUER LOCK male  
Соединительная деталь, замок Луер мама; RECORD папа



**17-37-913-00**

Verbindungsstück, 2 x LUER-LOCK, weiblich  
Adapter 2 x female-LUER LOCK  
Raccords, 2 x LUER LOCK femelle  
Соединительная деталь, 2 x замок Луер мама



**17-37-914-00**

Verbindungsstück, 2 x LUER-LOCK weiblich, mit Gewinde  
Adapter 2 x female-LUER LOCK, with thread  
Raccords, 2 x LUER LOCK femelle avec filet intérieur  
Соединительная деталь, 2 x замок Луер мама, с резьбой



**17-37-915-00**

Verbindungsstück, 2 x LUER-LOCK männlich  
Adapter 2 x male -LUER LOCK  
Raccords 2 x LUER LOCK male  
Соединительная деталь, 2 x замок Луер папа



**17-37-916-00**

Verbindungsstück 2x LUER männlich  
Adapter 2x male LUER  
Raccords 2 x LUER male  
Соединительная деталь, 2 x замок Луер папа



**17-37-917-00**

Verbindungsstück LUER LOCK männlich / LUER LOCK weiblich  
Adapter male LUER LOCK / female LUER LOCK  
Raccords, LUER LOCK femelle / LUER LOCK male  
Соединительная деталь, замок Луер папа, замок Луер мама



Ø 4,00 **17-37-918-04**

Ø 5,00 **17-37-918-05**

Ø 6,00 **17-37-918-06**

Ø 7,00 **17-37-918-07**

Ø 8,00 **17-37-918-08**

Ø 10,0 **17-37-918-10**

Schlauchverbinder LUER LOCK männlich  
Tube connector male LUER LOCK  
Raccords, LUER LOCK male  
Соединительная деталь замок Луер папа



Ø 4,00 **17-37-919-04**

Ø 5,00 **17-37-919-05**

Ø 6,00 **17-37-919-06**

Ø 7,00 **17-37-919-07**

Ø 8,00 **17-37-919-08**

Ø 10,0 **17-37-919-10**

Verbindungsstück LUER LOCK weiblich  
Tube connector female LUER LOCK  
Raccords LUER LOCK femelle  
Соединительная деталь, замок Луер мама

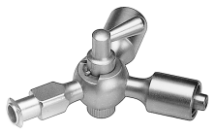

**17-37-920-00**

Dreiwegehahn LUER LOCK weiblich / 2 x LUER LOCK männlich  
Three-way stopcock female LUER LOCK / 2 x male LUER LOCK  
Robinet a trois voies 1 x femelle, 2 x male / Llave de 3 vias 1 x hembra 2 x macho / Запорный кран с тремя выходами, 1 x замок Луер мама, 2 x замка папа



**17-37-922-00**

Dreiwegehahn 2 x LUER LOCK weiblich / LUER LOCK männlich  
Three-way stopcock 2 x female LUER LOCK / male LUER LOCK  
Robinet a trois voies 2 x femelle, 1 x male / Llave de 3 vias 2 x hembra 1 x macho / Запорный кран с тремя выходами, 2 x замка Луер мама, 1 x замок папа



**17-37-926-00**

Federschraubkappe  
Spring screw cap  
Ressort bouchon filete.  
Пружинная закручиваемая головка



**17-37-930-01**

Durchflusshahn LUER LOCK männlich / LUER LOCK weiblich  
One-way stopcock male LUER LOCK / female LUER LOCK  
Robinet femelle / male / Llave 1 x hembra, 1 x macho /  
Запорный кран, 1 x замок Луер мама / 1 x замок Луер папа



**17-37-930-02**

Durchflusshahn LUER männlich / LUER LOCK weiblich  
One-way stopcock male LUER / female LUER LOCK  
Robinet femelle / male Llave 1 x hembra, 1x macho /  
Запорный кран, 1 x замок Луер папа / 1x замок Луер мама



**17-37-930-03**

Durchflusshahn LUER männlich / LUER LOCK weiblich, mit Gewinde  
One-way stopcock male LUER LOCK / female LUER LOCK, with thread  
Robinet femelle / male Llave 1 x hembra, 1 x macho /  
Запорный кран, 1 x замок Луер мама с резьбой 1 x замок Луер папа



**17-37-935-00**

Durchflusshahn LUER männlich / LUER LOCK weiblich  
One-way stopcock male LUER / female LUER LOCK  
Robinet femelle / male/ Llave 1 x hembra, 1 x macho /  
Запорный кран, 1 x замок Луер папа / 1 x замок Луер мама



**17-37-939-00**

Durchflusshahn LUER männlich / LUER LOCK weiblich, mit Gewinde  
One-way stopcock male LUER LOCK / female LUER LOCK, with thread  
Robinet femelle / male / Llave hembra / macho /  
Запорный кран, замок Луер мама с резьбой / замок Луер папа



**17-37-940-00**

Dreiwegehahn LUER LOCK 2 x weiblich / 1 x LUER LOCK männlich  
Three-way stopcock 2x female LUER LOCK / 1 x male LUER LOCK  
Robinet a trois voies 2 x femelle, 1 x male / Llave de 3 vias 2 x hembra 1 x macho / Запорный кран с тремя выходами, 2 x замок Луер мама, 1 x замка папа



**17-37-941-00**

Durchflusshahn LUER weiblich / LUER LOCK weiblich,  
One-way stopcock female LUER LOCK / female LUER LOCK,  
Robinet femelle / femelle / Llave hembra / hembra /  
Запорный кран, замок Луер мама с резьбой / замок Луер папа

**Saug- und Spülinstrumente**  
**Suction and irrigation instruments**  
**Instrument d'aspiration et laver**  
**Instrument para aspiración, lavar**  
**Инструменты для отсасывания и промывания**



**17-37-942-00**

Saug- und Spülgriff, mit doppeltem Trompetenventil, Schlauchansatz Ø 7 u. 12 mm  
 Suction and irrigation handle, with double trumpet valve, hose end Ø 7 a. 12 mm  
 Poignée d'aspiration, laver, tubes Ø 7 u. 12 mm  
 Manipolador aspirante, lavar, tubos Ø 7 u. 12 mm  
 Ручка для отсасывания и промывания, с двойным трюмбетным клапаном, для трубок Ø 7 и 12 мм



**17-37-943-00**

Saug- und Spülgriff  
 Suction and irrigation handle  
 Poignée d'aspiration, laver  
 Manipolador aspirante, lavar  
 Ручка для отсасывания и промывания



**17-37-944-00**

Ø 5 x 330 mm  
 Saug- und Spülrohr  
 Suction and irrigation tube  
 Tubes d'aspiration, laver  
 Tubos para aspiración, lavar  
 Трубки для отсасывания и промывания



**17-37-945-00**

Ø 10 x 330 mm  
 Saug- und Spülrohr  
 Suction and irrigation tube  
 Tubes d'aspiration, laver  
 Tubos para aspiración, lavar  
 Трубки для отсасывания и промывания



**17-37-946-00**

Ø 5 x 450 mm  
 Saug- und Spülrohr, mit 2x Hähnen  
 Suction and irrigation tube, w. 2x stopcocks  
 Tubes d'aspiration, laver, 2x Robinets  
 Tubos para aspiración, lavar 2x Llaves  
 Трубки для отсасывания и промывания с 2-я кранами



**17-37-947-00**

Ø 5 x 330 mm  
 Saug- und Spülrohr, mit 2x Trompetenventil  
 Suction and irrigation tube, w. 2x trumpet valve  
 Tubes d'aspiration, laver 2x valva  
 Tubos para aspiración, lavar, 2x valva  
 Трубки для отсасывания и промывания с 2-я трюмбетными клапанами



Leicht  
Medizintechnik

**Galle, Leber, Niere, Blase, Urologie**  
**Gall, Liver, Kidney, Bladder, Urology**  
**Vésicule biliaire, Foie, Rion, Bulle, Urologie**  
**Bilis, Hígado, Riñon, Vejiga, Urología**  
**Желчный пузырь, печень, почки,**  
**Мочевой пузырь, урология**





Nierensteinzangen, Gallensteinzangen  
 Kidney Stone Forceps, Gall Stone Forceps  
 Pincès pour calculs rénaux, Pincès pour calculs biliaires  
 Pinzas para cálculos renales, Pinzas para cálculos biliares  
 Зажимы для почечных камней, зажимы для желчных камней

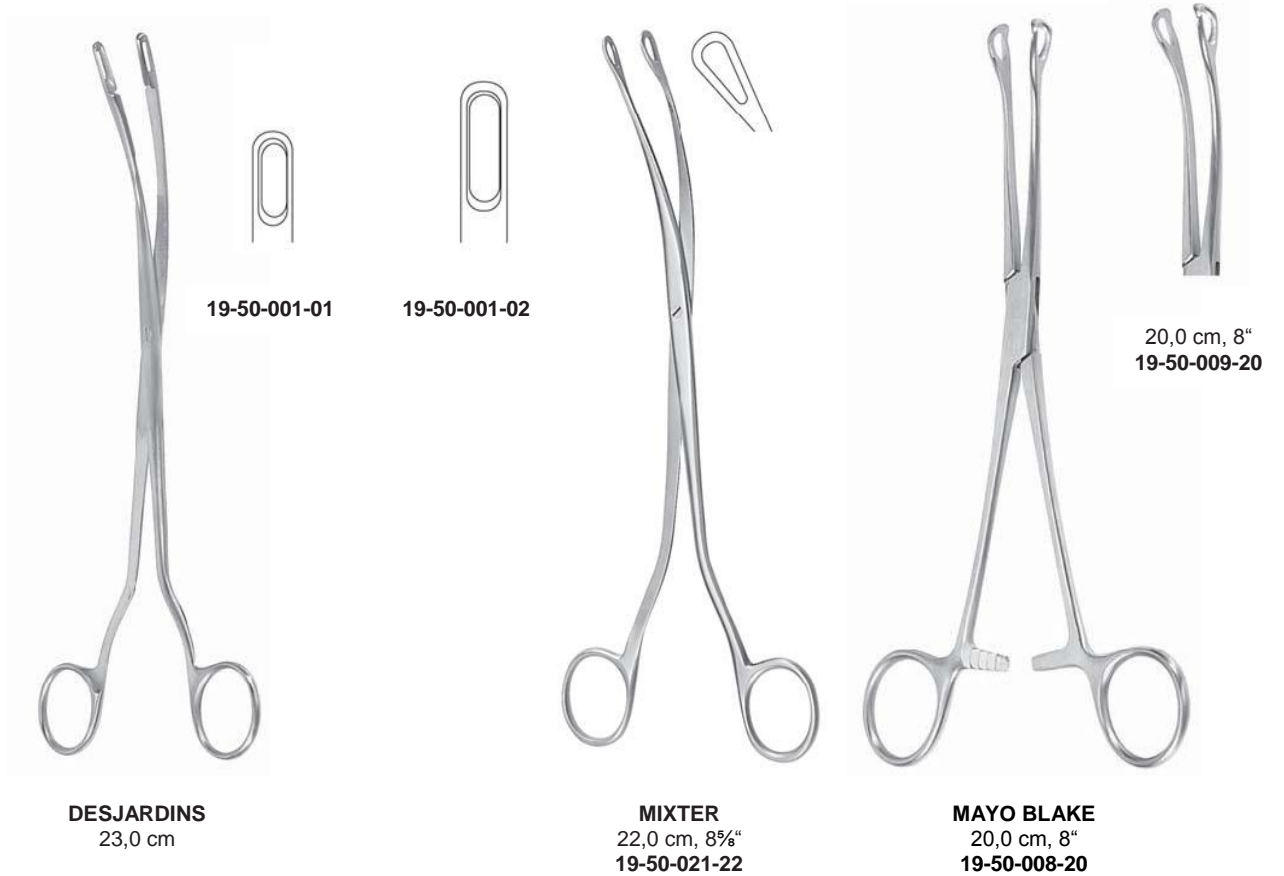
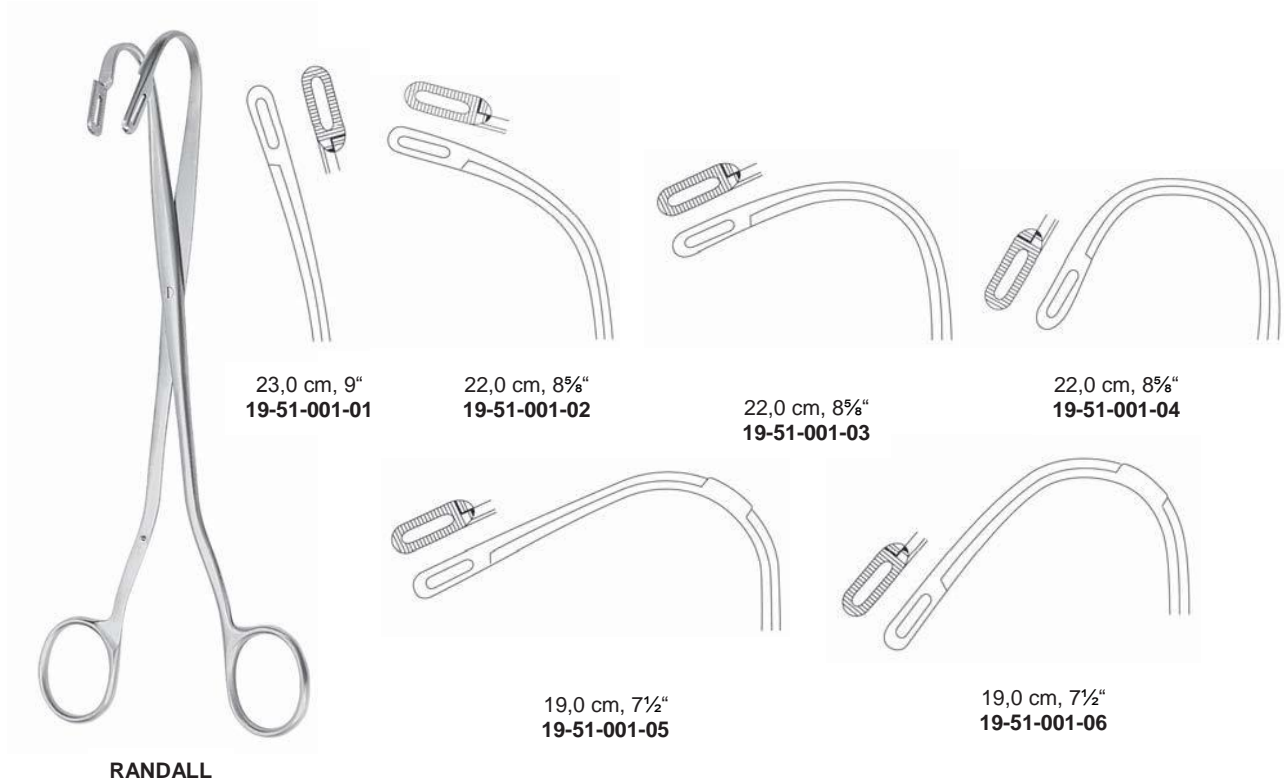



Gallensteinzangen  
 Gall Stone Forceps  
 Pincés pour calculs biliaires  
 Pinzas para cálculos biliares  
 Зажимы для желчных камней



**BLAKE**  
 20,0 cm, 8"  
 19-50-006-20

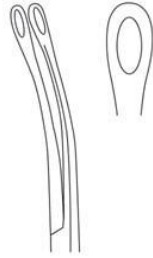

20,0 cm, 8"  
 19-50-005-20



**TURNER-WARWICK**  
 18,0 cm, 7"



19-50-031-01

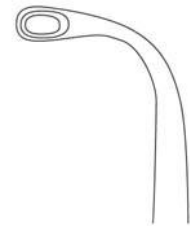

19-50-031-03



**CZERNY**  
 24,5 cm, 9 5/8"  
 19-50-039-24



Gallensteinlöffel  
 Gall Stone Scoops  
 Curettes pour calculs biliaires  
 Cucharillas para los cálculos biliares  
 Ложки для желчных камней



Schaft biegsam  
 shaft malleable  
 Tige malléable  
 Tige malleable  
 Гнущийся стержень

**LUER-KÖRTE**  
 27,0 cm, 10¾"



Fig. 000  
 2,5 mm  
**19-50-080-01**



Fig. 00  
 3,2 mm  
**19-50-080-02**



Fig. 0  
 4,2 mm  
**19-50-080-03**



Fig. 1  
 5,5 mm  
**19-50-080-04**



Fig. 2  
 6,7 mm  
**19-50-080-05**



Fig. 3  
 8,0 mm  
**19-50-080-06**



Fig. 4  
 11,0 mm  
**19-50-080-07**



Fig. 5  
 15,0 mm  
**19-50-080-08**



**FERGUSON**  
 21,5 cm, 8½"  
**19-50-070-01**



**MAYO**  
 27,0 cm, 10¾"  
**19-50-072-01**



**MAYO**  
 27,0 cm, 10¾"



**19-50-074-01**



**19-50-074-02**



**19-50-074-03**



**MOYNIHAN**  
 34,0 cm, 13¾"  
**19-50-076-34**

Gallengangsonden, Gallengang Dilatatore  
 Gall Duct Probes, Gall Duct Dilators  
 Sondes a calculs biliaires, Dilatateurs pour les voies biliaires  
 Sonas p.el conducto biliar, Dilatadores para el conducto biliar  
 Зонды для желчного протока, дилаторы желчного протока



**MAYO**  
 32,0 cm, 12½"  
 19-50-078-32



**OCHSNER**  
 35,0 cm, 13¾"  
 19-50-082-35



**DESJARDINS**  
 28,0 cm, 11"



13 Char.  
 19-50-056-13



18 Char.  
 19-50-056-18



21 Char.  
 19-50-056-21



**DESJARDINS**  
 28,0 cm, 11"

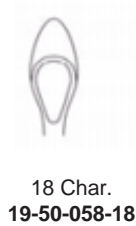

18 Char.  
 19-50-058-18



21 Char.  
 19-50-058-21



24 Char.  
 19-50-058-24



27 Char.  
 19-50-058-27



**MOORE**  
 30,0 cm, 12"  
 19-50-084-30

Gallensteinlöffel  
 Cuillère a calculs biliaires  
 Gall Stone Scoops  
 Cucharillas para los cálculos biliares  
 Ложки для желчных камней



Gallengang Dilatatoren  
Gall Duct Dilators  
Dilatateurs pour les voies biliaires  
Dilatadores para el conducto biliar  
Расширители для желчного протока

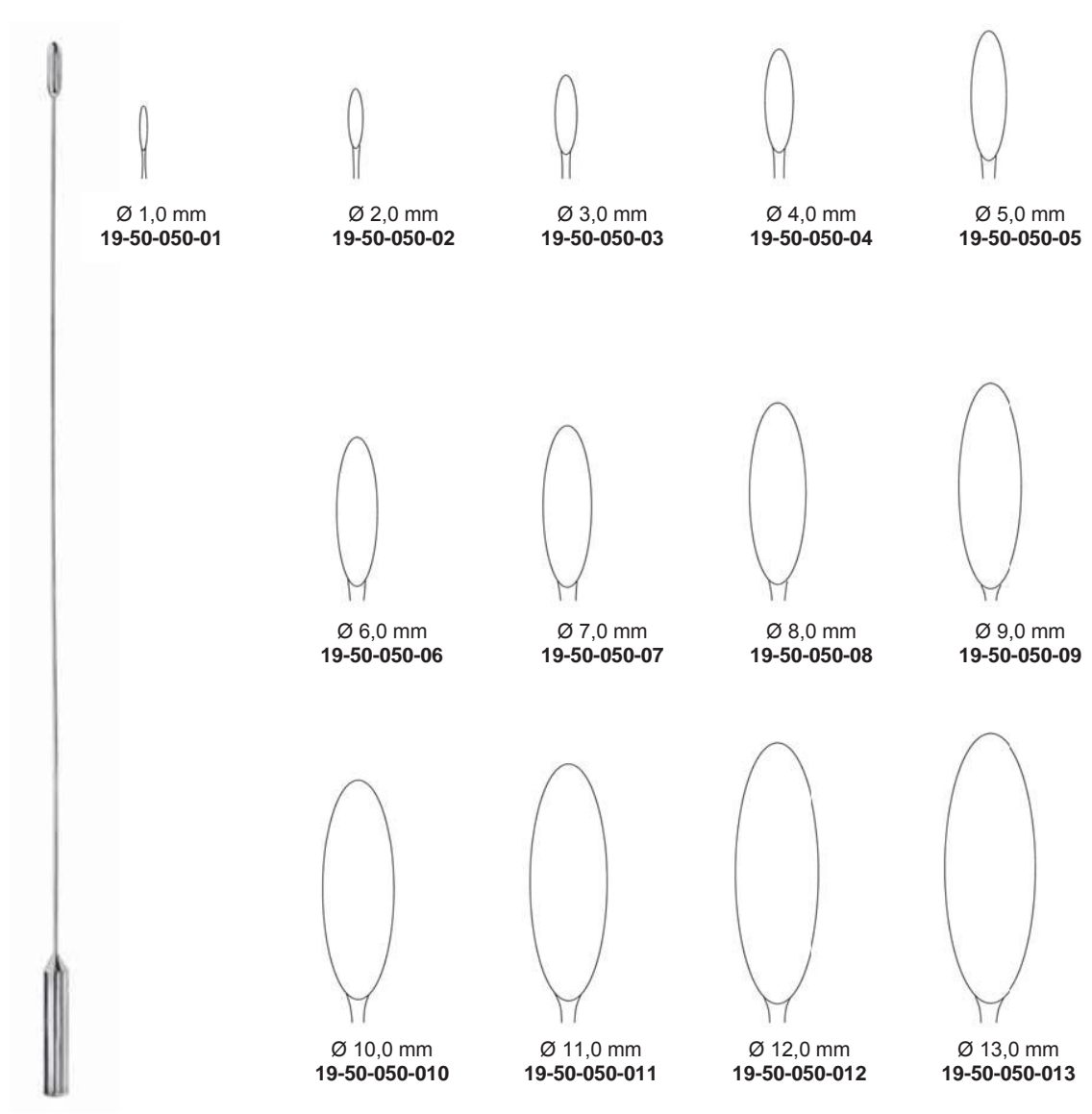

**BAKES**  
30,0 cm, 11¾"

**Blasenwundspreizer**  
**Bladder Retractors**  
**Ecarteurs vésicaux**  
**Separadores vesicales**  
**Ретракторы для мочевого пузыря**



**THOMSON-WALKER**  
**19-56-182-00**

57 x 25 mm **19-56-176-03**  
 80 x 25 mm **19-56-176-04**

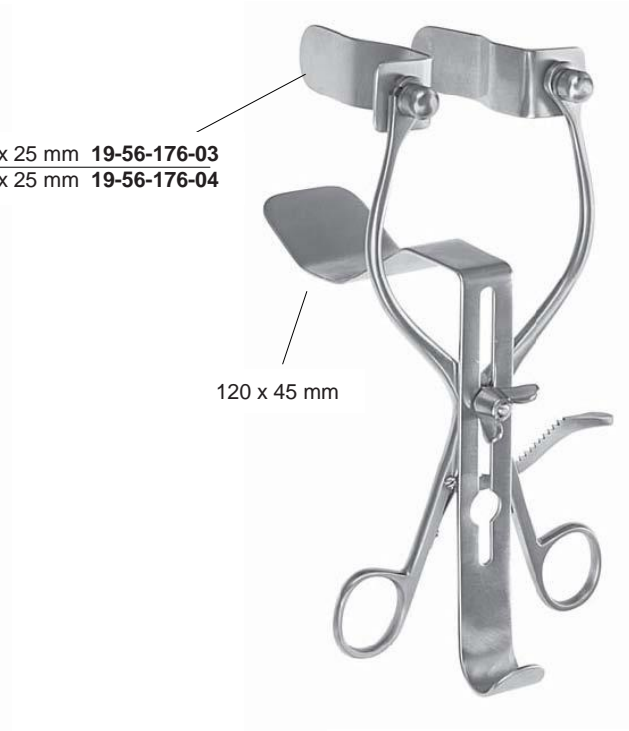

**MILLIN**  
**19-56-176-00**  
 komplett / complete / complet /  
 completo / комплект



**JUDD-MASSON**  
**19-56-172-00**



**LEGUEU**  
**19-56-160-00**

Instrumente für Prostatektomie  
 Prostatectomy Instruments  
 Pincés pour saisir les capsules  
 Instrumentos para la prostatectomía  
 Инструменты для удаления предстательной железы



**MILLIN**  
 23,0 cm, 9"  
 19-56-073-23



ATRAUMA

**MILLIN**  
 24,0 cm, 9½"  
 19-56-071-24



**MILLIN**  
 24,0 cm, 9½"  
 19-56-077-24



**MILLIN**  
 23,0 cm, 9"  
 19-56-075-23



**MILLIN**  
 28,5 cm, 11¼"  
 19-56-150-28

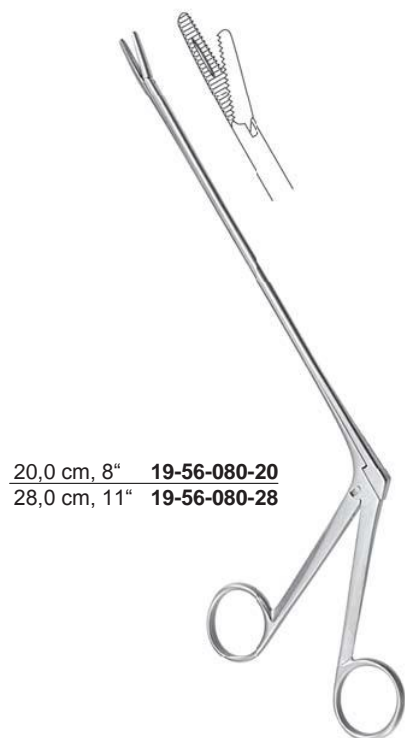

20,0 cm, 8" 19-56-080-20  
 28,0 cm, 11" 19-56-080-28

**MATHIEU**

Prostatahaken, Blasenspatel  
Prostatic Retractors, Bladder Spatulas  
Ecarteurs prostatiques, Spatule vésicale  
Separadores para la prostata, Separadores espatulas  
Расширители для предстательной железы,  
Шпатель для мочевого пузыря



**YOUNG**  
21,0 cm, 8¼"  
19-56-230-21



**YOUNG**  
22,0 cm, 8⅝"  
19-56-236-22



**YOUNG**  
21,0 cm, 8¼"  
19-56-238-21

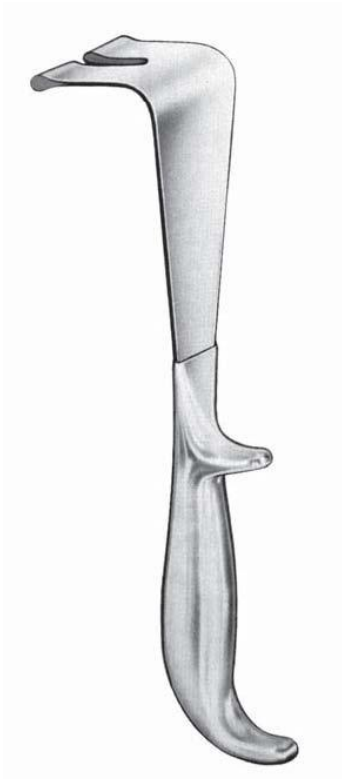

**YOUNG**  
22,0 cm, 8⅝"  
19-56-240-22



**LEGUEU**  
27,0 cm, 10¾"  
19-56-250-27



**KOCHER**  
26,0 cm, 10¼"  
19-56-257-26



van BUREN

- Char. 6 **19-56-620-06**
- Char. 8 **19-56-620-08**
- Char. 10 **19-56-620-10**
- Char. 12 **19-56-620-12**
- Char. 14 **19-56-620-14**
- Char. 16 **19-56-620-16**
- Char. 18 **19-56-620-18**
- Char. 20 **19-56-620-20**
- Char. 22 **19-56-620-22**
- Char. 24 **19-56-620-24**
- Char. 26 **19-56-620-26**
- Char. 28 **19-56-620-28**
- Char. 30 **19-56-620-30**
- Char. 32 **19-56-620-32**
- Char. 34 **19-56-620-34**
- Char. 36 **19-56-620-36**
- Char. 38 **19-56-620-38**
- Char. 40 **19-56-620-40**



29,0 cm, 11½"

für Männer  
for men  
pour hommes  
para hombres  
для мужчин

- Char. 8 **19-56-650-08**
- Char. 10 **19-56-650-10**
- Char. 12 **19-56-650-12**
- Char. 14 **19-56-650-14**
- Char. 16 **19-56-650-16**
- Char. 18 **19-56-650-18**
- Char. 20 **19-56-650-20**
- Char. 22 **19-56-650-22**
- Char. 24 **19-56-650-24**



16,0 cm, 6¼"

für Frauen  
for women  
pour femmes  
para mujeres  
для женщин

- Char. 8 **19-56-660-08**
- Char. 10 **19-56-660-10**
- Char. 12 **19-56-660-12**
- Char. 14 **19-56-660-14**
- Char. 16 **19-56-660-16**
- Char. 18 **19-56-660-18**
- Char. 20 **19-56-660-20**
- Char. 24 **19-56-660-24**



DITTEL

- Char. 8 **19-56-624-08**
- Char. 10 **19-56-624-10**
- Char. 12 **19-56-624-12**
- Char. 14 **19-56-624-14**
- Char. 16 **19-56-624-16**
- Char. 18 **19-56-624-18**
- Char. 20 **19-56-624-20**
- Char. 22 **19-56-624-22**
- Char. 24 **19-56-624-24**
- Char. 26 **19-56-624-26**
- Char. 28 **19-56-624-28**
- Char. 30 **19-56-624-30**



COXETER

- Char. 6 **19-56-614-06**
- Char. 8 **19-56-614-08**
- Char. 10 **19-56-614-10**
- Char. 12 **19-56-614-12**
- Char. 14 **19-56-614-14**
- Char. 16 **19-56-614-16**
- Char. 18 **19-56-614-18**
- Char. 20 **19-56-614-20**
- Char. 22 **19-56-614-22**
- Char. 24 **19-56-614-24**

Gleitsonde, Harnröhrenbougies, Circumcisions-Instrumente  
 Filiform Bougie, Urethral Sounds, Circumcision Instruments  
 Bougie conductrice, bougies urétrales, Instrument de circon-cision  
 Sonda filiforme, Bujias uretrales, Instrumentos circuncion  
 Катетеры мочевых путей, инструмент для обрезания



mit Schraubgewinde Ansatz  
 with screw thread  
 avec filet intérieur  
 avec about filete  
 с внутренней резьбой

- Char. 10 **19-56-612-10**
- Char. 12 **19-56-612-12**
- Char. 14 **19-56-612-14**
- Char. 16 **19-56-612-16**
- Char. 18 **19-56-612-18**
- Char. 20 **19-56-612-20**
- Char. 22 **19-56-612-22**
- Char. 24 **19-56-612-24**
- Char. 26 **19-56-612-26**
- Char. 28 **19-56-612-28**
- Char. 30 **19-56-612-30**



- Char. 6 **19-56-610-06**
- Char. 8 **19-56-610-08**
- Char. 10 **19-56-610-10**
- Char. 12 **19-56-610-12**
- Char. 14 **19-56-610-14**
- Char. 16 **19-56-610-16**
- Char. 18 **19-56-610-18**
- Char. 20 **19-56-610-20**
- Char. 22 **19-56-610-22**
- Char. 24 **19-56-610-24**
- Char. 26 **19-56-610-26**
- Char. 28 **19-56-610-28**
- Char. 30 **19-56-610-30**
- Char. 32 **19-56-610-32**
- Char. 34 **19-56-610-34**
- Char. 36 **19-56-610-36**
- Char. 38 **19-56-610-38**
- Char. 40 **19-56-610-40**

**GUYON**  
**19-56-660-00**  
 komplett/ complete/ complet/  
 completo/ комплект  
 10-30 Char.

**GUYON**



Penisklemme  
 Penis Clamp  
 Pince pour pénis  
 Clamp para pene  
 Зажим для полового члена



- Ø 8,0 mm **19-56-350-08**
- Ø 11,0 mm **19-56-350-11**
- Ø 13,0 mm **19-56-350-13**
- Ø 16,0 mm **19-56-350-16**
- Ø 21,0 mm **19-56-350-21**
- Ø 26,0 mm **19-56-350-26**
- Ø 32,0 mm **19-56-350-32**

**STRAUSS**  
 11,0 cm, 4 3/8"  
**19-56-349-11**

**STOCKMANN**  
 8,0 cm, 3 1/4"  
**19-56-345-08**



**COMCO**





Leicht  
Medizintechnik

**Magen, Darm, Mastdarm**  
**Stomach, Intestines, Rectum**  
**Estomac, Intestin, Rectum**  
**Estómago, Intestino, Recto**  
**Желудок, кишечник, прямая кишка**





Darm- und Gewebefasszangen  
 Intestinal and Tissue Grasping Forceps  
 Pinces a saisir les intestins et les tissus  
 Pinzas intestinales y para tejidos  
 Зажимы для кишечника и тканей



4 : 5

13,0 cm, 5" 21-52-000-13  
 14,0 cm, 5½" 21-52-000-14

ALLIS-BABY



4 : 5

16,0 cm, 6¾" 21-52-000-16  
 19,0 cm, 7½" 21-52-000-19  
 23,0 cm, 9" 21-52-000-23  
 25,0 cm, 10" 21-52-000-25  
 30,0 cm, 12" 21-52-000-30

5 : 6

16,0 cm, 6¾" 21-52-004-16  
 19,0 cm, 7½" 21-52-004-19  
 23,0 cm, 9" 21-52-004-23  
 25,0 cm, 10" 21-52-004-25  
 30,0 cm, 12" 21-52-004-30  
 35,0 cm, 14" 21-52-004-35

ALLIS



16,0 cm, 6¼" 21-54-124-16  
 20,0 cm, 8" 21-54-124-20  
 25,0 cm, 9¾" 21-54-124-25  
 30,0 cm, 11¼" 21-54-124-30

ALLIS-ATRAUMA



15,5 cm, 6" 21-52-020-15  
 20,0 cm, 8" 21-52-020-20  
 23,0 cm, 9" 21-52-020-23

ALLEN

Darm- und Gewebefasszangen  
 Intestinal and Tissue Grasping Forceps  
 Pincers a saisir les intestins et les tissus  
 Pinzas intestinales y para tejidos  
 Зажимы для кишечника и тканей



12,5 cm, 5" **21-52-030-12**  
 15,0 cm, 6" **21-52-030-15**  
 19,5 cm, 7¾" **21-52-030-19**

LANE

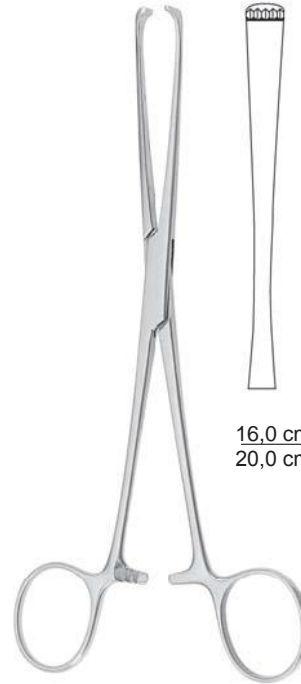

16,0 cm, 6¼" **21-52-178-16**  
 20,0 cm, 8" **21-52-178-20**

LOCKWOOD-ALLIS



16,0 cm, 6½" **21-52-040-16**  
 20,0 cm, 8" **21-52-040-20**

JUDD-ALLIS



18,5 cm, 7¼" **21-52-060-18**

LITTLEWOOD



15,5 cm, 6" **21-52-010-15**

ALLIS-ADAIR

Darm- und Gewebefasszangen  
 Intestinal and Tissue Grasping Forceps  
 Pinces a saisir les intestins et les tissus  
 Pinzas intestinales y para tejidos  
 Зажимы для кишечника и тканей



**BOYS-ALLIS**  
 15,5 cm, 6"  
 21-52-012-15



**THOMS-ALLIS**  
 20,0 cm, 8"  
 21-52-050-20



**ALLIS**  
 20,0 cm, 8"  
 21-52-014-20



**LOCKWOOD**  
 20,0 cm, 8"  
 21-52-176-20



**WILLIAMS**  
 16,0 cm, 6¼"  
 21-52-070-16

Darm- und Gewebefasszangen  
 Intestinal and Tissue Grasping Forceps  
 Pincers a saisir les intestins et les tissus  
 Pinzas intestinales y para tejidos  
 Зажимы для кишечника и тканей



16,0 cm, 6¼" 21-52-006-16  
 18,0 cm, 7" 21-52-006-18  
 20,0 cm, 8" 21-52-006-20  
 24,0 cm, 9½" 21-52-006-24

BABCOCK



16,0 cm, 6¼" 21-54-006-16  
 20,0 cm, 8" 21-54-006-20

BABCOCK-ATRAUMA



16,0 cm, 6¼" 21-53-006-16  
 20,0 cm, 8" 21-53-006-20  
 24,0 cm, 9½" 21-53-006-24

BABCOCK-TC



DUVAL-TC  
 20,0 cm, 8"  
 21-53-170-20



Darmklemmen  
 Intestinal Clamp Forceps  
 Pincers intestinales  
 Pinzas-clamps intestinales  
 Зажимы кишечные



**DUVAL**

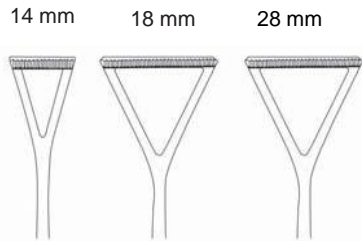

18,0 cm, 7"	<b>21-52-170-18</b>	-	-
20,0 cm, 8"	<b>21-52-170-20</b>	<b>21-52-171-20</b>	<b>52-172-20</b>
23,0 cm, 9"	<b>21-52-170-23</b>	<b>21-52-171-23</b>	<b>52-172-23</b>

Darm- und Gewebefasszangen  
 Intestinal and Tissue Grasping Forceps  
 Pincers a saisir les intestins et les tissus  
 Pinzas intestinales y para tejidos  
 Зажимы для кишечника и тканей



**BABY-DOYEN TC**  
 18,0 cm, 7"

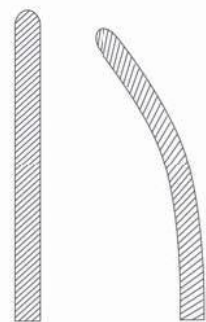

16,0 cm, 6 <sup>3</sup> / <sub>4</sub> "	<b>21-52-200-16</b>	<b>21-52-201-16</b>
18,0 cm, 7"	<b>21-52-200-18</b>	<b>21-52-201-18</b>



**DOYEN**

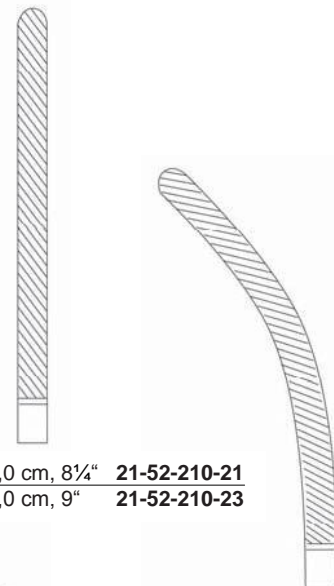

21,0 cm, 8 <sup>1</sup> / <sub>4</sub> "	<b>21-52-210-21</b>
23,0 cm, 9"	<b>21-52-210-23</b>

21,0 cm, 8 <sup>1</sup> / <sub>4</sub> "	<b>21-52-211-21</b>
23,0 cm, 9"	<b>21-52-211-23</b>

Darmklemmen  
 Intestinal Clamp Forceps  
 Pincas intestinales  
 Pinzas-clamps intestinales  
 Зажимы кишечные



DOYEN

mit atraumatischer Zahnung  
 with atraumatic serration  
 atraumatiques  
 con bacos atraumáticas  
 с атравматичной зазубренностью

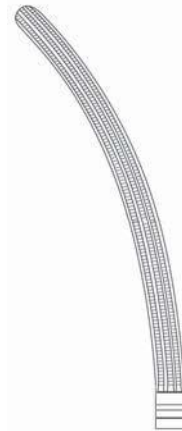

- 13,0 cm, 5" **21-54-210-13**
- 16,0 cm, 6<sup>3</sup>/<sub>4</sub>" **21-54-210-16**
- 18,0 cm, 7" **21-54-210-18**
- 21,0 cm, 8<sup>1</sup>/<sub>4</sub>" **21-54-210-21**
- 23,0 cm, 9" **21-54-210-23**

- 13,0 cm, 5" **21-54-211-13**
- 16,0 cm, 6<sup>3</sup>/<sub>4</sub>" **21-54-211-16**
- 18,0 cm, 7" **21-54-211-18**
- 21,0 cm, 8<sup>1</sup>/<sub>4</sub>" **21-54-211-21**
- 23,0 cm, 9" **21-54-211-23**



KOCHER



- 22,0 cm, 8<sup>5</sup>/<sub>8</sub>" **21-52-234-22**
- 25,0 cm, 9<sup>3</sup>/<sub>4</sub>" **21-52-234-25**
- 28,0 cm, 11" **21-52-234-28**

- 22,0 cm, 8<sup>5</sup>/<sub>8</sub>" **21-52-235-22**
- 25,0 cm, 9<sup>3</sup>/<sub>4</sub>" **21-52-235-25**
- 28,0 cm, 11" **21-52-235-28**





Darmklemmen  
Intestinal Clamp Forceps  
Pinces intestinales  
Pinzas-clamps intestinales  
Зажимы кишечные



KOCHER

mit atraumatischer Zahnung  
with atraumatic serration  
atraumatiques  
con bacos atraumáticas  
с атравматичной зазубренностью

22,0 cm, 8<sup>5</sup>/<sub>8</sub>" 21-54-234-22  
25,0 cm, 9<sup>3</sup>/<sub>4</sub>" 21-54-234-25  
28,0 cm, 11" 21-54-234-28



22,0 cm, 8<sup>5</sup>/<sub>8</sub>" 21-54-235-22  
25,0 cm, 9<sup>3</sup>/<sub>4</sub>" 21-54-235-25  
28,0 cm, 11" 21-54-235-28



MAYO-ROBSON

21,0 cm, 8<sup>1</sup>/<sub>4</sub>" 21-52-230-21 21-52-231-21  
23,0 cm, 9" 21-52-230-23 21-52-231-23  
25,0 cm, 9<sup>3</sup>/<sub>4</sub>" 21-52-230-25 21-52-231-25  
28,0 cm, 11" 21-52-230-28 21-52-231-28

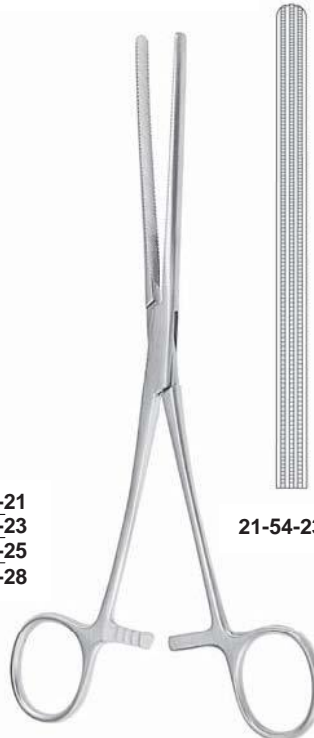

MAYO-ROBSON  
25,0 cm, 9<sup>3</sup>/<sub>4</sub>"

mit atraumatischer Zahnung  
with atraumatic serration  
atraumatiques  
con bacos atraumáticas  
с атравматичной зазубренностью

21-54-230-25

21-54-231-25

Darmklemmen  
 Intestinal Clamp Forceps  
 Pinces intestinales  
 Pinzas-clamps intestinales  
 Зажимы кишечные



**BRUNNER**  
 24,0 cm, 9½"  
 21-52-240-24

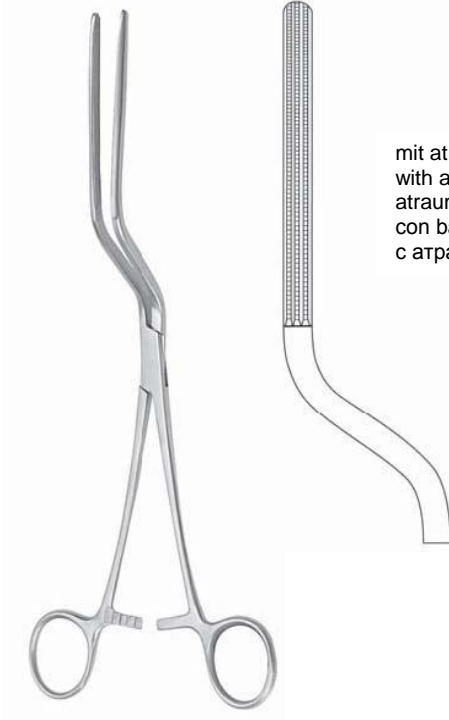

**BRUNNER**  
 24,0 cm, 9½"  
 21-54-240-24

mit atraumatischer Zahnung  
 with atraumatic serration  
 atraumatiques  
 con bacos atraumáticos  
 с атравматичной зазубренностью



**GLASSMAN**  
 23,0 cm, 9"  
 21-52-259-23



**GLASSMAN**  
 23,5 cm, 9¼"  
 21-52-253-23

Darm- und Magenquetschklemmen  
 Intestinal and Stomach Clamps  
 Pincers -clamps intestinales et d'estomac  
 Pinzas-clamps intestinales y estomacales  
 Зажимы кишечные и желудочные



Maullänge  
 length of jaws  
 bouche en longueur  
 longitud de la boca  
 длина браншей

5,0 cm, 2" 21-52-320-05  
 7,0 cm, 2½" 21-52-320-07  
 10,0 cm, 4" 21-52-320-10

DE MARTEL-WOLFSON



DE MARTEL-WOLFSON  
 8,5 cm, 3½"  
 21-52-340-08



DE MARTEL-WOLFSON  
 26,0 cm, 10¼"  
 21-52-325-26



BABY-PAYR  
 15,0 cm, 6"



21-52-310-15

mit Stift  
 with pin  
 avec rayon  
 con espiga  
 со штифтом



21-52-311-15

ohne Stift  
 without pin  
 senza perno  
 sin espiga  
 без штифта



PAYR



21,0 cm, 8¼"  
 29,0 cm, 11½"  
 35,0 cm, 14"

mit Stift  
 with pin  
 avec rayon  
 con espiga  
 со штифтом



21-52-310-21 21-52-311-21  
 21-52-310-29 21-52-311-29  
 21-52-310-35 21-52-311-35

ohne Stift  
 without pin  
 senza perno  
 sin espiga  
 без штифта

Darm- und Magenklappen  
 Intestinal and Stomach Clamp Forceps  
 Pincers-clamps intestinales et d'estomac  
 Pinzas-clamps intestinales y estomacales  
 Зажимы кишечные и желудочные

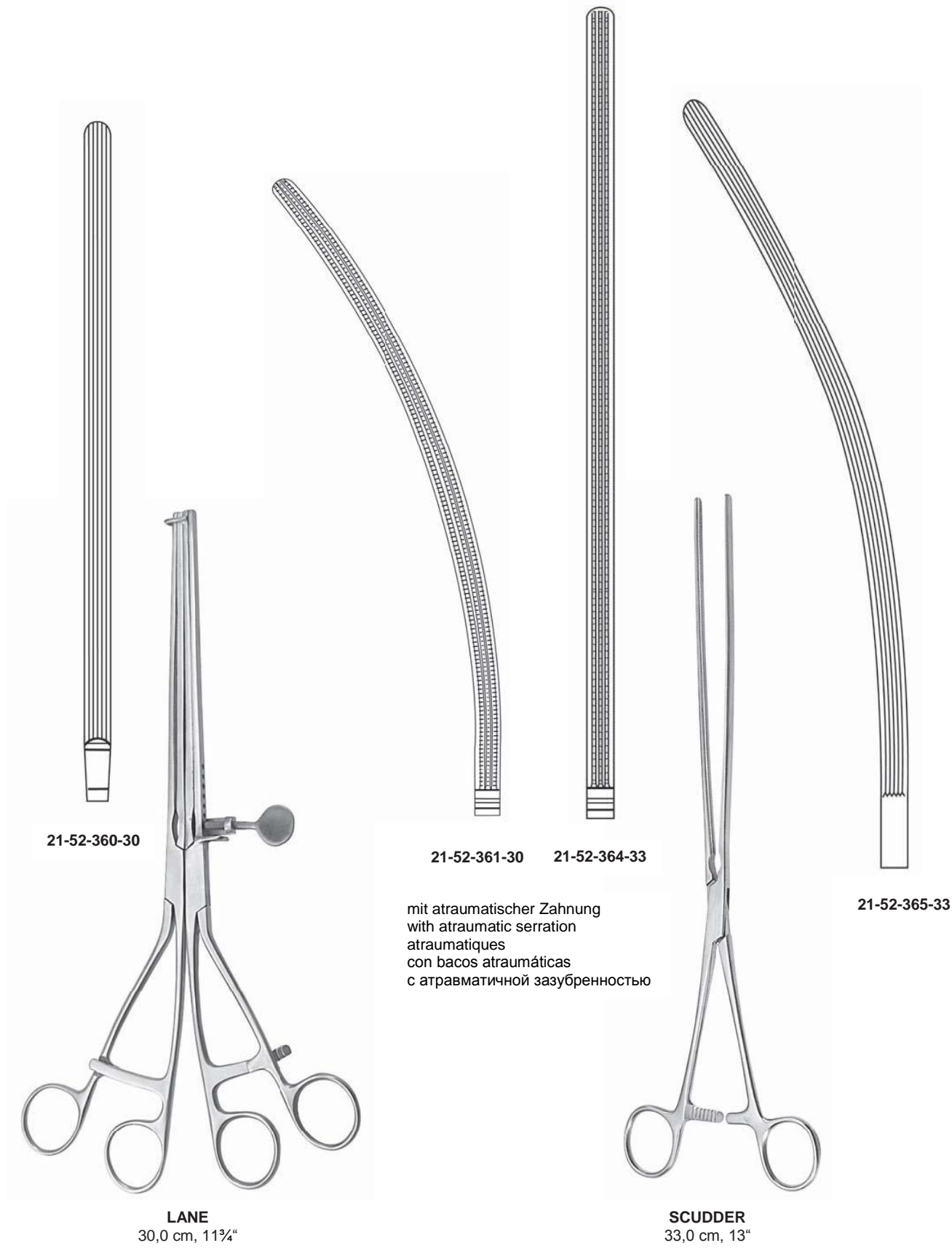



Rektum-Anastomosenklemmen  
Sigmoid Anastomosis Forceps  
Pinces a Anastomose Rectale  
Pinzas para anastomosis de recto  
Зажим для сигмовидного анастомоза



**MIKULICZ**  
19,0 cm, 7½"  
21-55-010-19

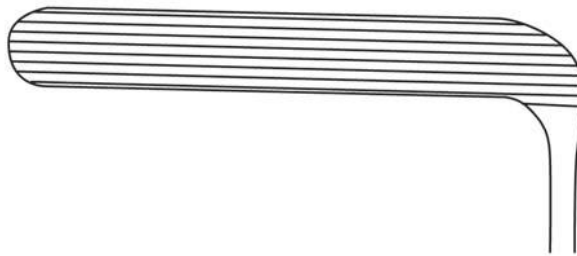

**HAYES**

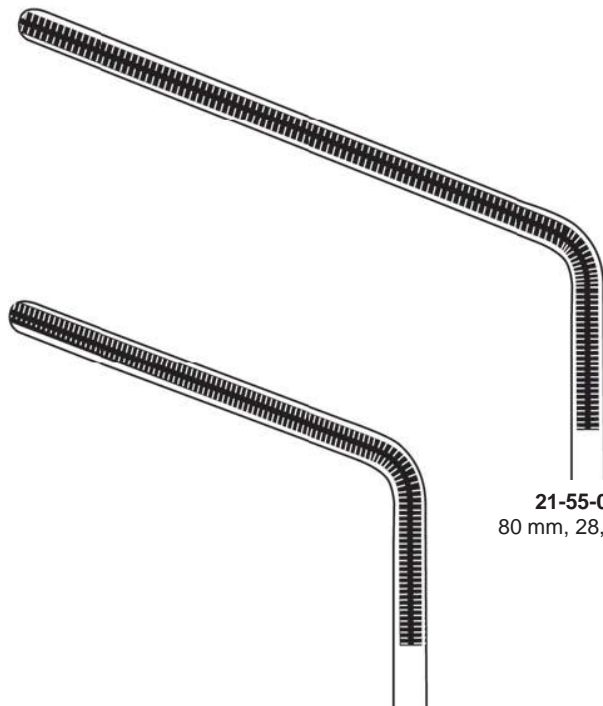

**21-55-020-28**  
80 mm, 28,0 cm 11"

**21-55-020-26**  
55 mm, 26,0 cm 10"

**Mastdarm-Rektum-Spekula**  
**Rectal Specula**  
**Ecarteurs Rectaux**  
**Espécúlos para el recto**  
**Расширители ректальные**



17 x 89 mm

**SIMS**  
 15,0 cm, 6"  
 21-55-108-15



17 x 89 mm

**SIMS**  
 15,0 cm, 6"  
 21-55-110-15



25 x 89 mm

**MATHIEU**  
 21,0 cm, 8¼"  
 21-55-150-21



75 x 23 mm

**SMITH-BUIE**  
 15,0 cm, 6"  
 21-55-160-15



**Analspreizer  
Rectal Retractor  
Ecarteurs Rectaux  
Separadores para el recto  
Ректальный ретрактор**

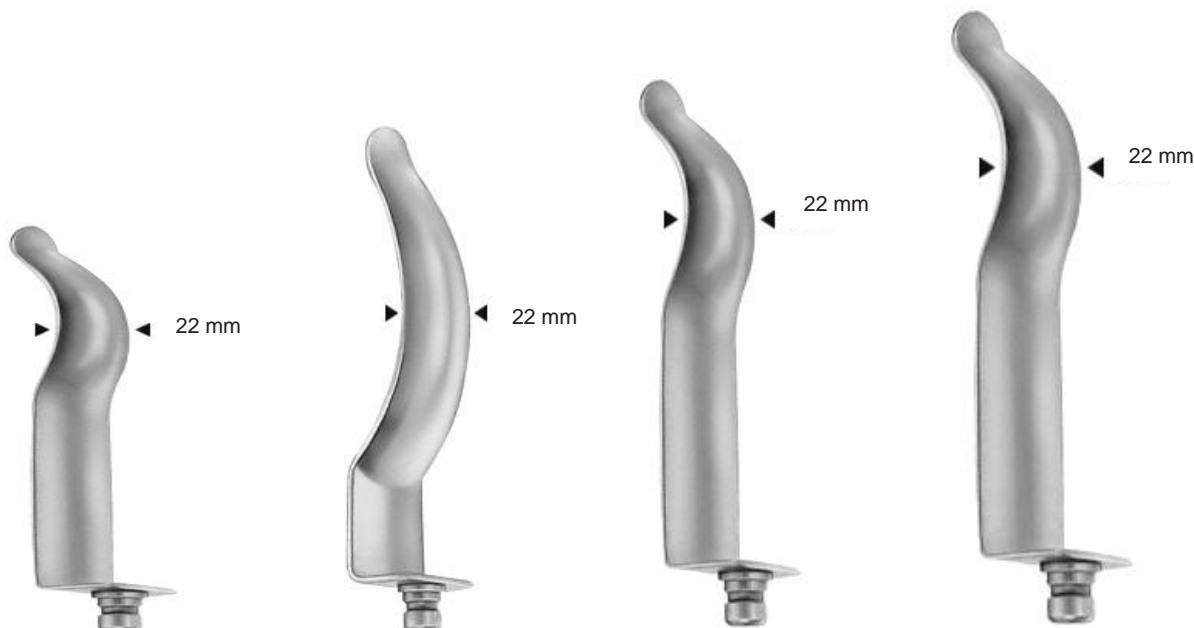

**21-55-147-70**  
Rectum Blätter  
rectal blades  
paire de valves rectales  
pare de valvas rectales  
ректальные лопатки  
70 mm tief/deep/profondeur/  
profondite/глубина

**21-55-147-93**  
Sphincter Blätter  
sphincter blades  
paire de valves sphincter  
pare de valvas esfínter  
лопатки сфинктерные  
93 mm tief/deep/profondeur/  
profondite/глубина

**21-55-147-90**  
Blätter für Anastomosen  
Blades for anastomosis  
paire de valves anastomoses  
pare de valvas anastomosis  
лопатки для соустья  
90 mm tief/deep/profondeur/  
profondite/глубина

**21-55-147-15**  
Blätter für Anastomosen  
Blades for anastomosis  
paire de valves anastomoses  
pare de valvas anastomosis  
лопатки для соустья  
150 mm tief/deep/profondeur/  
profondite/глубина



**21-55-147-02**

**21-55-147-03**  
Mittelblatt, center blade,  
valve central, центральный шпатель  
1 Stück

**PARKS**  
13,5 cm, 5%“

**PARKS  
21-55-147-00**

komplett, ohne Kaltlichtanschluß  
complete, without cold light connector  
complet, sans support lumière froide  
completo, sin portador para luz fría  
в комплекте, без светодиода

komplett, bestehend aus:  
complete, consisting of:  
jeu se composant de:  
completo, compuesto of:  
комплект состоит из:

**21-55-147-70**  
**21-55-147-93**  
1 Paar Blätter/2 pairs of blades/2 pares de valvas/  
2 paires de valves/ 1 пара лопаток

**21-55-147-02**  
1 Sperrer allein/only Spreader/Separador suelto/  
Ecarteur seul / только рамка

**21-55-147-03**  
1 Mittelblatt /Central blade /valva central/  
valve central / центральный шпатель

**PARKS  
21-55-147-01**

komplett, mit Kaltlichtanschluß  
complete, with cold light connector  
complet, avec support lumière froide  
completo, con portador para luz fría  
в комплекте, со световодом

Anuskope  
Anoscope  
Anoscopes  
Anoscopios  
Анускоп



Ø 16 x 65 mm 21-55-212-01  
Ø 19 x 65 mm 21-55-212-02  
Ø 22 x 65 mm 21-55-212-03

HIRSCHMANN



Ø 22 x 50 mm 21-55-280-01  
Ø 22 x 100 mm 21-55-280-02  
Ø 22 x 140 mm 21-55-280-03  
Ø 22 x 200 mm 21-55-280-04

KELLY



Ø 21 x 50 mm 21-55-285-01  
Ø 27 x 50 mm 21-55-285-02

KELLY





CHELSEA EATON

Ø 22 x 65 mm 21-55-250-22  
Ø 30 x 65 mm 21-55-250-30



**IVES FANSLER**  
Ø 22 mm  
21-55-268-01

ohne Kaltlichtträger  
without cold light carrier  
sans support lumière froide  
sin portador para luz fría  
без держателя световодного  
кабеля

**IVES FANSLER**  
Ø 22 mm  
21-55-268-02

mit Kaltlichtträger  
with cold light carrier  
avec support lumière froide  
con portador para luz fría  
с держателем световодного  
кабеля



Ø 17 x 60 mm 21-55-220-01  
Ø 17 x 80 mm 21-55-220-02  
Ø 20 x 65 mm 21-55-220-03  
Ø 20 x 80 mm 21-55-220-04  
Ø 24 x 65 mm 21-55-220-05  
Ø 24 x 80 mm 21-55-220-06

MORGAN



21-55-220-00  
**KALTLICHT**  
**COLD LIGHT CARRIER**  
support lumière froide

Aufsatz allein  
Spare fire light Attachment  
Adapteur lumière froide seul  
Cabeza de luz fría suelta  
только насадка

**Mastdarm-Biopsiezangen**  
**Rectal Biopsy Forceps**  
**Pinces pour Biopsie Rectale**  
**Pinzas sacabocado para biopsia rectal**  
**Биопсийные ректальные щипцы**

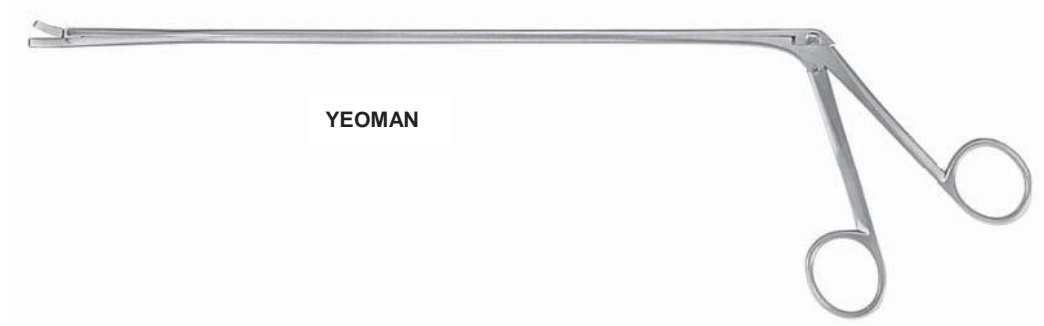

YEOMAN



Fig: 1

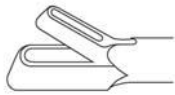

28,0 cm, 11" **21-55-300-28**  
 35,0 cm, 13¾" **21-55-300-35**  
 42,0 cm, 16½" **21-55-300-42**

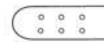

Fig: 2



28,0 cm, 11" **21-55-311-28**  
 35,0 cm, 13¾" **21-55-311-35**  
 42,0 cm, 16½" **21-55-311-42**



Fig: 3

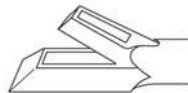

28,0 cm, 11" **21-55-301-28**  
 35,0 cm, 13¾" **21-55-301-35**  
 42,0 cm, 16½" **21-55-301-42**



Fig: 4

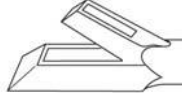

28,0 cm, 11" **21-55-312-28**  
 35,0 cm, 13¾" **21-55-312-35**  
 42,0 cm, 16½" **21-55-312-42**



Ø 12,0 mm

**Hämorrhoiden-Ligator mit Ladekonus**  
**Haemorrhoidal ligator with loading attachment**  
**Ligateur pour Hémorroïdes avec cône de charge**  
**Ligador para hemorroides con cono de carga**  
**Геморроидальный лигатор с накладкой**

**RUDD**  
**21-55-400-00**

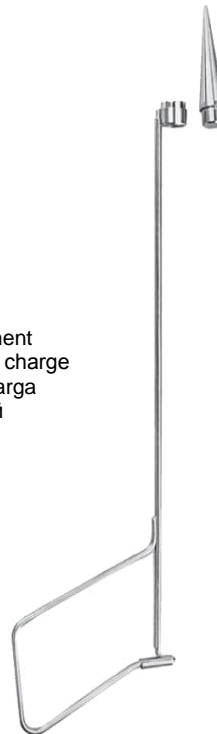

Ø 12,0 mm

**MC GIVNEY**  
**21-55-410-00**



Hämorrhoiden-Fasszangen, Fistelsonden  
Haemorrhoidal Forceps, Fistula probes  
Pinces pour Hémorroïdes, Sondas pour fistule  
Pinza-clamps para hemorroides, Sondas para fistula  
Геморроидальные щипцы, крючок для фистулы



**MC GIVNEY**  
19,0 cm, 7½"  
21-55-473-19

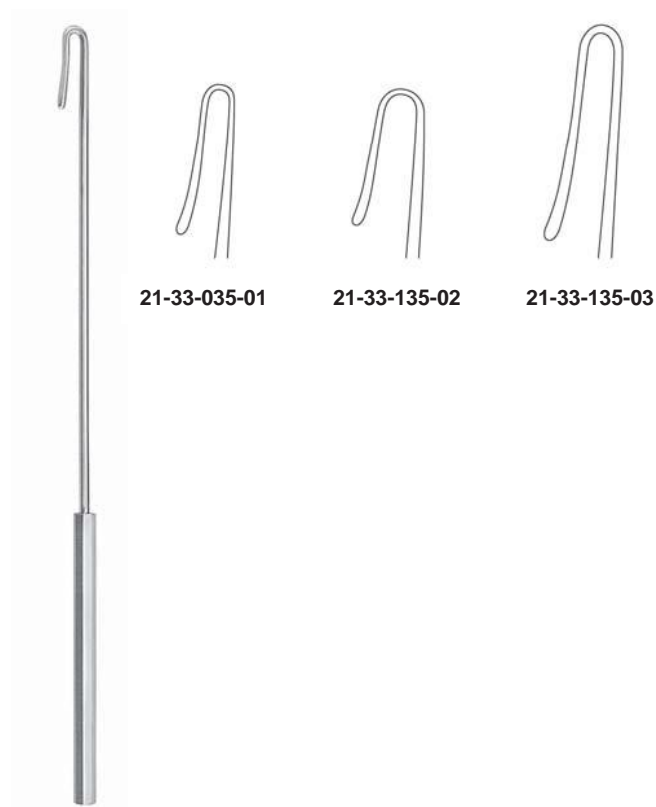

**PRATT**  
21,0 cm, 8¼"

21-33-035-01

21-33-135-02

21-33-135-03



Leicht  
Medizintechnik

**Gynäkologie, Geburtshilfe**  
**Gynaecology, Obstetrics**  
**Gynécologie, Obstétrique**  
**Ginecología, Obstetricia**  
**Гинекология, акушерство**







Vaginalspekula  
Vaginal Specula  
Speculums vaginaux  
Especulos vaginales  
Зеркала гинекологические

für Kinder  
for children  
pour enfants  
para niños  
для детей



**COLLIN**  
65 x 10 mm  
23-57-134-00

für Jungfrauen  
for virgins  
pour vierge  
para virgenes  
для девственниц



**COLLIN**  
65 x 20 mm  
23-57-132-00

für Jungfrauen  
for virgins  
pour vierge  
para virgenes  
для девственниц



**COLLIN**  
85 x 30 mm 23-57-130-01  
100 x 35 mm 23-57-130-02  
110 x 40 mm 23-57-130-03



**CUSCO**  
75 x 17 mm  
23-57-144-00

Vaginalspekula  
 Vaginal Specula  
 Speculums vaginaux  
 Espécules vaginales  
 Зеркала гинекологические

zentrale Stellschraube  
 central fixation screw  
 vis centrale  
 tornillo de sujeto central  
 винт центральной фиксации



**CUSCO**  
 75 x 32 mm **23-57-144-01**  
 85 x 36 mm **23-57-144-02**  
 95 x 37 mm **23-57-144-03**  
 100 x 35 mm **23-57-144-04**

seitliche Stellschraube  
 lateral fixation screw  
 vis latérale  
 tornillo de sujeto lateral  
 винт боковой фиксации



für Jungfrauen  
 for virgins  
 pour vierge  
 para virgenes  
 для девственниц

**CUSCO**  
 85 x 17 mm  
**23-57-140-00**

seitliche Stellschraube  
 lateral fixation screw  
 vis latérale  
 tornillo de sujeto lateral  
 винт боковой фиксации



**CUSCO**  
 75 x 32 mm **23-57-140-01**  
 85 x 35 mm **23-57-140-02**  
 100 x 35 mm **23-57-140-03**  
 80 x 24 mm **23-57-140-11**

Schweizer Modell  
 Swiss pattern  
 modèle suisse  
 Modelo suizo  
 Швейцарская модель



**CUSCO**  
 90 x 23-25 mm **23-57-146-01**  
 100 x 25-27 mm **23-57-146-02**  
 110 x 27-30 mm **23-57-146-03**



**GRAVE**  
75 x 20 mm **23-57-100-01**  
95 x 35 mm **23-57-100-02**  
115 x 35 mm **23-57-100-03**



**PEDERSON**  
175 x 13 mm **23-57-120-01**  
100 x 22 mm **23-57-120-02**  
120 x 25 mm **23-57-120-03**

100 x 16 mm **23-57-120-04** schlank  
slender  
etroit  
estrecho  
узкая модель



**SEMM**  
100 x 17-20 mm **23-57-150-02**  
100 x 25-30 mm **23-57-150-03**



**WEISSBARTH**  
21,0 cm, 8¼"  
**23-57-160-00**

komplett mit abnehmbaren Luftfangkorb  
complete with detechable strainer  
complet avec tamis démontable  
completo con tamiz desmontable  
комплект со съёмной коробочкой



Vaginalspekula  
 Vaginal Specula  
 Speculums vaginaux  
 Espécules vaginales  
 Зеркала гинекологические



mit abnehmbarem Gewicht  
 with detachable weight  
 poids démontable  
 con peso desmontable  
 со съёмным весом

**AUVARD**  
 75 x 38 mm **23-57-170-11**  
 105 x 40 mm **23-57-170-10**



mit festem Gewicht  
 with fixed weight  
 poids fixe  
 con peso fi jo  
 с фиксированным весом

**AUVARD**  
 75 x 38 mm **23-57-170-21**  
 105 x 40 mm **23-57-170-20**



**23-57-180-03**  
 Griff allein  
 handle only  
 Manche pour  
 Mango suelto  
 только ручка

400 g **23-57-180-40**  
 800 g **23-57-180-80**

Gewicht allein  
 weight only  
 Poids pour  
 Pesa suelto  
 только груз

**SCHERBACK**  
**23-57-180-00**  
 komplett, complete, complet,  
 completo, в комплекте

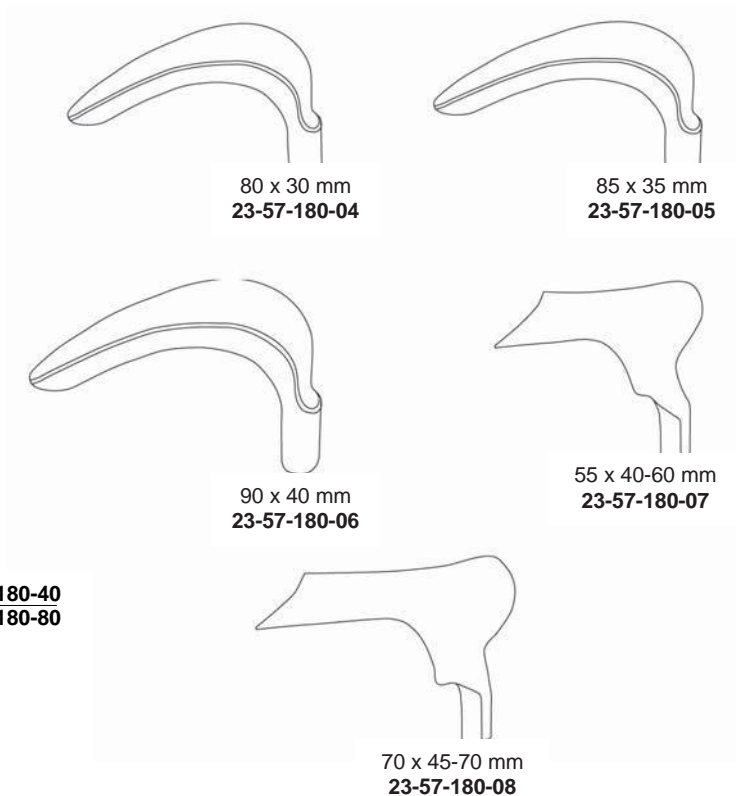



Satz  
Set  
Jeu  
Juego  
Набор

**KRISTELLER**  
Fig. 1 **23-57-220-01**  
Fig. 2 **23-57-220-02**  
Fig. 3 **23-57-220-03**



Spekula allein, flach  
Specula only, flat hollow  
Espéculos suelto,  
con huecos planos  
Speculums seul, plats  
только зеркало,  
плоско-вогнутое

**KRISTELLER**  
105 x 26 mm **23-57-221-01**  
105 x 28 mm **23-57-221-02**  
105 x 33 mm **23-57-221-03**



Halter allein  
Retractors only  
valves vaginales seul  
Valvas suelto  
только ретракторы

**KRISTELLER**  
115 x 22 mm **23-57-222-01**  
115 x 24 mm **23-57-222-02**  
115 x 29 mm **23-57-222-03**



Satz  
Set  
Jeu  
Juego  
Набор

**KRISTELLER**  
Fig. 1 **23-57-230-01**  
Fig. 2 **23-57-230-02**  
Fig. 3 **23-57-230-03**



Spekula allein, flach  
Specula only, flat hollow  
Espéculos suelto,  
con huecos planos  
Speculums seul, plats  
только зеркало,  
плоско-вогнутое

**KRISTELLER**  
110 x 27 mm **23-57-231-01**  
110 x 30 mm **23-57-231-02**  
110 x 36 mm **23-57-231-03**



Halter allein  
Retractors only  
valves vaginales seul  
Valvas suelto  
только ретракторы

**KRISTELLER**  
115 x 23 mm **23-57-232-01**  
115 x 26 mm **23-57-232-02**  
115 x 32 mm **23-57-232-03**

Vaginalspekula  
 Vaginal Specula  
 Speculums vaginaux  
 Espécules vaginales  
 Зеркала гинекологические



Satz  
 Set  
 Jeu  
 Juego  
 Набор

**KRISTELLER**  
 Fig. 0 **23-57-234-00**  
 Fig. 1 **23-57-234-01**  
 Fig. 2 **23-57-234-02**  
 Fig. 3 **23-57-234-03**



Spekula allein  
 Specula only  
 Speculums seul  
 Espécules suelto  
 только зеркало

**KRISTELLER**  
 70 x 15 mm **23-57-235-00**  
 70 x 27 mm **23-57-235-01**  
 80 x 30 mm **23-57-235-02**  
 90 x 36 mm **23-57-235-03**



Halter allein  
 Retractors only  
 valves vaginale, seul  
 Valvas suelto  
 только ретракторы

**KRISTELLER**  
 175 x 10 mm **23-57-236-00**  
 175 x 23 mm **23-57-236-01**  
 185 x 26 mm **23-57-236-02**  
 100 x 32 mm **23-57-236-03**

konisch, für Jungfrauen  
 conical blades, for virgins  
 valve coniche, pour vierge  
 valvos cónicos, para vírgenes  
 конические шпатели, для  
 девственниц



Satz  
 Set  
 Jeu  
 Juego  
 Набор

**KRISTELLER**  
 Fig. 00 **23-57-237-01**  
 Fig. 0 **23-57-237-02**



Spekula allein  
 Specula only  
 Speculums seul  
 Espécules suelto  
 только зеркало

**KRISTELLER**  
 105 x 18 mm **23-57-238-01**  
 105 x 21 mm **23-57-238-02**



Halter allein  
 Retractors only  
 valves vaginale seul  
 Valvas suelto  
 только ретракторы

**KRISTELLER**  
 110 x 14 mm **23-57-239-01**  
 110 x 17 mm **23-57-239-02**



leicht hohl  
slightly-concave  
légèrement concave  
ligeremente concavos  
незначительно вогнутое

**Fig. a x b**

- 1 60 x 35 mm **23-57-267-01**
- 2 90 x 35 mm **23-57-267-02**
- 3 120 x 35 mm **23-57-267-03**

- 1 60 x 45 mm **23-57-268-01**
- 2 90 x 45 mm **23-57-268-02**
- 3 120 x 45 mm **23-57-268-03**
- 4 160 x 45 mm **23-57-261-04**

- 1 60 x 60 mm **23-57-269-01**
- 2 90 x 60 mm **23-57-269-02**
- 3 120 x 60 mm **23-57-269-03**
- 4 160 x 60 mm **23-57-262-04**

**DOYEN**  
23,0 cm, 9"



leicht hohl  
slightly-concave  
légèrement concave  
ligeremente concavos  
незначительно вогнутое

**Fig. a x b**

- 1 55 x 35 mm **23-57-260-01**
- 2 85 x 35 mm **23-57-260-02**
- 3 115 x 35 mm **23-57-260-03**

- 1 55 x 45 m-m **23-57-261-01**
- 2 85 x 45 mm **23-57-261-02**
- 3 115 x 45 mm **23-57-261-03**

- 1 55 x 60 mm **23-57-262-01**
- 2 85 x 60 mm **23-57-262-02**
- 3 115 x 60 mm **23-57-262-03**

**DOYEN**  
23,0 cm, 9"

Vaginalspekula  
 Vaginal Specula  
 Speculums vaginaux  
 Espécules vaginales  
 Зеркала гинекологические



halb-hohl  
 slightly-concave  
 demi concave  
 semi-concavos  
 средне-вогнутое

Fig. a x b

- |   |             |                     |
|---|-------------|---------------------|
| 1 | 60 x 35 mm  | <b>23-57-264-01</b> |
| 2 | 90 x 35 mm  | <b>23-57-264-02</b> |
| 3 | 120 x 35 mm | <b>23-57-264-03</b> |
| 4 | 130 x 35 mm | <b>23-57-264-04</b> |
|   |             |                     |
| 1 | 60 x 45 mm  | <b>23-57-265-01</b> |
| 2 | 90 x 45 mm  | <b>23-57-265-02</b> |
| 3 | 120 x 45 mm | <b>23-57-265-03</b> |
| 4 | 130 x 45 mm | <b>23-57-265-04</b> |
|   |             |                     |
| 1 | 60 x 60 mm  | <b>23-57-266-01</b> |
| 2 | 90 x 60 mm  | <b>23-57-266-02</b> |
| 3 | 120 x 60 mm | <b>23-57-266-03</b> |
| 4 | 130 x 60 mm | <b>23-57-266-04</b> |

**DOYEN**  
 23,0 cm, 9"

a x b



**BREISKY**

- |             |                     |
|-------------|---------------------|
| 70 x 25 mm  | <b>23-57-302-25</b> |
| 100 x 20 mm | <b>23-57-307-20</b> |
| 100 x 25 mm | <b>23-57-307-25</b> |
| 100 x 30 mm | <b>23-57-307-30</b> |
| 100 x 35 mm | <b>23-57-307-35</b> |
| 100 x 40 mm | <b>23-57-307-40</b> |
|             |                     |
| 120 x 20 mm | <b>23-57-317-20</b> |
| 120 x 25 mm | <b>23-57-317-25</b> |
| 120 x 30 mm | <b>23-57-317-30</b> |
| 120 x 35 mm | <b>23-57-317-35</b> |
| 120 x 40 mm | <b>23-57-317-40</b> |
|             |                     |
| 130 x 20 mm | <b>23-57-308-20</b> |
| 130 x 25 mm | <b>23-57-308-25</b> |
| 130 x 30 mm | <b>23-57-308-30</b> |
| 130 x 35 mm | <b>23-57-308-35</b> |
| 130 x 40 mm | <b>23-57-308-40</b> |
|             |                     |
| 155 x 40 mm | <b>23-57-309-40</b> |
|             |                     |
| 160 x 20 mm | <b>23-57-303-20</b> |
| 160 x 25 mm | <b>23-57-303-25</b> |
| 160 x 30 mm | <b>23-57-303-30</b> |
| 160 x 35 mm | <b>23-57-303-35</b> |
| 160 x 40 mm | <b>23-57-303-40</b> |
|             |                     |
| 180 x 20 mm | <b>23-57-304-20</b> |
| 180 x 25 mm | <b>23-57-304-25</b> |
| 180 x 30 mm | <b>23-57-304-30</b> |
| 180 x 35 mm | <b>23-57-304-35</b> |
| 180 x 40 mm | <b>23-57-304-40</b> |



Satz  
Set  
Jeu  
Juego  
Набор

**KALLMORGEN**  
70 x 40 mm **23-57-270-01**  
90 x 40 mm **23-57-270-02**



Spekula allein  
Specula only  
Speculums seul  
Espécules suelto  
только зеркало

**KALLMORGEN**  
70 x 40 mm **23-57-271-01**  
90 x 40 mm **23-57-271-02**



Halter allein  
Retractors only  
Valvas vaginae seul  
Valvas suelto  
только ретрактор

**KALLMORGEN**  
70 x 33 mm **23-57-272-01**  
90 x 33 mm **23-57-272-02**



70 x 15 mm

**KRISTELLER**  
17,0 cm, 6<sup>3</sup>/<sub>4</sub>"  
**23-57-275-17**



**JACKSON**  
175 x 38 mm **23-57-290-01**  
190 x 38 mm **23-57-290-02**  
100 x 38 mm **23-57-290-03**

Vaginalspekula  
Vaginal Specula  
Speculums vaginaux  
Espécules vaginales  
Зеркала гинекологические



**BREISKY**  
14,0 cm, 5½"  
23-57-292-01



**BREISKY**  
14,0 cm, 5½"  
23-57-292-02



**BREISKY**  
17,0 cm, 6¾"  
23-57-292-03

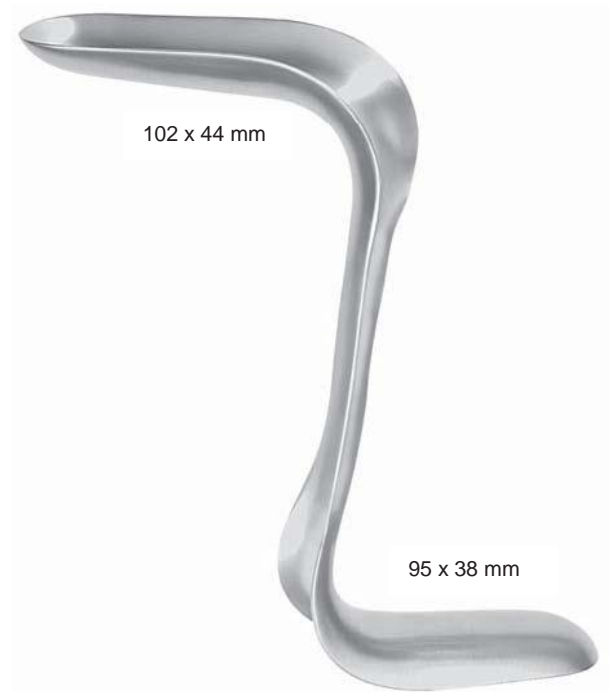

**BREISKY**  
17,0 cm, 6¾"  
23-57-292-04





Vaginalspekula und Scheidenhalter  
Vaginal Specula and Retractors  
Speculums vaginaux, Valves vaginales  
Espéculos y valvas vaginales  
Зеркала гинекологические и держатели

**SIMS**  
23-57-294-00  
Satz, Set, Jeu,  
Juego, набор



**SIMS**  
12,5 cm, 5"  
23-57-294-01

**SIMS**  
15,0 cm, 6"  
23-57-294-02

**SIMS**  
17,5 cm, 7"  
23-57-294-03



**MATHIEU**  
100 x 13-23 mm 23-57-300-01  
100 x 16-30 mm 23-57-300-02

**MATHIEU**  
100 x 11-21 mm 23-57-301-01  
100 x 14-27 mm 23-57-301-02

**LANDAU**  
100 x 28 mm 23-57-305-01  
100 x 30 mm 23-57-305-02



Vaginalspekula  
 Vaginal Specula  
 Speculums vaginaux  
 Espécules vaginales  
 Зеркала гинекологические



85 x 17 mm

**BRAUN, MODIF.**  
 19,0 cm, 7½"  
 23-57-313-19

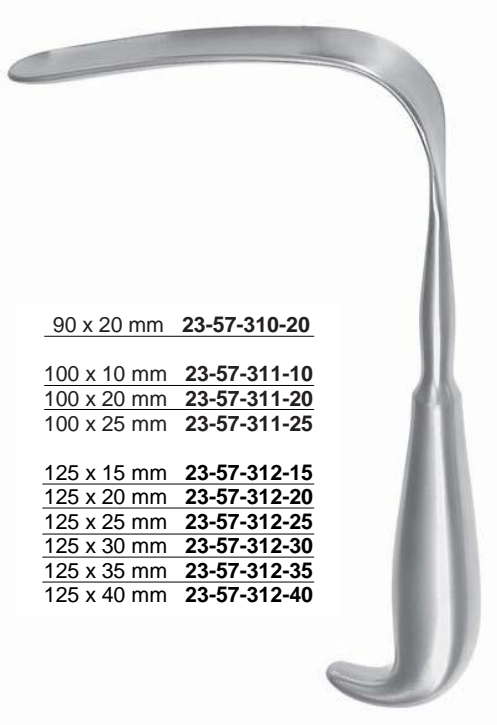

- 90 x 20 mm **23-57-310-20**
- 100 x 10 mm **23-57-311-10**
- 100 x 20 mm **23-57-311-20**
- 100 x 25 mm **23-57-311-25**
- 125 x 15 mm **23-57-312-15**
- 125 x 20 mm **23-57-312-20**
- 125 x 25 mm **23-57-312-25**
- 125 x 30 mm **23-57-312-30**
- 125 x 35 mm **23-57-312-35**
- 125 x 40 mm **23-57-312-40**

**MATZENAUER**



60 x 30 mm

**DOYEN**  
 23,0 cm, 9"  
 23-57-315-23



70 x 38 mm

**DOYEN**  
 24,0 cm, 9½"  
 23-57-315-24



80 x 30 mm

**DOYEN**  
 25,0 cm, 10"  
 23-57-315-25



95 x 38 mm

**WERTHEIM**  
 30,0 cm, 12"  
 23-57-318-30



Endospekula,  
Endospecula  
Endospeculums  
Endoespéculos  
Эндо-зеркала



Lateral-Spekulum, Intrauterinsonde  
Lateral Speculum, Intrauterine Probe  
Latéral Speculum, Intra-utérine bougie  
Espécule lateral, Sonda intra-uterina  
Боковые зеркала, внутриматочный зонд



Lateral-Spekulum  
Lateral speculum  
Latéral Speculum  
Espécule lateral  
Боковое зеркало

25,0 cm, 10"  
23-57-096-25



COHEN  
23-57-530-00

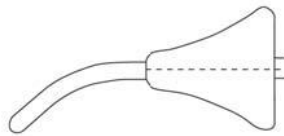

COHEN  
23-57-530-01

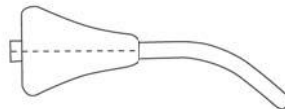

COHEN  
23-57-530-02



Uterus-Dilatatoren  
Uterine Dilators  
Dilatateurs du col de l'utérus  
Dilatadores uterinos  
Расширители шейки матки



**HEGAR**  
18,5 cm, 7¼"

- Ø 1,0 mm **23-57-350-01**
- Ø 2,0 mm **23-57-350-02**
- Ø 3,0 mm **23-57-350-03**
- Ø 4,0 mm **23-57-350-04**
- Ø 5,0 mm **23-57-350-05**
- Ø 6,0 mm **23-57-350-06**
- Ø 7,0 mm **23-57-350-07**
- Ø 8,0 mm **23-57-350-08**
- Ø 9,0 mm **23-57-350-09**
- Ø 10,0 mm **23-57-350-10**
- Ø 11,0 mm **23-57-350-11**
- Ø 12,0 mm **23-57-350-12**
- Ø 13,0 mm **23-57-350-13**
- Ø 14,0 mm **23-57-350-14**
- Ø 15,0 mm **23-57-350-15**
- Ø 16,0 mm **23-57-350-16**
- Ø 17,0 mm **23-57-350-17**
- Ø 18,0 mm **23-57-350-18**
- Ø 19,0 mm **23-57-350-19**
- Ø 20,0 mm **23-57-350-20**
- Ø 21,0 mm **23-57-350-21**
- Ø 22,0 mm **23-57-350-22**
- Ø 23,0 mm **23-57-350-23**
- Ø 24,0 mm **23-57-350-24**
- Ø 25,0 mm **23-57-350-25**
- Ø 26,0 mm **23-57-350-26**
- Ø 27,0 mm **23-57-350-27**
- Ø 28,0 mm **23-57-350-28**
- Ø 29,0 mm **23-57-350-29**
- Ø 30,0 mm **23-57-350-30**
- Ø 32,0 mm **23-57-350-32**



**HEGAR**  
18,5 cm, 7¼"

- Ø 1,5 mm **23-57-351-01**
- Ø 2,5 mm **23-57-351-02**
- Ø 3,5 mm **23-57-351-03**
- Ø 4,5 mm **23-57-351-04**
- Ø 5,5 mm **23-57-351-05**
- Ø 6,5 mm **23-57-351-06**
- Ø 7,5 mm **23-57-351-07**
- Ø 8,5 mm **23-57-351-08**
- Ø 9,5 mm **23-57-351-09**
- Ø 10,5 mm **23-57-351-10**
- Ø 11,5 mm **23-57-351-11**
- Ø 12,5 mm **23-57-351-12**
- Ø 13,5 mm **23-57-351-13**
- Ø 14,5 mm **23-57-351-14**
- Ø 15,5 mm **23-57-351-15**
- Ø 16,5 mm **23-57-351-16**
- Ø 17,5 mm **23-57-351-17**
- Ø 18,5 mm **23-57-351-18**
- Ø 19,5 mm **23-57-351-19**
- Ø 20,5 mm **23-57-351-20**
- Ø 21,5 mm **23-57-351-21**
- Ø 22,5 mm **23-57-351-22**
- Ø 23,5 mm **23-57-351-23**



205 x 105 x 45 mm

**HEGAR**  
**23-57-350-98**  
Satz, Set, Jeu, Juego, набор  
Ø 4,0 - Ø 17,0  
(14 dilators)

**HEGAR**  
**23-57-350-99**  
Satz, Set, Jeu, Juego, набор  
Ø 1,0 - Ø 26,0  
(26 dilators)

**Uterus-Dilatatoren  
Uterine Dilators  
Dilatateurs du col de l'utérus  
Dilatadores uterinos  
Расширители шейки матки**



20,0 cm, 8"

Ø 1,0 / 2,0 mm	<b>23-57-354-01</b>
Ø 3,0 / 4,0 mm	<b>23-57-354-03</b>
Ø 5,0 / 6,0 mm	<b>23-57-354-05</b>
Ø 7,0 / 8,0 mm	<b>23-57-354-07</b>
Ø 9,0 / 10,0 mm	<b>23-57-354-09</b>
Ø 11,0 / 12,0 mm	<b>23-57-354-11</b>
Ø 13,0 / 14,0 mm	<b>23-57-354-13</b>
Ø 15,0 / 16,0 mm	<b>23-57-354-15</b>
Ø 17,0 / 18,0 mm	<b>23-57-354-17</b>
Ø 19,0 / 20,0 mm	<b>23-57-354-19</b>
Ø 21,0 / 22,0 mm	<b>23-57-354-21</b>
Ø 23,0 / 24,0 mm	<b>23-57-354-23</b>
Ø 25,0 / 26,0 mm	<b>23-57-354-25</b>

**HEGAR**

Satz, Set, Jeu, Juego, набор  
**23-57-354-98** Ø 3,0 / 4,0 - Ø 17,0 / 18,0 mm (8 dilators)  
**23-57-354-99** Ø 1,0 / 2,0 - Ø 25,0 / 26,0 mm (13 dilators)  
 Metalletui, Metal case, en boîte métal,  
 Estuche de metal, коробка металлическая



**HEGAR**

**23-57-354-97**

Satz, Set, Jeu, Juego, набор  
 3,0 / 4,0 - 17/18 mm (8 dilators)  
 Tasche / bag / poche / el bolso / сумка



Ø 4,5 / 5,0 mm	<b>23-57-360-05</b>
Ø 5,5 / 6,0 mm	<b>23-57-360-06</b>
Ø 6,5 / 7,0 mm	<b>23-57-360-07</b>
Ø 7,5 / 8,0 mm	<b>23-57-360-08</b>
Ø 8,5 / 9,0 mm	<b>23-57-360-09</b>
Ø 9,5 / 10,0 mm	<b>23-57-360-10</b>

**HANK**

**23-57-360-98**

Satz, Set, Jeu, Juego, набор  
 Ø 4,5 / 5,0 - Ø 9,5 / 10,0 mm (6 dilators)

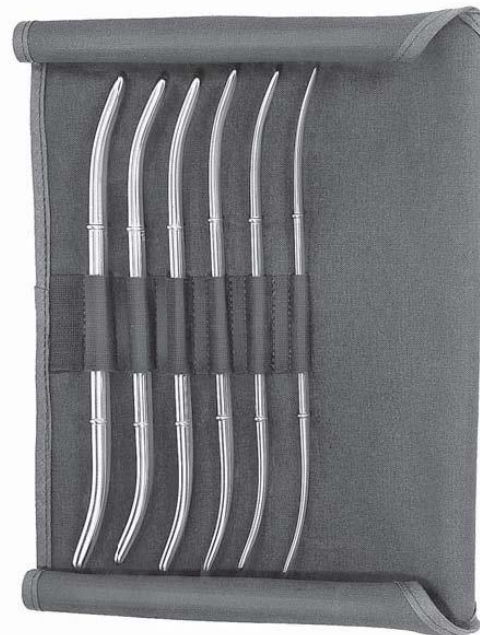

**HANK**

**23-57-360-99**

Satz, Set, Jeu, Juego, набор  
 Ø 4,5 / 5,0 - Ø 9,5 / 10,0 mm (6 dilators)  
 Tasche / bag / poche / el bolso / сумка

Uterus-Dilatatoren, Hakenzangen  
 Uterine Dilators, Uterine Tenaculum Forceps  
 Dilatateurs du col de l'utérus, Pince pour le col de l'utérus  
 Diladores uterinos, Pinzas para coger el cuello del útero  
 Расширители шейки матки, щипцы зубчатые маточные



- Ø 4,5 / 5,0 mm 23-57-370-05
- Ø 5,5 / 6,0 mm 23-57-370-06
- Ø 7,5 / 8,0 mm 23-57-370-08
- Ø 8,5 / 9,0 mm 23-57-370-09
- Ø 9,5 / 10,0 mm 23-57-370-10
- Ø 11,5 / 12,0 mm 23-57-370-12
- Ø 12,5 / 13,0 mm 23-57-370-13
- Ø 13,5 / 14,0 mm 23-57-370-14

**PRATT**  
 26,5 cm, 10 3/4"



**PRATT**  
 23-57-370-98

Satz, Set, Jeu, Juego, набор  
 Ø 4,5 / 5,0 - Ø 13,5 / 14,0 mm (8 dilators)



**BARRETT**  
 18,0 cm, 7"  
 23-57-410-18



**ADAIR**  
 19,0 cm, 7 1/2"  
 23-57-412-19



**STAUDE-MOORE**  
 17,0 cm, 6 3/4"  
 23-57-414-17



**Hakenzangen**  
**Uterine Tenaculum Forceps**  
**Pince pour le col de l'utérus**  
**Pinzas para coger el cuello del útero**  
**Щипцы зубчатые маточные**

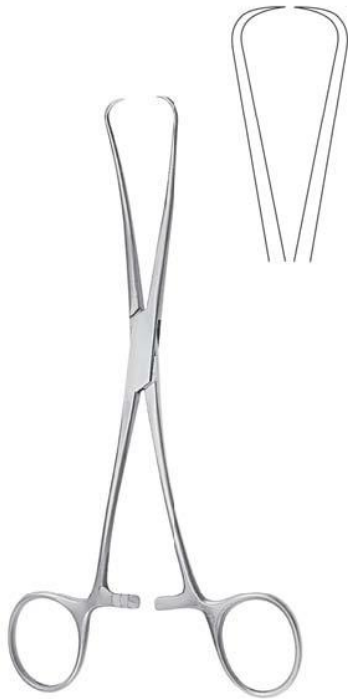

**JARCHO**  
 20,0 cm, 8"  
 23-57-417-20



**SCHROEDER**  
 25,0 cm, 9 3/4"  
 23-57-400-25



**BRAUN**  
 25,0 cm, 9 3/4"  
 23-57-404-25



**DUPLAY**  
 28,0 cm, 11"  
 23-57-419-28



**POZZI**  
 17,0 cm, 6 3/4" 23-57-402-17  
 25,0 cm, 10" 23-57-402-25



**KAHN**  
 22,0 cm, 8 3/4"  
 23-57-421-22

Hakenzangen  
 Uterine Tenaculum Forceps  
 Pince pour le col de l'utérus  
 Pinzas para coger el cuello del útero  
 Щипцы зубчатые маточные



**SKENE**  
 24,0 cm, 9½"  
 23-57-423-24



**SCHROEDER**  
 20,0 cm, 8" 23-57-426-20  
 24,0 cm, 9½" 23-57-426-24



gebogen, curved, arqué,  
 curva, изогнутые

20,0 cm, 8" 23-57-429-20  
 24,0 cm, 9½" 23-57-429-24

seitlich gebogen  
 curved to side  
 latéral arqué  
 en ellado porcido  
 на сторону изогнутые

24,0 cm, 9½" 23-57-430-24



**TEALE**  
 23,0 cm, 9"  
 23-57-431-23



**JACOBS**  
 21,0 cm, 8½"  
 23-57-434-21



**JACOBS**  
 21,0 cm, 8½"  
 23-57-435-21



**Hakenzangen**  
**Uterine Tenaculum Forceps**  
**Pince pour le col de l'utérus**  
**Pinzas para coger el cuello del útero**  
**Щипцы зубчатые маточные**



**MUSEUX**  
 24,0 cm, 9½"



6 mm  
 23-57-440-06



8 mm  
 23-57-440-08



10 mm  
 23-57-440-10



**MUSEUX**  
 24,0 cm, 9½"



6 mm  
 23-57-441-06



8 mm  
 23-57-441-08



10 mm  
 23-57-441-10



**BRAUN**  
 15,5 cm, 6"  
 23-57-442-15



**CZERNY**  
 20,5 cm, 8"  
 23-57-444-20



**PRATT**  
 28,0 cm, 11"  
 23-57-446-28



**IOWA**  
 26,0 cm, 10¼"  
 23-57-449-26

Polypen- und Ovarienzangen, Uterusfaßzangen  
 Polypus and Ovum Forceps, Uterine Elevating Forceps  
 Pincés a polypes utérins, Pincés hysterolabes  
 Pinzas para pólipos uterinos y ovarios, Pinzas para la útero  
 Зажимы полипные, зажимы для яичников, зажимы для матки



**DOYEN**  
 20,5 cm, 8"  
 23-57-470-20



**NOTO**  
 27,0 cm, 10<sup>5</sup>/<sub>8</sub>"  
 23-57-472-27



**KELLY**  
 32,0 cm, 12<sup>1</sup>/<sub>2</sub>"  
 23-57-475-32



**HEYWOOD-SMITH**  
 21,0 cm, 8<sup>3</sup>/<sub>4</sub>" 23-57-480-21  
 25,0 cm, 9<sup>3</sup>/<sub>4</sub>" 23-57-480-25



**DARTIGUES**  
 27,0 cm, 10<sup>3</sup>/<sub>4</sub>"  
 23-57-482-27



**SOMER**  
 23,0 cm, 9"  
 23-57-485-23

**Uterusfaßzangen, Uterussonden  
 Uterine Elevating Forceps, Uterine Probes,  
 Pincés hysterolabes, Hystéromètres  
 Histerolabos, Histerómetros  
 Зажимы для матки, зонды для матки**



**0°**  
 gerade  
 straight  
 droit  
 recta  
 прямые

**23-57-488-25**

**COLLIN**  
 25,0 cm, 9¾"



**45°**  
 gewinkelt  
 angled  
 angulaire  
 coudes  
 под углом

**23-57-489-25**

**BEACHAM**  
 26,0 cm, 10¼"  
**23-57-500-26**



Amniotom  
 Amniotome  
 Amniótome  
 Амниотом

Uterus-Depressor  
 Uterine depressor  
 Dépresseur utérin  
 Depresor uterino  
 Амниотом

**BRAUN**  
 28,0 cm, 11"  
**23-57-502-28**

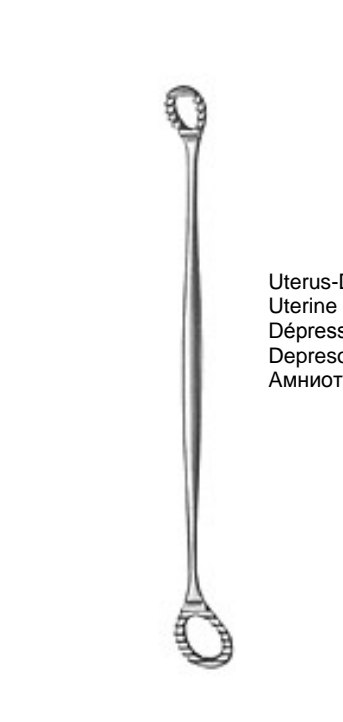

Uterus-Depressor  
 Uterine depressor  
 Dépresseur utérin  
 Depresor uterino  
 Амниотом

**SIMS**  
 26,0 cm, 10¼"  
**23-57-505-26**



**SIMS**  
 32,0 cm, 12½"  
**23-57-510-32**



biegsam  
 malleable  
 malléable  
 maleable  
 изгибаемый

**SIMS**  
 32,0 cm, 12½"  
**23-57-511-32**



**MARTIN**  
32,0 cm, 12½"  
23-57-516-32



biegsam  
malleable  
malléable  
maleable  
изгибаемый

**MARTIN**  
32,0 cm, 12½"  
23-57-518-32



biegsam  
malleable  
malléable  
maleable  
изгибаемый

**SIMPSON**  
29,0 cm, 11½" Ø 4 mm  
23-57-527-29



**VALLEIX**  
25,0 cm, 10"  
23-57-521-25



**COLLIN**  
28,0 cm, 11" Ø 4 mm  
23-57-529-28

**Biopsieküretten**  
**Biopsy Curettes**  
**Curettes pour calculs biopsie**  
**Curetas para biopsia**  
**Кюретки биопсийные**



**KEVORKIAN**  
 30,0 cm, 12"  
 23-57-540-30



**KEVORKIAN**  
 30,0 cm, 12"  
 23-57-542-30



1,2 mm **23-57-543-12**  
 4,0 mm **23-57-544-40**

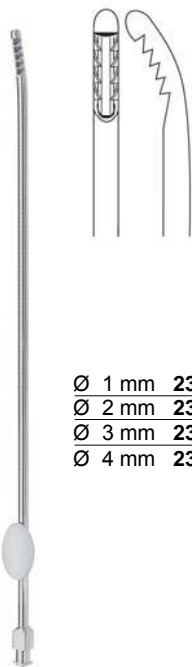

Ø 1 mm **23-57-550-01**  
 Ø 2 mm **23-57-550-02**  
 Ø 3 mm **23-57-550-03**  
 Ø 4 mm **23-57-550-04**

**NOVAK**  
 23,0 cm, 9" Ø 4 mm

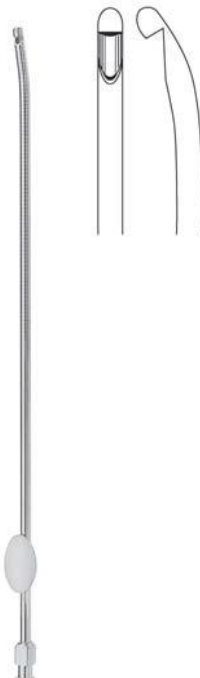

**RANDALL**  
 23,0 cm, 9" Ø 4 mm  
 23-57-552-04



**MILAN**  
 28,0 cm, 11"



Ø 4 mm  
**23-57-560-04**



Ø 6 mm  
**23-57-560-06**



Ø 9 mm  
**23-57-560-09**



Myominstrumente  
Myoma Instruments  
Tracteurs pour fibromes, Evideur de fibromes  
Instrumentos para mioma  
Инструменты для миомы



25,0 cm, 9<sup>3</sup>/<sub>4</sub>"  
23-57-570-25



17,0 cm, 6<sup>3</sup>/<sub>4</sub>"  
23-57-572-17



**SIMON**  
22,0 cm, 8<sup>5</sup>/<sub>8</sub>"  
23-57-574-22



**EMMETT**  
22,0 cm, 8<sup>5</sup>/<sub>8</sub>"



23-57-576-01



23-57-576-02



23-57-576-03



23-57-576-04



23-57-576-05



**SEGOND**  
27,0 cm, 10<sup>5</sup>/<sub>8</sub>"  
23-57-580-27



**AYRE**  
23,0 cm, 9"  
23-57-583-23

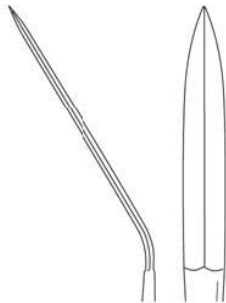

**DOYEN**  
17,0 cm, 6<sup>3</sup>/<sub>4</sub>"  
23-57-588-01



**DOYEN**  
17,0 cm, 6<sup>3</sup>/<sub>4</sub>"  
23-57-588-02

**Uterusküretten  
Uterine Curettes  
Curettes utérines  
Curetas uterinas  
Кюретки маточные**

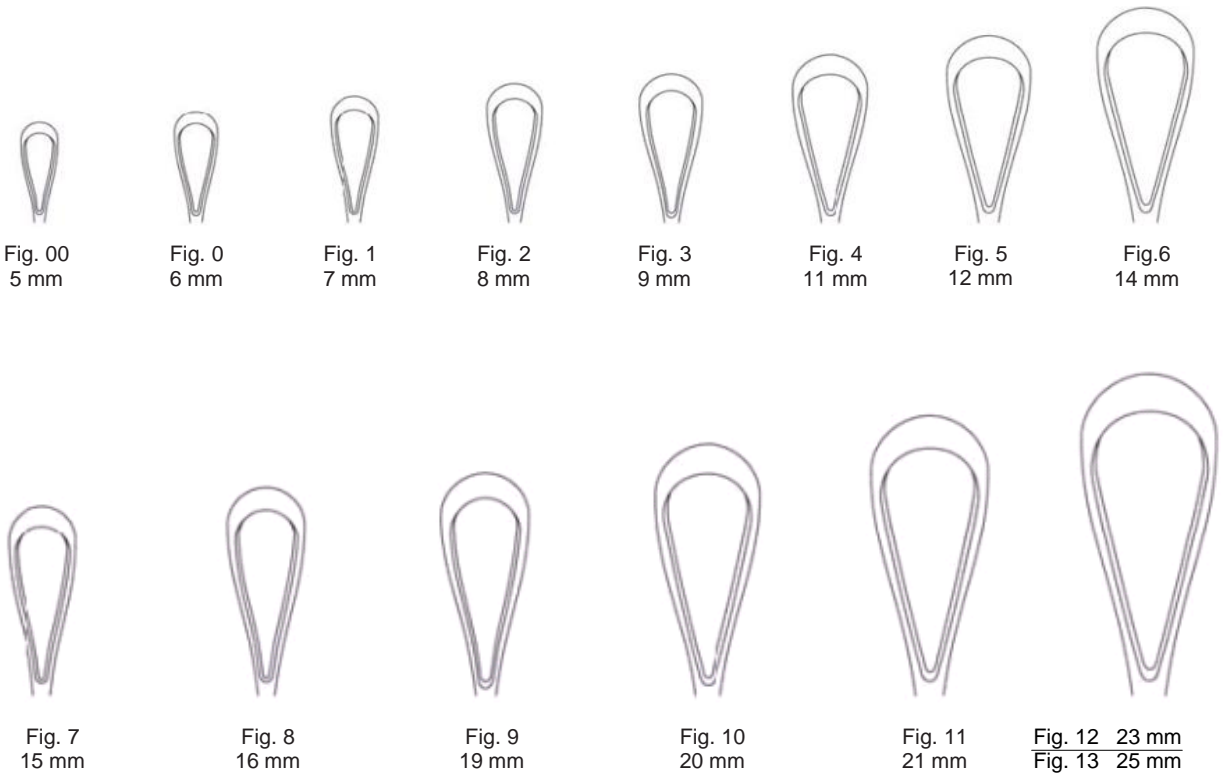

**RECAMIER**  
31,0 cm, 12¼"

stumpf, starr  
blunt, rigid  
mousse, rigide  
romo, rígidas  
тупые, жёсткие

- Fig. 00 23-57-700-05
- Fig. 0 23-57-700-06
- Fig. 1 23-57-700-07
- Fig. 2 23-57-700-08
- Fig. 3 23-57-700-09
- Fig. 4 23-57-700-11
- Fig. 5 23-57-700-12
- Fig. 6 23-57-700-14
- Fig. 7 23-57-700-15
- Fig. 8 23-57-700-16
- Fig. 9 23-57-700-19
- Fig. 10 23-57-700-20
- Fig. 11 23-57-700-21
- Fig. 12 23-57-700-23
- Fig. 13 23-57-700-25



**RECAMIER**  
31,0 cm, 12¼"

stumpf, biegsam  
blunt, malleable  
mousse, malléable  
romo, maleable  
тупые, изгибаемые

- Fig. 00 23-57-701-05
- Fig. 0 23-57-701-06
- Fig. 1 23-57-701-07
- Fig. 2 23-57-701-08
- Fig. 3 23-57-701-09
- Fig. 4 23-57-701-11
- Fig. 5 23-57-701-12
- Fig. 6 23-57-701-14
- Fig. 7 23-57-701-15
- Fig. 8 23-57-701-16
- Fig. 9 23-57-701-19
- Fig. 10 23-57-701-20
- Fig. 11 23-57-701-21
- Fig. 12 23-57-701-23
- Fig. 13 23-57-701-25

Uterusküretten  
 Uterine Curettes  
 Curettes utérines  
 Curetas uterinas  
 Кюретки маточные

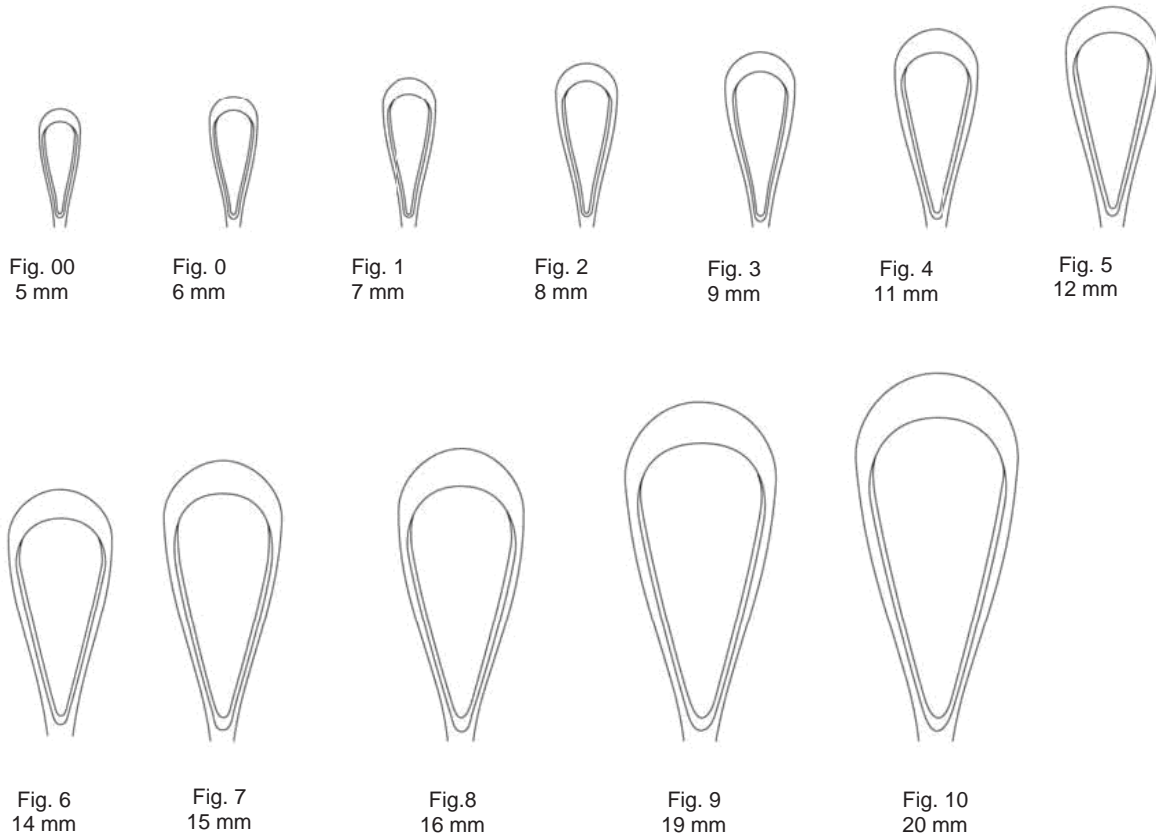

stumpf, starr  
 blunt, rigid  
 mousse, rigide  
 romo, rígidas  
 тупые, жёсткие

- Fig. 00 23-57-702-05
- Fig. 0 23-57-702-06
- Fig. 1 23-57-702-07
- Fig. 2 23-57-702-08
- Fig. 3 23-57-702-09
- Fig. 4 23-57-702-11
- Fig. 5 23-57-702-12
- Fig. 6 23-57-702-14
- Fig. 7 23-57-702-15
- Fig. 8 23-57-702-16
- Fig. 9 23-57-702-19
- Fig. 10 23-57-702-20

**SIMS**  
 28,0 cm, 11"



stumpf, biegsam  
 blunt, malleable  
 mousse, malléable  
 romo, maleable  
 тупые, изгибаемые

- Fig. 00 23-57-703-05
- Fig. 0 23-57-703-06
- Fig. 1 23-57-703-07
- Fig. 2 23-57-703-08
- Fig. 3 23-57-703-09
- Fig. 4 23-57-703-11
- Fig. 5 23-57-703-12
- Fig. 6 23-57-703-14
- Fig. 7 23-57-703-15
- Fig. 8 23-57-703-16
- Fig. 9 23-57-703-19
- Fig. 10 23-57-703-20

**SIMS**  
 28,0 cm, 11"



**Uterusküretten  
Uterine Curettes  
Curettes utérines  
Curetas uterinas  
Кюретки маточные**



Fig. 00  
5 mm

Fig. 0  
6 mm

Fig. 1  
7 mm

Fig. 2  
8 mm

Fig. 3  
9 mm

Fig. 4  
11 mm

Fig. 5  
12 mm

Fig. 6  
14 mm

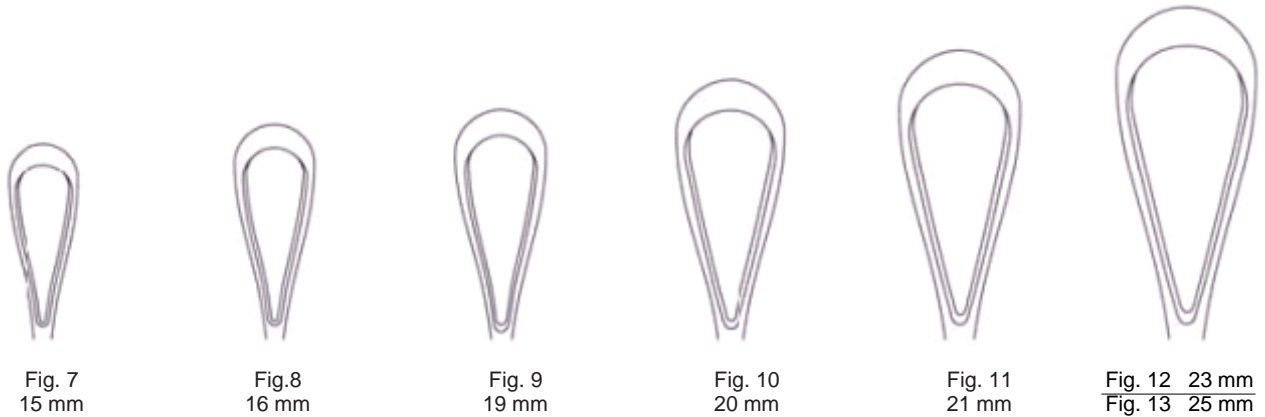

Fig. 7  
15 mm

Fig. 8  
16 mm

Fig. 9  
19 mm

Fig. 10  
20 mm

Fig. 11  
21 mm

Fig. 12 23 mm  
Fig. 13 25 mm



scharf, fest  
sharp, rigid  
tranchante, rigide  
cortantes, rígidas  
острые, жёсткие

- Fig. 00 **23-57-710-05**
- Fig. 0 **23-57-710-06**
- Fig. 1 **23-57-710-07**
- Fig. 2 **23-57-710-08**
- Fig. 3 **23-57-710-09**
- Fig. 4 **23-57-710-11**
- Fig. 5 **23-57-710-12**
- Fig. 6 **23-57-710-14**
- Fig. 7 **23-57-710-15**
- Fig. 8 **23-57-710-16**
- Fig. 9 **23-57-710-19**
- Fig. 10 **23-57-710-20**
- Fig. 11 **23-57-710-21**
- Fig. 12 **23-57-710-23**
- Fig. 13 **23-57-710-25**

**RECAMIER**  
31,0 cm, 12¼"



scharf, biegsam  
sharp, malleable  
tranchante, malléable  
cortantes, maleable  
острые, изгибаемые

- Fig. 00 **23-57-711-05**
- Fig. 0 **23-57-711-06**
- Fig. 1 **23-57-711-07**
- Fig. 2 **23-57-711-08**
- Fig. 3 **23-57-711-09**
- Fig. 4 **23-57-711-11**
- Fig. 5 **23-57-711-12**
- Fig. 6 **23-57-711-14**
- Fig. 7 **23-57-711-15**
- Fig. 8 **23-57-711-16**
- Fig. 9 **23-57-711-19**
- Fig. 10 **23-57-711-20**
- Fig. 11 **23-57-711-21**
- Fig. 12 **23-57-711-23**
- Fig. 13 **23-57-711-25**

**RECAMIER**  
31,0 cm, 12¼"



Fig. 00  
5 mm

Fig. 0  
6 mm

Fig. 1  
7 mm

Fig. 2  
8 mm

Fig. 3  
9 mm

Fig. 4  
11 mm

Fig. 5  
12 mm

Fig. 6  
14 mm



scharf, fest  
 sharp, rigid  
 tranchante, rigide  
 cortantes, rígidas  
 острые, жёсткие

- Fig. 00 23-57-712-05
- Fig. 0 23-57-712-06
- Fig. 1 23-57-712-07
- Fig. 2 23-57-712-08
- Fig. 3 23-57-712-09
- Fig. 4 23-57-712-11
- Fig. 5 23-57-712-12
- Fig. 6 23-57-712-14

**SIMS**  
28,0 cm, 11"



scharf, biegsam  
 sharp, malleable  
 tranchante, malléable  
 cortantes, maleable  
 острые, изгибаемые

- Fig. 00 23-57-713-05
- Fig. 0 23-57-713-06
- Fig. 1 23-57-713-07
- Fig. 2 23-57-713-08
- Fig. 3 23-57-713-09
- Fig. 4 23-57-713-11
- Fig. 5 23-57-713-12
- Fig. 6 23-57-713-14

**SIMS**  
28,0 cm, 11"

Uterusküretten  
 Curettes utérines  
 Uterine Curettes  
 Curetas uterinas  
 Кюретки маточные

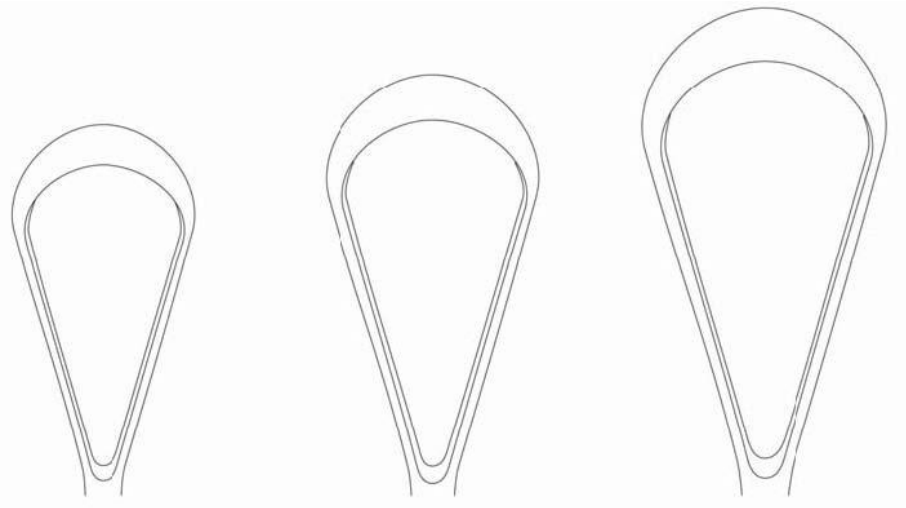

Fig. 1  
30 mm

Fig. 2  
35 mm

Fig.3  
40 mm



scharf, fest  
 sharp, rigid  
 tranchante, rigide  
 cortantes, rígidas  
 острые, жёсткие

Fig. 1 **23-57-720-30**  
 Fig. 2 **23-57-720-35**  
 Fig. 3 **23-57-720-40**

BUMM



scharf, biegsam  
 sharp, malleable  
 tranchante, malléable  
 cortantes, maleable  
 острые, изгибаемые

Fig. 1 **23-57-721-30**  
 Fig. 2 **23-57-721-35**  
 Fig. 3 **23-57-721-40**

BUMM

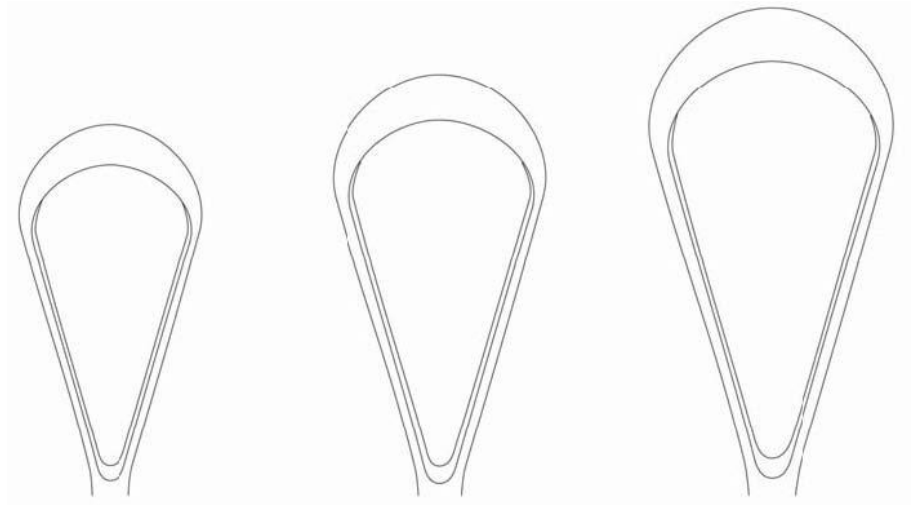

Fig. 1  
30 mm

Fig. 2  
35 mm

Fig.3  
40 mm



stumpf, fest  
 blunt, rigid  
 mousse, rigide  
 cortantes, rígidas  
 тупые, жёсткие

Fig. 1 23-57-722-30  
 Fig. 2 23-57-722-35  
 Fig. 3 23-57-722-40

BUMM



stumpf, biegsam  
 blunt, malleable  
 mousse, malléable  
 cortantes, maleable  
 тупые, изгибаемые

Fig. 1 23-57-723-30  
 Fig. 2 23-57-723-35  
 Fig. 3 23-57-723-40

BUMM

**Uteruslöffel, Uterus-Biopsiezangen**  
**Uterine Scoopes, Cervical Biopsy and Specimen Forceps**  
**Curettes utérines, Pinces pour biopsie**  
**Cucharillas uterinas, Pinzas saca-bocados para biopsia**  
**Ложки маточные, зажимы для взятия биопсии**



**BLAKE**  
 27,0 cm, 10<sup>5</sup>/<sub>8</sub>"  
 23-57-750-27



**SIMON**  
 25,0 cm, 9<sup>3</sup>/<sub>4</sub>"

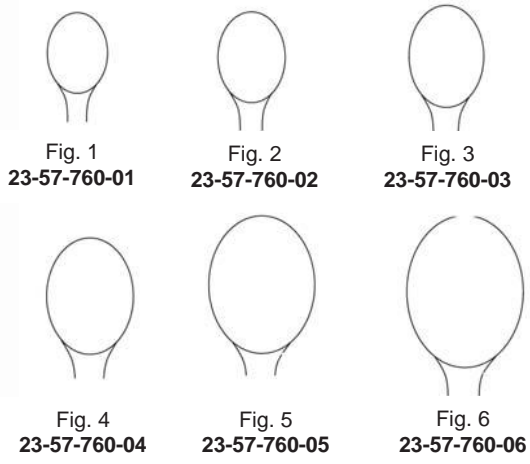

Fig. 1  
23-57-760-01

Fig. 2  
23-57-760-02

Fig. 3  
23-57-760-03

Fig. 4  
23-57-760-04

Fig. 5  
23-57-760-05

Fig. 6  
23-57-760-06



22,0 cm, 8<sup>5</sup>/<sub>8</sub>" 23-57-680-22  
 24,0 cm, 9<sup>1</sup>/<sub>2</sub>" 23-57-680-24

**THOMS-GAYLOR**



5 mm

**SCHUMACHER-VAN DOREN**  
 24,0 cm, 9<sup>1</sup>/<sub>2</sub>"  
 23-57-684-24



4,5 x 8 mm

**FAURE**  
 21,0 cm, 8<sup>1</sup>/<sub>4</sub>"  
 23-57-688-21



Uterus-Biopsiezangen  
Cervical Biopsy and Specimen Forceps  
Pinzas para biopsia  
Зажимы для взятия биопсии



SCHUBERT

8 x 5 mm

21,0 cm, 8<sup>1</sup>/<sub>4</sub>" 23-57-682-21  
28,0 cm, 11<sup>1</sup>/<sub>2</sub>" 23-57-682-28



SCHUBERT  
26,0 cm, 10<sup>1</sup>/<sub>4</sub>"  
23-57-690-26

4,5 x 8 mm

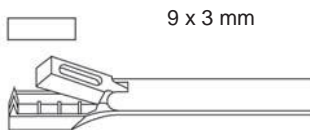

9 x 3 mm

KEVORKIAN  
25,0 cm, 10"  
23-57-602-25

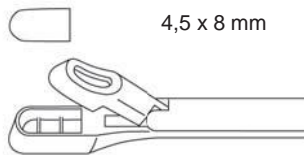

4,5 x 8 mm

EPPENDORFER  
20,0 cm, 8"  
23-57-604-20

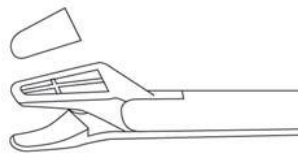

ALEXANDER  
28,0 cm, 11"  
23-57-608-28

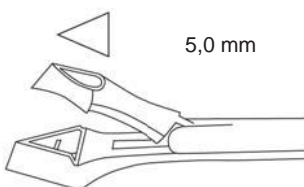

5,0 mm

SCHUMACHER  
24,0 cm, 9<sup>1</sup>/<sub>2</sub>"  
23-57-610-04

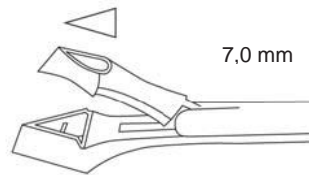

7,0 mm

SCHUMACHER  
24,0 cm, 9<sup>1</sup>/<sub>2</sub>"  
23-57-610-06

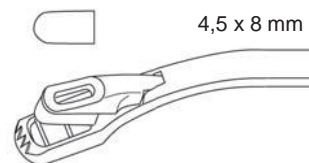

4,5 x 8 mm

WITTNER  
23,0 cm, 9"  
23-57-615-23

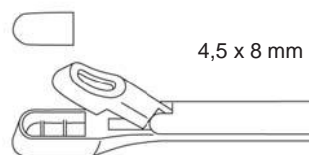

4,5 x 8 mm

WITTNER  
23,0 cm, 9"  
23-57-614-23

Uterus-Biopsiezangen  
 Cervical Biopsy and Specimen Forceps  
 Pinces pour biopsie  
 Pinzas saca-bocados para biopsia  
 Зажимы для взятия биопсии

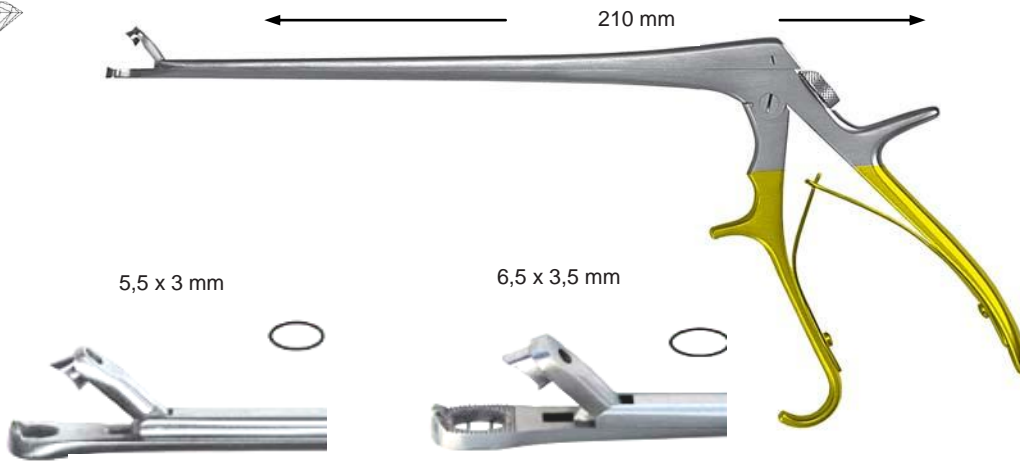

**BAGGISH**  
23-57-630-50

**BURKE**  
23-57-630-51

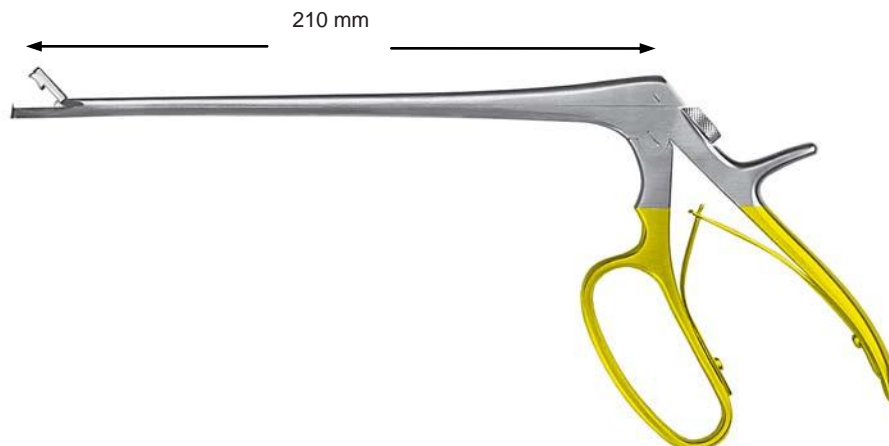

7 x 3 mm



**TISCHLER-MORGAN**  
23-57-630-10

7,5 x 3 mm



**COPPELSON**  
23-57-630-42

2,3 x 4 mm



**MINI-TOWNSEND**  
23-57-630-12

9 x 3 mm



**TISCHLER-KEVORKIAN**  
23-57-630-41

2,3 x 4 mm



**BABY-TISCHLER**  
23-57-630-14

9 x 3 mm



**KEVORKIAN-PACIFIC**  
23-57-630-40



**WRIGLEY**  
28,0 cm, 11"  
23-58-056-28



**SIMPSON**  
23,0 cm, 9<sup>3</sup>/<sub>4</sub>" 23-58-034-23  
30,0 cm, 11<sup>3</sup>/<sub>4</sub>" 23-58-034-30



**SIMPSON-BRAUN**  
33,0 cm, 13" 23-58-036-33  
36,0 cm, 14<sup>1</sup>/<sub>8</sub>" 23-58-036-36



**SIMPSON-LUIKART**  
36,0 cm, 14<sup>1</sup>/<sub>8</sub>"  
23-58-046-36



**DE LEE**  
30,0 cm, 11<sup>3</sup>/<sub>4</sub>"  
23-58-058-30



**DE LEE**  
36,0 cm, 14<sup>1</sup>/<sub>8</sub>"  
23-58-058-36



**DE LEE**  
39,0 cm, 15<sup>3</sup>/<sub>8</sub>"  
23-58-058-39



Geburtszangen  
Obstetrical Forceps  
Forceps obstétriques  
Fórceps para obstétrica  
Акушерские зажимы



**MC LEAN**  
36,0 cm, 14 $\frac{1}{8}$ "  
23-58-044-36



**KIELAND**  
41,0 cm, 16"  
23-58-052-41



**KIELAND-LUIKART**  
40,0 cm, 15 $\frac{3}{4}$ "  
23-58-054-40



**ELLIOT**  
32,0 cm, 12 $\frac{1}{2}$ " 23-58-080-32  
38,0 cm, 15 $\frac{3}{8}$ " 23-58-080-38



**NAEGELE**  
36,0 cm, 14 $\frac{1}{8}$ " 23-58-084-36  
40,0 cm, 15 $\frac{3}{4}$ " 23-58-084-40



**PIPER**  
44,0 cm, 17 $\frac{1}{4}$ "  
23-58-060-44

Geburtszangen, Plazentar- und Abortuszangen  
 Obstetrical Forceps, Placenta and Ovum Forceps  
 Forceps obstétriques, Pincés placentaires et pour post-abortum  
 Fórceps para obstétrica, Pinzas para aborto y placenta  
 Акушерские зажимы, щипцы для плаценты и яйцеклетки



**GREEN-ARMYTAGE**  
 21,0 cm, 8¼"  
 23-58-200-21



**PESTALOZZA**  
 30,0 cm, 11¾"  
 23-58-252-30



**SAENGER**  
 27,0 cm, 10⅝"  
 23-58-260-27



**SAENGER**  
 27,0 cm, 10⅝"  
 23-58-261-27



**WINTER**  
 28,0 cm, 11"



Fig. 1  
 23-58-244-01



Fig. 2  
 23-58-244-02



Fig. 3  
 23-58-244-03



Fig. 1  
 23-58-245-01

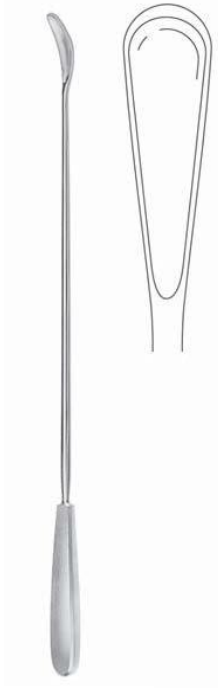

Fig. 2  
 23-58-245-02



Fig. 3  
 23-58-245-03

Plazentar- und Abortuszangen  
Placenta and Ovum Forceps  
Pinces placentaires et pour post-abortum  
Pinzas para aborto y placenta  
Щипцы для плаценты и яйцеклетки



**WALLICH**  
42,0 cm, 16½"  
23-58-300-42



**MARTIN**  
34,0 cm, 13¾"  
23-58-600-34



**SAENGER**  
27,0 cm, 10¾"  
23-58-236-01



**SAENGER**  
27,0 cm, 10¾"  
23-58-237-01



Leicht  
Medizintechnik

**Vorbereitung, Dermatologie**  
**Preparation, Dermatology**  
**Préparation, Dermatologie**  
**Preparación, Dermatología**  
**Препарирование, дерматология**







Hautstanzen, Nagel Instrumente  
Dermal Punches, Nail Instruments  
Poinçonnage cutané, Trépan cutané  
Trépanos cutáneos, Instrumentos para uñas  
Пробойники дерматологические, инструменты для ногтей



Lupusküretten  
Lupus curettes  
Curettes pour les lupus  
Curetas para lupus  
Lupus кюретка



3 mm  
25-59-110-03



4 mm  
25-59-110-04



5 mm  
25-59-110-05

**PIFFARD**  
14,0 cm, 5¾"



**KEYES**  
12,0 cm, 4¾"



2 mm  
25-59-200-02



3 mm  
25-59-200-03



4 mm  
25-59-200-04



5 mm  
25-59-200-05



6 mm  
25-59-200-06



7 mm  
25-59-200-07



8 mm  
25-59-200-08



9 mm  
25-59-200-09



**KEYES**  
12,0 cm, 4¾"  
25-59-210-00

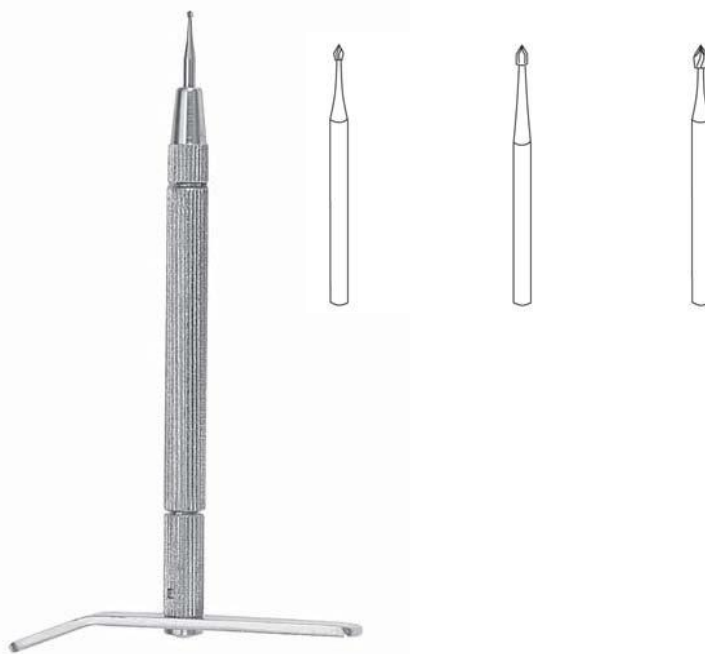

**25-59-400-00**  
komplett, complete, complet,  
completo, в наборе

Komedonenquetsche  
Comedo Extractors  
Tire-comédons  
Saca-comedones  
Экстрактор угрей



**UNNA**  
14,0 cm, 5<sup>3</sup>/<sub>4</sub>"  
25-59-000-14



**UNNA**  
14,0 cm, 5<sup>3</sup>/<sub>4</sub>"  
25-59-002-14



**SAALFELD**  
10,0 cm, 4"  
25-59-010-10



**SAALFELD**  
14,0 cm, 5<sup>3</sup>/<sub>4</sub>"  
25-59-012-14



**SCHAMBERG**  
10,0 cm, 4"  
25-59-020-10



**WALTON**  
14,0 cm, 5<sup>3</sup>/<sub>4</sub>"  
25-59-030-14



**FOX**  
14,0 cm, 5<sup>3</sup>/<sub>4</sub>"

Lupusküretten  
Lupus curettes  
Curettes pour les lupus  
Curetas para lupus  
Lupus кюретка



2 mm  
25-59-100-02



3 mm  
25-59-100-03



4 mm  
25-59-100-04



5 mm  
25-59-100-05

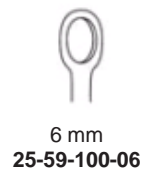

6 mm  
25-59-100-06



25-59-420-01

17,0 cm, 6¾"  
25-59-420-17



25-59-430-01

**WALTON**  
16,0 cm, 6¼"  
25-59-430-16



**RADOLF**  
13,5 cm, 5⅝"  
25-59-500-13



13,5 cm, 5⅝"  
25-59-510-13



13,0 cm, 5"  
25-59-600-13



25-59-610-01

25-59-610-02

14,0 cm, 5½"



**Knochenchirurgie**  
**Bone Surgery**  
**Chirurgia ossea**  
**Cirurgía ósea**  
**Костная хирургия**







Scharfe Löffel  
Bone Curettes  
Curettes tranchantes  
Cucharillas cortantes  
Костные кюретки

Fig. 000  
27-62-467-03

Fig. 00  
27-62-467-02

Fig. 0  
27-62-467-01

Fig. 1  
27-62-467-11

Fig. 2  
27-62-467-12

Fig. 3  
27-62-467-13

Fig. 4  
27-62-467-14

**SCHEDE**  
17,0 cm, 6¾"

Fig. 0000  
27-62-469-04

Fig. 000  
27-62-469-03

Fig. 00  
27-62-469-02

Fig. 0  
27-62-469-01

Fig. 1  
27-62-469-11

Fig. 2  
27-62-469-02

Fig. 3  
27-62-469-13

Fig. 4  
27-62-469-14

Fig. 5  
27-62-469-15

Fig. 6  
27-62-469-16

**VOLKMANN**  
17,0 cm, 6¾"

Fig. 0000  
27-62-472-04

Fig. 000  
27-62-472-03

Fig. 000  
27-62-472-02

Fig. 0  
27-62-472-01

Fig. 1  
27-62-472-11

Fig. 2  
27-62-472-12

Fig. 3  
27-62-472-13

Fig. 4  
27-62-472-14

Fig. 5  
27-62-472-15

Fig. 6  
27-62-472-16

**BRUNS**  
17,0 cm, 6¾"

Scharfe Löffel  
 Bone Curettes  
 Curettes tranchantes  
 Cucharillas cortantes  
 Костные кюретки

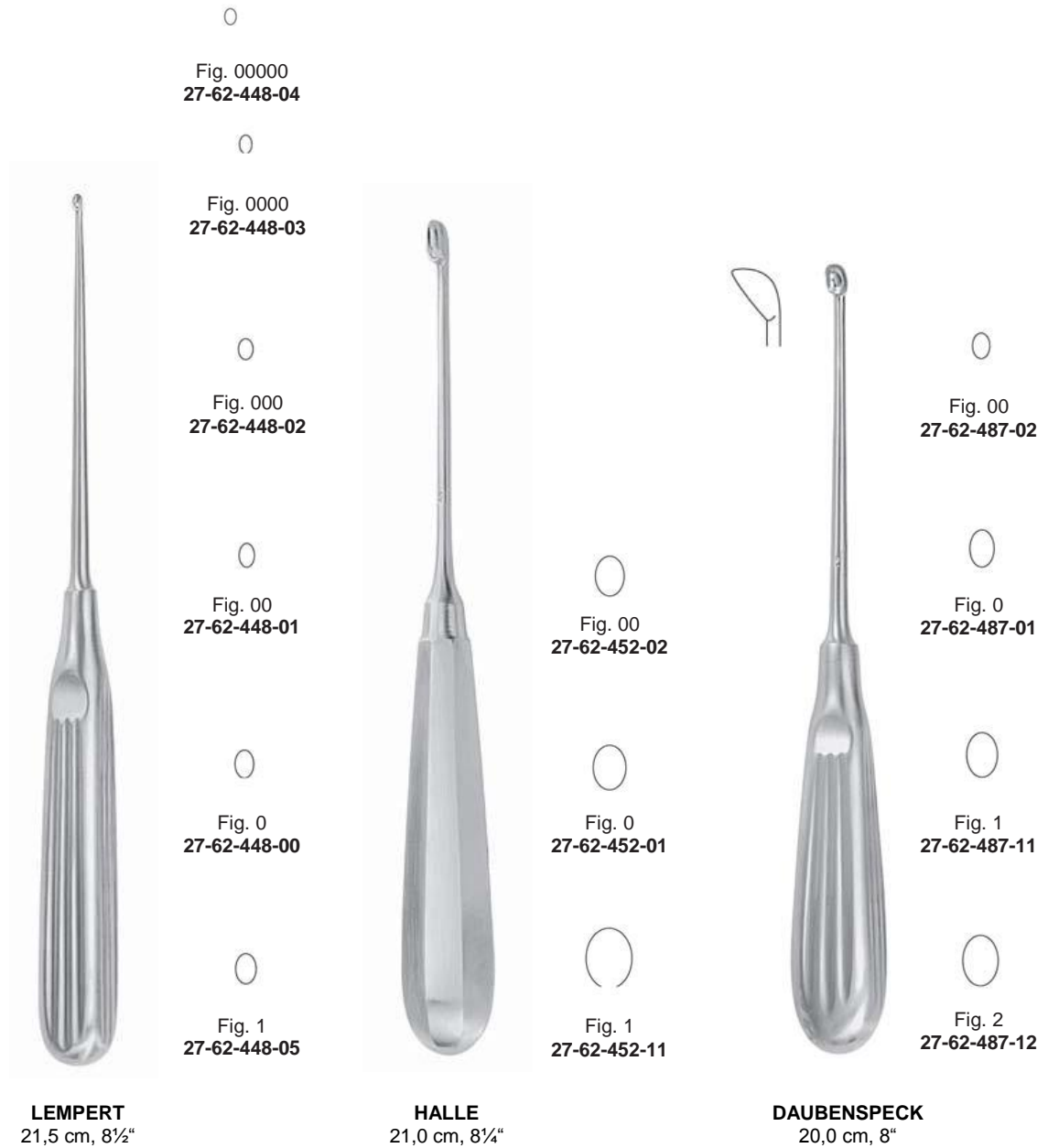

Scharfe Löffel  
Bone Curettes  
Curettes tranchantes  
Cucharillas cortantes  
Костные кюретки

**WILLIGER**  
17,0 cm, 6¾"

**WILLIGER**  
14,0 cm, 5½"

**MARTINI**  
14,0cm, 5½"

Fig. 00 27-62-430-00  
Fig. 0 27-62-430-00  
Fig. 1 27-62-430-11  
Fig. 2 27-62-430-12

Fig. 00 27-62-432-00  
Fig. 0 27-62-432-00  
Fig. 1 27-62-432-11  
Fig. 2 27-62-432-12

Fig. 0 27-62-406-00  
Fig. 1 27-62-406-01  
Fig. 2 27-62-406-02

Fig. 00/0 27-62-408-00 14,0 cm, 5½"  
Fig. 0/1 27-62-408-01 14,0 cm, 5½"  
Fig. 1/2 27-62-408-12 14,0 cm, 5½"

**VOLKMANN**

27-62-414-13 13,0 cm, 5"  
27-62-414-14 14,0 cm, 5½"  
27-62-414-17 17,0 cm, 6¾"  
27-62-414-20 20,0 cm, 8"

**JANSEN**  
15,0 cm, 6"  
27-62-411-15

**JANSEN**  
16,0 cm, 6¼"  
27-62-410-16

Dissektoren, Elevatorien  
 Dissectors, Elecators  
 Rugines, Elévateurs  
 Disecadores, Elevadores  
 Диссекторы, элеваторы

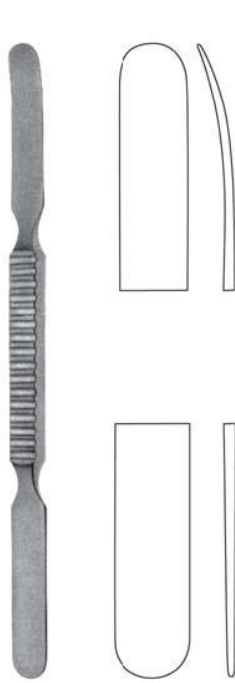

**WATSON-CHEYNE**  
 17,5 cm, 6¾"  
 27-63-501-17



**WILLIGER**  
 13,0 cm, 5"  
 27-63-512-13



**WILLIGER**  
 16,0 cm, 6½"  
 27-63-512-16



**WILLIGER**  
 17,0 cm, 6¾"  
 27-63-512-17

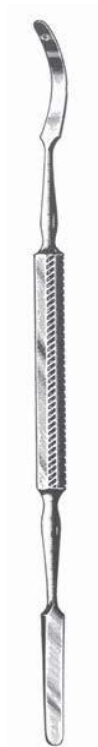

**MC DONALD**  
 19,0 cm, 7½"  
 27-63-440-19



**LANGENBECK**  
 20,0 cm, 8"  
 27-63-520-08



**LANGENBECK**  
 20,0 cm, 8"  
 27-63-520-10



8 mm  
27-63-465-01

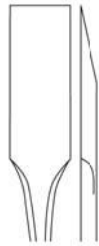

7 mm  
27-63-465-02



stumpf  
blunt  
mousse  
romo  
тупые

7 mm  
27-63-465-03



halbscharf  
half-sharp  
demi-pointu  
semi-agudos  
полуострые

7 mm  
27-63-465-04



scharf  
sharp  
pointu  
agudos  
острые



5 mm  
27-63-476-15

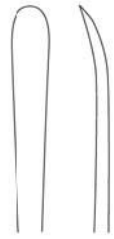

**ADSON**  
17,0 cm, 6¾"

**KÖNIG**  
15,5 cm, 6"



**LAMBOTTE**  
21,0 cm, 8¼"

5 mm  
27-63-477-05



10 mm  
27-63-477-10



15 mm  
27-63-477-15



20 mm  
27-63-077-20



25 mm  
27-63-477-25

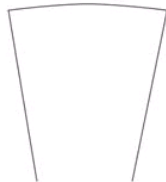

12,5 mm



**FARABEUF**  
15,0 cm, 6"  
27-63-478-15



12,5 mm



**FARABEUF**  
15,0 cm, 6"  
27-63-479-15



Raspatorien  
 Raspatories  
 Rugines-raspatoires, Rugines  
 Periostótomos  
 Распаторы



**LANGENBECK**  
 19,0 cm, 7½"  
 27-63-472-19



**SEDILLOT**  
 21,0 cm, 8¼"  
 27-63-488-21

16 mm

15 mm



**WILLIGER**  
 16,0 cm, 6¼"

4 mm	<b>27-63-480-04</b>
6 mm	<b>27-63-480-06</b>
8 mm	<b>27-63-480-08</b>



für Kinder  
 for children  
 pour enfants  
 para niños  
 для детей

**DOYEN**  
 17,0 cm, 6¾"  
 27-63-485-17



**DOYEN**  
 17,0 cm, 6¾"  
 27-63-487-17



für Erwachsene  
 for adults  
 pour adultes  
 para adultos  
 для взрослых

**DOYEN**  
 17,0 cm, 6¾" **27-63-481-17**  
 24,0 cm, 9½" **27-63-481-24**



**DOYEN**  
 17,0 cm, 6¾" **27-63-483-17**  
 24,0 cm, 9½" **27-63-483-24**





Flachmeißel, Hohlmeißel, Osteotome  
Chisels, Gouges, Osteotomes  
Ciseaux-burins, Gouges, Ostéotomes  
Cinceles, Gubias, Osteótomos  
Долота для костей, остеотомы

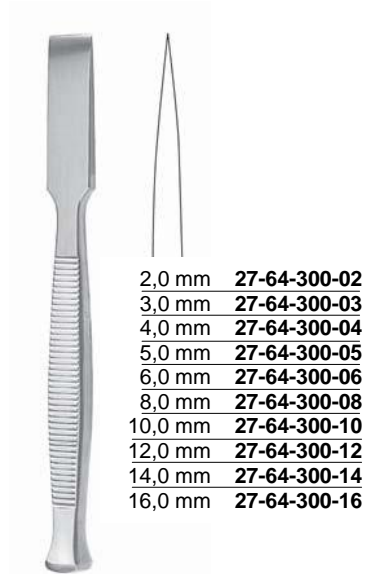

- 2,0 mm 27-64-300-02
- 3,0 mm 27-64-300-03
- 4,0 mm 27-64-300-04
- 5,0 mm 27-64-300-05
- 6,0 mm 27-64-300-06
- 8,0 mm 27-64-300-08
- 10,0 mm 27-64-300-10
- 12,0 mm 27-64-300-12
- 14,0 mm 27-64-300-14
- 16,0 mm 27-64-300-16

13,5 cm, 5 3/8"

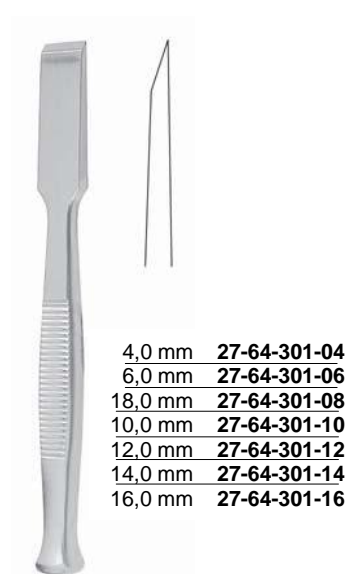

- 4,0 mm 27-64-301-04
- 6,0 mm 27-64-301-06
- 8,0 mm 27-64-301-08
- 10,0 mm 27-64-301-10
- 12,0 mm 27-64-301-12
- 14,0 mm 27-64-301-14
- 16,0 mm 27-64-301-16

13,5 cm, 5 3/8"



- 4,0 mm 27-64-302-04
- 6,0 mm 27-64-302-06
- 8,0 mm 27-64-302-08
- 10,0 mm 27-64-302-10
- 12,0 mm 27-64-302-12
- 14,0 mm 27-64-302-14
- 16,0 mm 27-64-302-16

13,5 cm, 5 3/8"

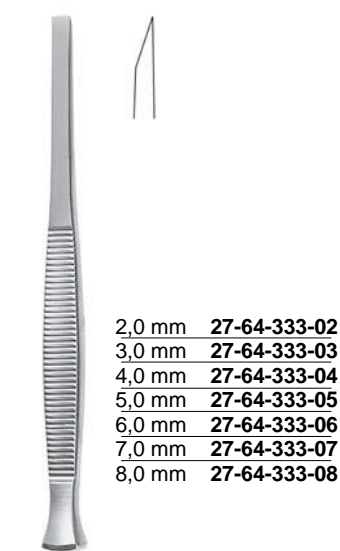

- 2,0 mm 27-64-333-02
- 3,0 mm 27-64-333-03
- 4,0 mm 27-64-333-04
- 5,0 mm 27-64-333-05
- 6,0 mm 27-64-333-06
- 7,0 mm 27-64-333-07
- 8,0 mm 27-64-333-08

**PARTSCH**  
11,5 cm, 4 1/2"

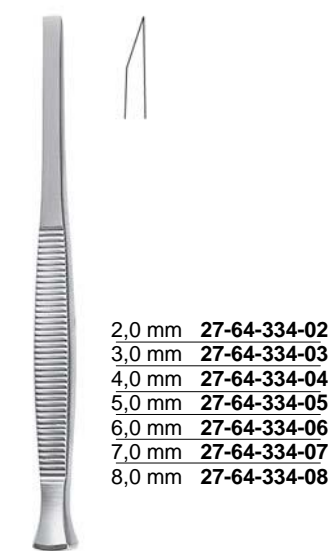

- 2,0 mm 27-64-334-02
- 3,0 mm 27-64-334-03
- 4,0 mm 27-64-334-04
- 5,0 mm 27-64-334-05
- 6,0 mm 27-64-334-06
- 7,0 mm 27-64-334-07
- 8,0 mm 27-64-334-08

**PARTSCH**  
13,5 cm, 5 3/8"

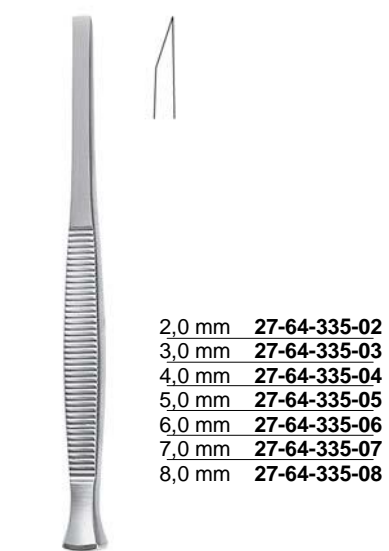

- 2,0 mm 27-64-335-02
- 3,0 mm 27-64-335-03
- 4,0 mm 27-64-335-04
- 5,0 mm 27-64-335-05
- 6,0 mm 27-64-335-06
- 7,0 mm 27-64-335-07
- 8,0 mm 27-64-335-08

**PARTSCH**  
17,0 cm, 6 3/4"

Flachmeißel, Hohlmeißel, Osteotome  
 Chisels, Gouges, Osteotomes  
 Ciseaux-burins, Gouges, Ostéotomes  
 Cinceles, Gubias, Osteótomos  
 Долота для костей, остеотомы



2,0 mm	<b>27-64-337-02</b>
3,0 mm	<b>27-64-337-03</b>
4,0 mm	<b>27-64-337-04</b>
5,0 mm	<b>27-64-337-05</b>
6,0 mm	<b>27-64-337-06</b>
7,0 mm	<b>27-64-337-07</b>
8,0 mm	<b>27-64-337-08</b>

**PARTSCH**  
 11,5 cm, 5¼"



2,0 mm	<b>27-64-336-02</b>
3,0 mm	<b>27-64-336-03</b>
4,0 mm	<b>27-64-336-04</b>
5,0 mm	<b>27-64-336-05</b>
6,0 mm	<b>27-64-336-06</b>
7,0 mm	<b>27-64-336-07</b>
8,0 mm	<b>27-64-336-08</b>

**PARTSCH**  
 13,5 cm, 5¼"



2,0 mm	<b>27-64-332-02</b>
3,0 mm	<b>27-64-332-03</b>
4,0 mm	<b>27-64-332-04</b>
5,0 mm	<b>27-64-332-05</b>
6,0 mm	<b>27-64-332-06</b>
7,0 mm	<b>27-64-332-07</b>
8,0 mm	<b>27-64-332-08</b>

**PARTSCH**  
 17,0cm, 5¾"



**STILLE**  
 20,0 cm, 8"



Fig. 1

gerade, straight,  
 droit, recta, прямые



Fig. 2

gebogen, curved, curva,  
 arqué, изогнутые



Fig. 3

fein, small, fin,  
 fin, тонкий

	Fig. 1	Fig. 2	Fig. 3
6,0 mm	<b>27-64-360-06</b>	-	<b>27-64-361-06</b>
8,0 mm	<b>27-64-360-08</b>	-	<b>27-64-361-08</b>
12,0 mm	<b>27-64-360-12</b>	<b>27-64-359-12</b>	<b>27-64-361-12</b>
10,0 mm	<b>27-64-360-10</b>	<b>27-64-359-10</b>	<b>27-64-361-10</b>
15,0 mm	<b>27-64-360-15</b>	<b>27-64-359-15</b>	<b>27-64-361-15</b>
20,0 mm	<b>27-64-360-20</b>	<b>27-64-359-20</b>	<b>27-64-361-20</b>
25,0 mm	<b>27-64-360-25</b>	<b>27-64-359-25</b>	<b>27-64-361-25</b>
30,0 mm	<b>27-64-360-30</b>	<b>27-64-359-30</b>	<b>27-64-361-30</b>



Flachmeißel, Hohlmeißel, Osteotome  
Chisels, Gouges, Osteotomes  
Ciseaux-burins, Gouges, Ostéotomes  
Cinceles, Gubias, Osteótomos  
Долота для костей, остеотомы



6,0 mm	<b>27-64-362-06</b>	<b>27-64-363-06</b>
8,0 mm	<b>27-64-362-08</b>	<b>27-64-363-08</b>
10,0 mm	<b>27-64-362-10</b>	<b>27-64-363-10</b>
12,0 mm	<b>27-64-362-12</b>	<b>27-64-363-12</b>
15,0 mm	<b>27-64-362-15</b>	<b>27-64-363-15</b>
20,0 mm	<b>27-64-362-20</b>	<b>27-64-363-20</b>
25,0 mm	<b>27-64-362-25</b>	<b>27-64-363-25</b>
30,0 mm	<b>27-64-362-30</b>	<b>27-64-363-30</b>

**STILLE**  
20,0 cm, 8"



4,0 mm	<b>27-64-318-04</b>
6,0 mm	<b>27-64-318-06</b>
8,0 mm	<b>27-64-318-08</b>
10,0 mm	<b>27-64-318-10</b>
12,0 mm	<b>27-64-318-12</b>
14,0 mm	<b>27-64-318-14</b>

**ALEXANDER**  
18,0 cm, 7"



2,0 mm	<b>27-64-319-02</b>
4,0 mm	<b>27-64-319-04</b>
6,0 mm	<b>27-64-319-06</b>
8,0 mm	<b>27-64-319-08</b>
10,0 mm	<b>27-64-319-10</b>
12,0 mm	<b>27-64-319-12</b>
14,0 mm	<b>27-64-319-14</b>

**ALEXANDER**  
18,0 cm, 7"

Flachmeißel, Hohlmeißel, Osteotome  
 Chisels, Gouges, Osteotomes  
 Ciseaux-burins, Gouges, Ostéotomes  
 Cinceles, Gubias, Osteótomos  
 Долота для костей, остеотомы



- 16,0 mm **27-64-350-06**
- 19,0 mm **27-64-350-09**
- 13,0 mm **27-64-350-13**
- 16,0 mm **27-64-350-16**
- 19,0 mm **27-64-350-19**
- 25,0 mm **27-64-350-25**
- 32,0 mm **27-64-350-32**

**SMITH-PETERSEN**  
 20,0 cm, 8"



- 16,0 mm **27-64-351-06**
- 19,0 mm **27-64-351-09**
- 13,0 mm **27-64-351-13**
- 16,0 mm **27-64-351-16**
- 19,0 mm **27-64-351-19**
- 25,0 mm **27-64-351-25**
- 32,0 mm **27-64-351-32**

**SMITH-PETERSEN**  
 20,0 cm, 8"



- 19,0 mm **27-64-352-09**
- 14,0 mm **27-64-352-14**
- 16,0 mm **27-64-352-16**
- 19,0 mm **27-64-352-19**
- 25,0 mm **27-64-352-25**
- 32,0 mm **27-64-352-32**

**SMITH-PETERSEN**  
 20,0 cm, 8"



- 19,0 mm **27-64-353-09**
- 14,0 mm **27-64-353-14**
- 16,0 mm **27-64-353-16**
- 19,0 mm **27-64-353-19**
- 25,0 mm **27-64-353-25**
- 32,0 mm **27-64-353-32**

**SMITH-PETERSEN**  
 20,0 cm, 8"



Flachmeißel, Hohlmeißel, Osteotome, Hämmer  
Chisels, Gouges, Osteotomes, Mallets  
Ciseaux-burins, Gouges, Ostéotomes, Maillets  
Cinceles, Gubias, Osteótomos, Martillos  
Долота для костей, остеотомы, молотки



- 16,0 mm 27-64-451-06
- 15,0 mm 27-64-451-15
- 20,0 mm 27-64-451-20
- 25,0 mm 27-64-451-25
- 30,0 mm 27-64-451-30
- 38,0 mm 27-64-451-38
- 44,0 mm 27-64-451-44
- 50,0 mm 27-64-451-50

**LAMBOTTE**  
24,0 cm, 9½"



- 2,0 mm 27-64-446-02
- 3,0 mm 27-64-446-04
- 4,0 mm 27-64-446-15
- 6,0 mm 27-64-446-20
- 8,0 mm 27-64-446-25
- 10,0 mm 27-64-446-30
- 12,0 mm 27-64-446-38
- 15,0 mm 27-64-446-44

**MINI-LAMBOTTE**  
12,5 cm, 9½"



- 4,0 mm 27-64-450-04
- 6,0 mm 27-64-450-06
- 8,0 mm 27-64-450-08
- 10,0 mm 27-64-450-10
- 13,0 mm 27-64-450-13
- 16,0 mm 27-64-450-16
- 18,0 mm 27-64-450-18
- 20,0 mm 27-64-450-20
- 25,0 mm 27-64-450-25
- 30,0 mm 27-64-450-30
- 38,0 mm 27-64-450-38
- 44,0 mm 27-64-450-44
- 50,0 mm 27-64-450-50

**LAMBOTTE**  
24,0 cm, 9½"



Ø 30 mm  
220 g

**COLLIN**  
20,0 cm, 8"  
27-61-132-20



Ø 22 mm  
200 g

mit Bleifüllung  
lead filled head  
remplissage de plomb  
cabezal relleno de plomo  
со свинцовым наполнением

**PARTSCH**  
18,0 cm, 7"  
27-61-145-18



Ø 45 mm  
300 g

**BERGMANN**  
24,0 cm, 9½"  
27-61-201-24

Flachmeißel, Hohlmeißel, Osteotome  
 Chisels, Gouges, Osteotomes  
 Ciseaux-burins, Gouges, Ostéotomes  
 Cinceles, Gubias, Osteótomos  
 Долота для костей, остеотомы

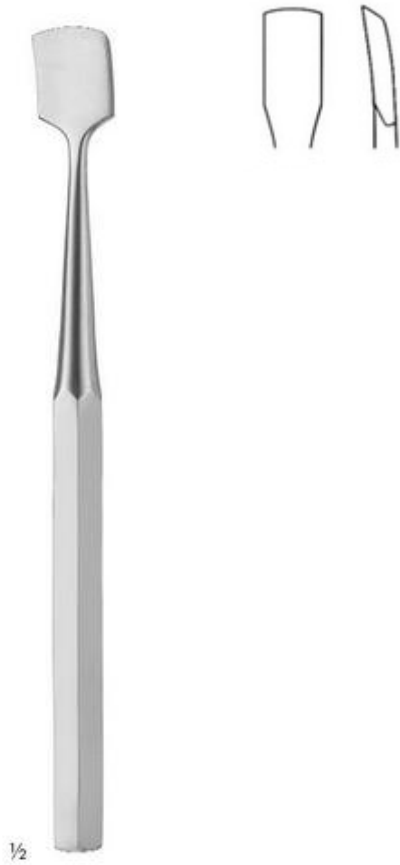

**KEY**  
 19,0 cm, 7½"

- 6,0 mm **27-63-370-06**
- 10,0 mm **27-63-370-10**
- 12,0 mm **27-63-370-12**
- 13,0 mm **27-63-370-13**
- 19,0 mm **27-63-370-19**
- 25,0 mm **27-63-370-25**

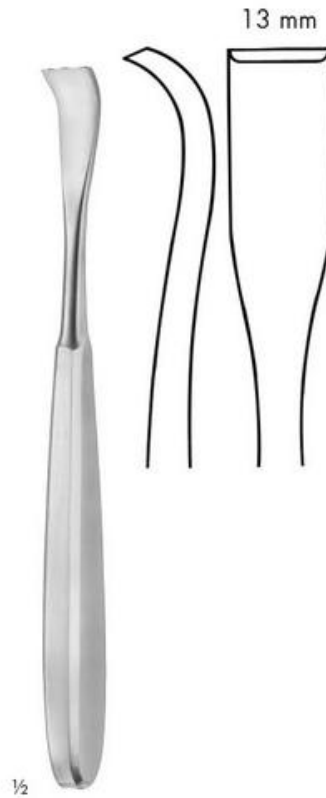

**SCHNEIDER**  
 17,5 cm, 6¾"  
**27-63-377-17**

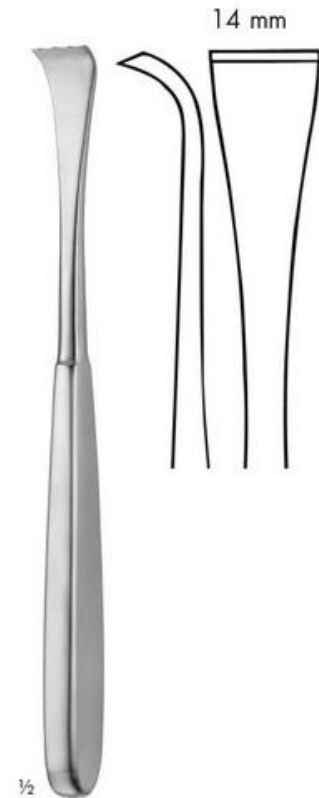

**SCHNEIDER- SAUERBR**  
 19,0 cm, 7½"  
**27-63-379-19**



Hohlmeisselzangen  
Bone Rongeurs  
Pincés-gouges  
Pinzas gubias  
Щипцы для костей



**MINI-FRIEDMANN**  
12,0 cm  
27-66-201-12



**FRIEDMANN**  
15,0 cm  
27-66-202-15



**FRIEDMANN**  
14,0 cm, 5½  
27-66-202-14



**FRIEDMANN**  
14,0 cm, 5½  
27-66-203-14



27-66-205-01



27-66-205-02



17,0 cm, 6¾"  
27-66-207-17



1/1

14,0 cm, 5½  
27-66-207-14

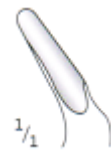

1/1

**CLEVELAND**



27-66-208-18



27-66-208-19



27-66-209-18

**JANSEN**  
18,0 cm, 7"

INK  
2mm

Hohlmeisselzangen  
 Bone Rongeurs  
 Pincés-gouges  
 Pinzas gubias  
 Щипцы для костей



**OLIVECRONA**  
 20,0 cm, 8"  
 27-66-210-20



**UNIVERSAL**  
 13,5 cm, 5"  
 27-66-211-13



**MEAD**  
 16,5 cm, 6½"



27-66-215-01



27-66-215-02



**BEYER**  
 18,0 cm, 7"  
 27-66-319-04 4 mm



zusätzlich  
 gerade 3, 4, 5  
 mm und  
 gebogene  
 3,4, 5 mm



**BEYER**  
 17,0 cm, 6¾"



2 mm  
 27-66-218-01



3 mm  
 27-66-218-02

- 27-66-318-03 3 mm
- 27-66-318-04 4 mm
- 27-66-318-05 5 mm

- 27-66-319-18 3 mm
- 27-66-319-05 5 mm





Hohlmeisselzangen  
Bone Rongeurs  
Pincés-gouges  
Pinzas gubias  
Щипцы для костей



**ZAUFAL-ALEXANDER**  
19,0 cm, 7½"  
27-66-219-19



**HARTMANN**  
18,5 cm, 7½"  
27-66-221-18



**BLUMENTHAL**  
15,5 cm, 6"

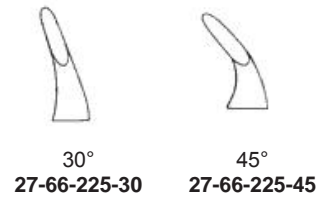

**LUER**  
17,0 cm, 6¾"

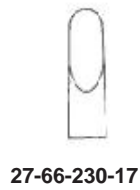

**LUER**  
15,0 cm, 6"



**BACON**  
20,0 cm, 8"  
27-66-241-20

Hohlmeisselzangen  
 Bone Rongeurs  
 Pincés-gouges  
 Pinzas gubias  
 Щипцы для костей

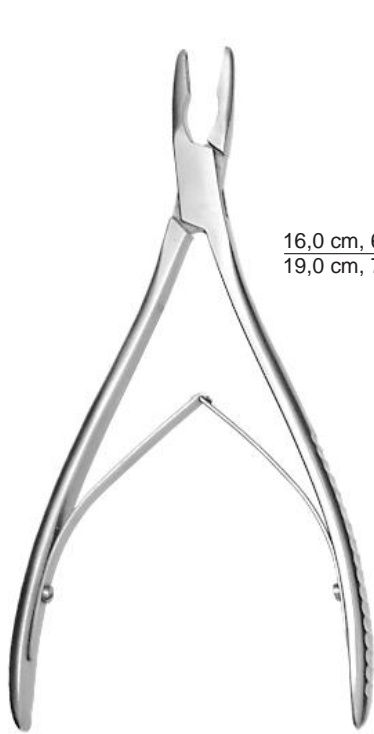

LEMPERT



16,0 cm, 6½" 27-66-236-16 27-66-237-16  
 19,0 cm, 7½" 27-66-236-19 27-66-237-19

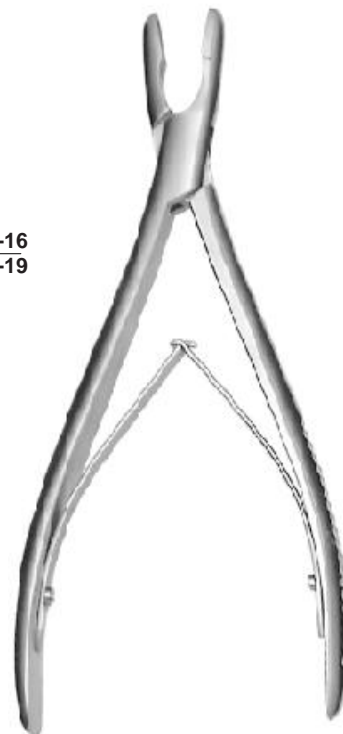

ADSON  
 20,0 cm 8"



27-66-238-20



27-66-239-20

mit Zähne / with teeth /  
 с зубьями  
 27-66-240-20



HAKANSSON  
 17,0 cm, 6¾"  
 27-66-240-17



BANE  
 18,0 cm, 7"  
 27-66-242-18



DEFOURMENTEL  
 19,0 cm, 7½"  
 27-66-260-19



MARQUARDT  
 20,0 cm, 8"  
 27-66-301-20



Hohlmeisselzangen  
Bone Rongeurs  
Pincés-gouges  
Pinzas gubias  
Щипцы для костей



**MAYFIELD**  
17,0 cm, 6¾" **27-66-303-17**  
20,0 cm, 8" **27-66-303-20**

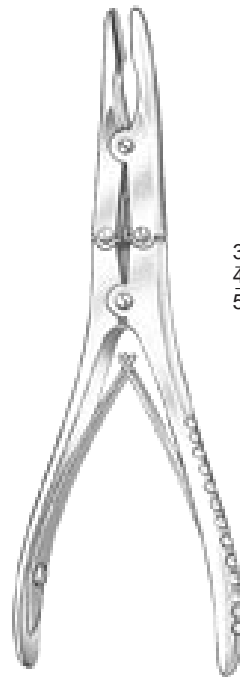

**BÖHLER**  
15,0 cm, 6"

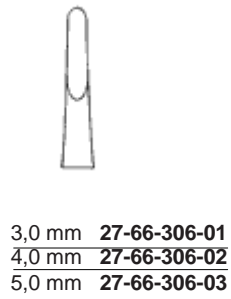

3,0 mm **27-66-306-01**  
4,0 mm **27-66-306-02**  
5,0 mm **27-66-306-03**



3,0 mm **27-66-307-01**  
4,0 mm **27-66-307-02**  
5,0 mm **27-66-307-03**



**KLEINERT-KUTZ**  
15,0 cm, 6"



2 x 13 mm  
**27-66-311-02"**



3 x 8 mm  
**27-66-311-03"**



**RUSKIN**

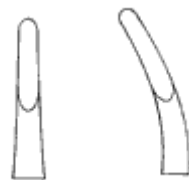

15,0 cm, 6"



18,0 cm, 7"



23,0 cm, 9"

2,0 mm	<b>27-66-315-15</b>	<b>27-66-317-15</b>	-	-	-
3,0 mm	<b>27-66-316-15</b>	<b>27-66-318-15</b>	-	-	-
4,0 mm	-	-	<b>27-66-323-18</b>	<b>27-66-327-18</b>	-
5,0 mm	-	-	<b>27-66-324-18</b>	<b>27-66-328-18</b>	<b>27-66-331-18</b>
6,0 mm	-	-	<b>27-66-325-18</b>	<b>27-66-329-18</b>	<b>27-66-332-18</b>
7,0 mm	-	-	<b>27-66-326-18</b>	<b>27-66-330-18</b>	<b>27-66-364-18</b>

Hohlmeisselzangen  
 Bone Rongeurs  
 Pincès-gouges  
 Pinzas gubias  
 Щипцы для костей



**BEYER**  
 18,0 cm, 7"



27-66-317-18



27-66-319-18



**ZAUFAL-JANSEN**  
 18,0 cm, 7"  
 27-66-321-18



**ROETTGEN-RUSKIN**  
 24,0 cm, 9½"  
 27-66-331-24



**SEMB**  
 22,5 cm, 9" 27-66-341-22  
 27,0 cm, 10½" 27-66-341-27



**STILLE-RUSKIN**  
 23,0 cm, 9"  
 27-66-345-23



**LEKSELL-STILLE**  
 24,0 cm, 9½"

Maulbreite / bite / ширина губок	
3 x 16 mm	27-64-448-03
4 x 16 mm	27-64-448-04
5 x 16 mm	27-64-448-05
6 x 16 mm	27-64-448-06
7 x 16 mm	27-64-448-07
8 x 16 mm	27-64-448-08



Hohlmeisselzangen  
Bone Rongeurs  
Pincés-gouges  
Pinzas gubias  
Щипцы для костей



Maulbreite / bite /  
ширина губок  
3 x 16 mm 27-64-449-03  
4 x 16 mm 27-64-449-04  
5 x 16 mm 27-64-449-05  
6 x 16 mm 27-64-449-06  
7 x 16 mm 27-64-449-07  
8 x 16 mm 27-64-449-08

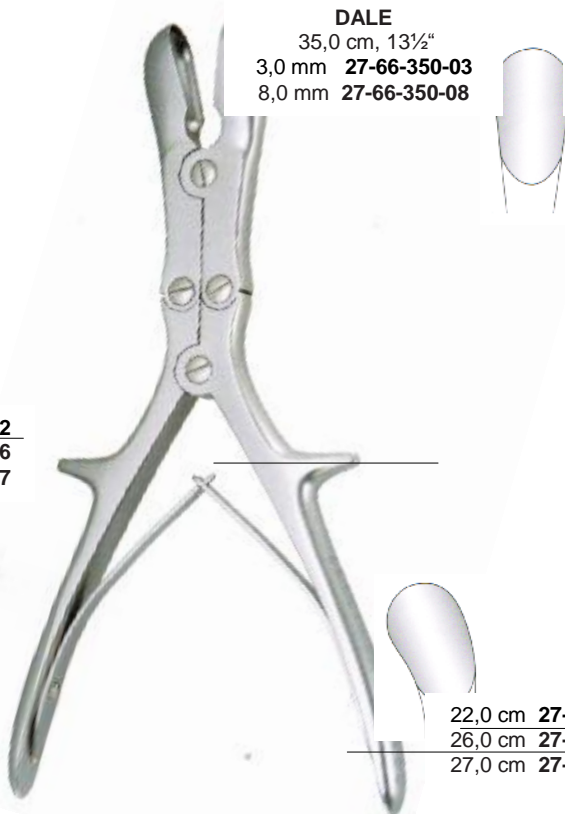

**DALE**  
35,0 cm, 13½"  
3,0 mm 27-66-350-03  
8,0 mm 27-66-350-08



27-66-352-22  
27-66-352-26  
27-66-354-27

27-66-356-01



**STILLE**  
23,0 cm, 9"  
5 x 14 mm 27-66-358-23  
6 x 14 mm 27-66-359-23

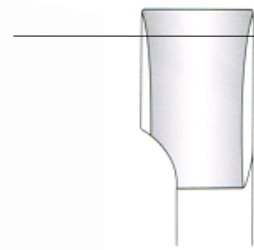

27-66-356-02

22,0 cm 27-66-353-22  
26,0 cm 27-66-353-26  
27,0 cm 27-66-355-27

Hohlmeisselzangen  
 Bone Rongeurs  
 Pincés-gouges  
 Pinzas gubias  
 Щипцы для костей



**FRYKHOLM**  
 24,0 cm, 9½"  
 4 mm **27-66-357-04**  
 8 mm **27-66-357-08**

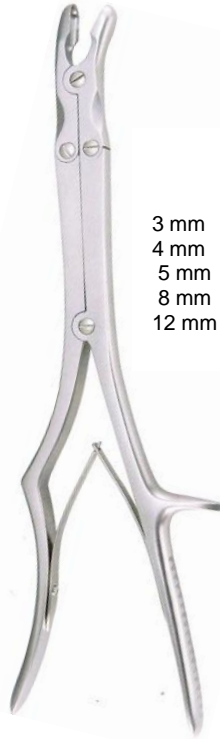

**SYPERT**  
 36,0 cm, 14¼"

	ohne Zähne without teeth без зубьев	mit Zähne with teeth с зубьями
3 mm	<b>27-66-359-03</b>	-
4 mm	<b>27-66-359-04</b>	-
5 mm	<b>27-66-359-05</b>	-
8 mm	<b>27-66-359-08</b>	<b>27-66-358-08</b>
12 mm	<b>27-66-359-12</b>	<b>27-66-358-12</b>



**ECHLIN**  
 23,0 cm, 9"



**SMITH-PETERSEN**  
 24,0 cm, 9½"



3,0 mm	<b>27-66-368-03</b>	<b>27-66-368-03</b>
4,0 mm		<b>27-66-368-04</b>
5,0 mm		<b>27-66-368-05</b>

**ECHLIN**  
 23,0 cm, 9"



2 x 10 mm 27-66-361-01  
3 x 10 mm 27-66-361-02  
4 x 10 mm 27-66-361-03





Hohlmeisselzangen  
 Bone Rongeurs  
 Pincès-gouges  
 Pinzas gubias  
 Щипцы для костей



**PENNYBACKER**  
 20,0 cm, 8"  
 27-66-372-20



**FALCONER**  
 20,5 cm, 8<sup>3</sup>/<sub>8</sub>"  
 6 mm 27-66-373-20



**TROTTER**  
 20,5 cm, 8<sup>3</sup>/<sub>8</sub>"  
 10 mm 27-66-374-20



**WILMS**  
 20,5 cm, 8<sup>3</sup>/<sub>8</sub>"  
 27-66-375-20



**NORTHFIELD**  
 20,5 cm, 8<sup>3</sup>/<sub>8</sub>"  
 27-66-376-20

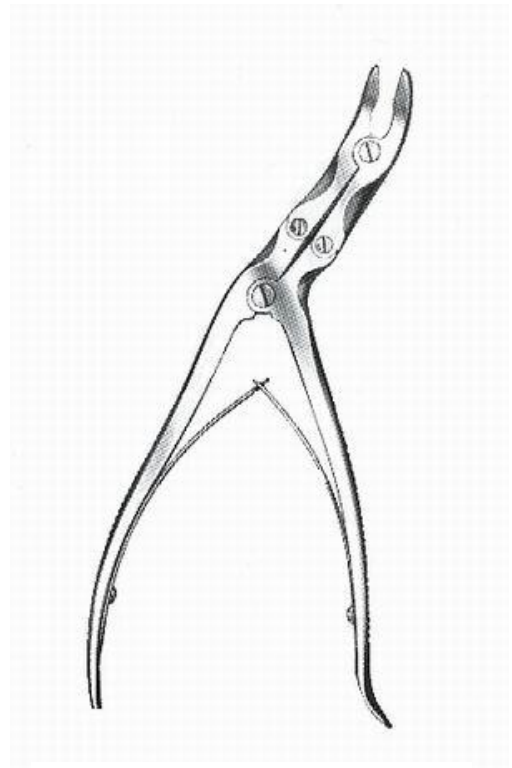

**SCAGLIETTI**  
 26,0 cm, 10<sup>1</sup>/<sub>2</sub>"  
 27-66-370-26 recht / right / правый  
 27-66-371-26 links / left / левый





Bone  
Pincers  
Pinzas  
Щипцы

Knochensplitterzangen  
cutting forceps  
gouges  
gubias  
для костей



4 mm 27-66-506-16

**COTTLE KAZANJIAN**  
19,0 cm, 7½"  
27-66-500-19



**CLEVELAND-GARDNER**  
16,0 cm, 6½"  
4 mm 27-66-505-16

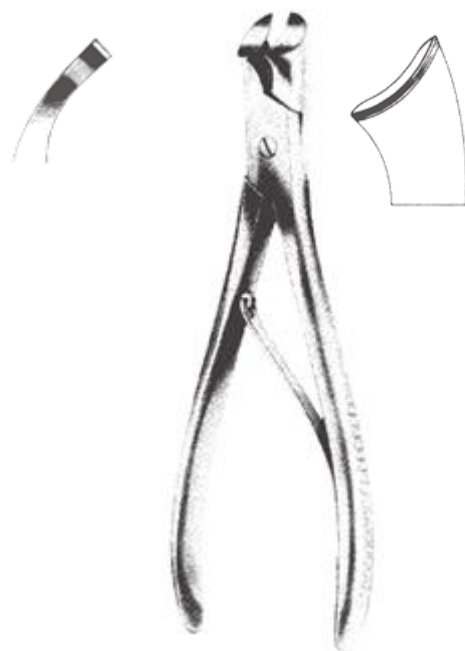

**MARKWALDER**  
20,0 cm, 8"  
27-66-507-20

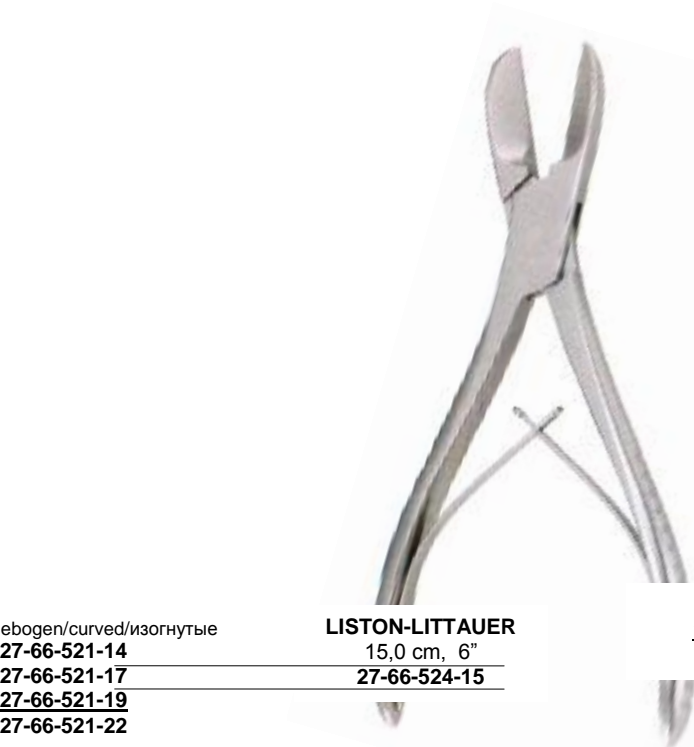

gebogen/curved/изогнутые  
27-66-521-14  
27-66-521-17  
27-66-521-19  
27-66-521-22

**LISTON-LITTAUER**  
15,0 cm, 6"  
27-66-524-15



**CLEVELAND**  
15,0 cm 27-66-527-15  
17,0 cm 27-66-527-17



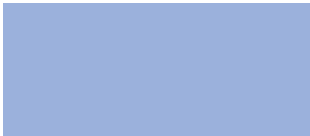

**Knochensplitterzangen**  
**Bone cutting forceps**  
**Pinces-gouges**  
**Pinzas gubias**  
**Щипцы для костей**

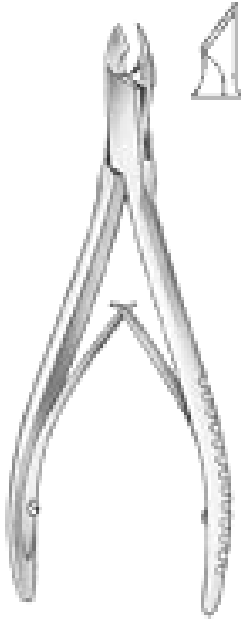

**RUSKIN- LISTON**

18,5 cm 7¼"

gerade/straight/прямые gebogen/curved/изогнутые  
**27-66-602-18 27-66-603-18**

gerade/straight/прямые gebogen/curved/изогнутые  
**27-66-604-18 27-66-605-18**

cm, 4½"  
**27-66-529-12**



**SEMB**  
 24,0 cm 9"  
**27-66-633-24**



**MC INDOE**  
 17,0 cm 7"  
 gebogen/curved/изогнутые  
**27-66-607-17**



**BÖHLER (WALTON-LISTON)**

15,0 cm 5¾"

gerade/straight/прямые gebogen/curved/изогнутые  
**27-66-608-15 27-66-609-15**



Knochensplitterzangen  
Bone cutting forceps  
Pincès-gouges  
Pinzas gubias  
Щипцы для костей



23,0 cm 9" **27-66-621-23**  
27,0 cm 10½" **27-66-621-27**

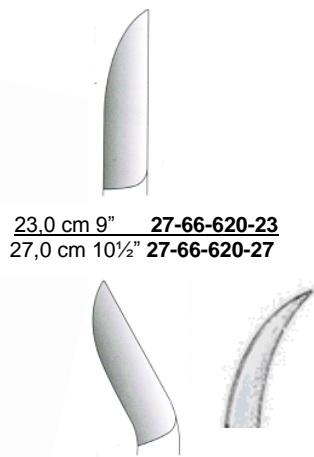

23,0 cm 9" **27-66-620-23**  
27,0 cm 10½" **27-66-620-27**

**KLEINERT KUTZ**  
15,0 cm, 6"



**27-66-635-15**



**27-66-634-15**

27,0 cm 10½" **27-66-627-27**

E-LISTON

**EMERGENCY INSTRUMENTS  
TO REMOVE DAMAGED AND BROKEN BONE SCREWS  
АВАРИЙНЫЙ НАБОР ИНСТРУМЕНТОВ  
ДЛЯ УДАЛЕНИЯ ПОВРЕЖДЕННЫХ И СЛОМАННЫХ  
И ВИНТОВ ДЛЯ КОСТЕЙ**







EMERGENCY INSTRUMENTS TO REMOVE DAMAGED AND BROKEN BONE SCREWS  
АВАРИЙНЫЙ НАБОР ИНСТРУМЕНТОВ ДЛЯ УДАЛЕНИЯ ПОВРЕЖДЕННЫХ И СЛОМАННЫХ И ВИНТОВ ДЛЯ КОСТЕЙ

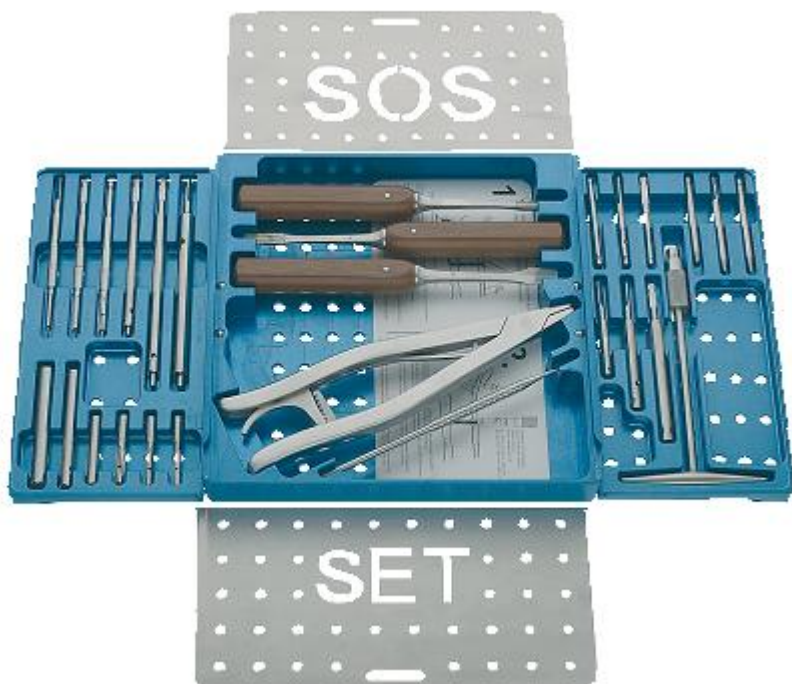

SCREW-EXTRACTION-SET  
27-54-09-25-000  
complete

CONTAINER IID  
300-010  
285 x 280 mm



RECOMMENDED FOR STERILIZATION  
CONTAINER FOR  
27-54-09-25-000  
complete



CONTAINER BOTTOM  
305-100  
285 x 280 x 100 mm

27-54-09-25-0000-31  
TRAY(Empty)



SET - LISTING FOR SET: 27-54-09-25-000 SCREW- EXTRACTION - SET COMPLETE		
REF. - NO.:	PRODUCT - DESCRIPTION:	
27-54-09-25-0000-31	AI-Tray for Screw-Extraction Set-27-54-09-25-000	-1-Pcs.
28-09-15-1603	Conical Extraction Screw for 1.5 / 2.0 mm Screws	-1-Pcs.
28-09-27-1603	Conical Extraction Screw for 2.7 / 3.5 / 4.0 mm Screws	-1-Pcs.
28-09-45-1603	Conical Extraction Screw for 4.5 / 5.0 / 6.5 / 7.0 mm Screws	-1-Pcs.
28-09-15-1601	Extraction Bolt for 1.5 mm Screws	-1-Pcs.
28-09-20-1601	Extraction Bolt for 2.0 mm Screws	-1-Pcs.
28-09-27-1601	Extraction Bolt for 2.7 mm Screws	-1-Pcs.
28-09-35-1601	Extraction Bolt for 3.5 / 4.0 mm Screws	-1-Pcs.
28-09-45-1601	Extraction Bolt for 4.5 mm Screws	-1-Pcs.
28-09-65-1601	Extraction Bolt for 5.0 / 6.5 / 7.0 mm Screws	-1-Pcs.
28-09-15-1602	Hollow Reamer for 1.5 mm Screws	-1-Pcs.
28-09-20-1602	Hollow Reamer for 2.0 mm Screws	-1-Pcs.
28-09-27-1602	Hollow Reamer for 2.7 mm Screws	-1-Pcs.
28-09-35-1602	Hollow Reamer for 3.5 / 4.0 mm Screws	-1-Pcs.
28-09-45-1602	Hollow Reamer for 4.5 mm Screws	-1-Pcs.
28-09-65-1602	Hollow Reamer for 5.0 / 6.5 / 7.0 mm Screws	-1-Pcs.
28-09-15-1602-03	Spare Reamer (Reamer Tube) for Hollow Reamer 1.5 mm (used for 1.5 mm Screws)	-1-Pcs.
28-09-20-1602-03	Spare Reamer (Reamer Tube) for Hollow Reamer 2.0 mm (used for 2.0 mm Screws)	-1-Pcs.
28-09-27-1602-03	Spare Reamer (Reamer Tube) for Hollow Reamer 2.7 mm (used for 2.7 mm Screws)	-1-Pcs.
28-09-35-1602-03	Spare Reamer (Reamer Tube) for Hollow Reamer 3.5 / 4.0 mm (used for 3.5 / 4.0 mm Screws)	-1-Pcs.
28-09-45-1602-03	Spare Reamer (Reamer Tube) for Hollow Reamer 4.5 mm (used for 4.5 mm Screws)	-1-Pcs.
28-09-65-1602-03	Spare Reamer (Reamer Tube) for Hollow Reamer 5.0 / 6.5 / 7.0 mm (used for 5.0 / 6.5 / 7.0 mm Screws)	-1-Pcs.
27-46-16-1800	Sharp Hook, length 155 mm	-1-Pcs.
27-21-03-00-1600	Mini lexer Gouge, 4 mm	-1-Pcs.
27-21-03-00-1601	Mini lexer Gouge, 6 mm	-1-Pcs.
27-21-03-00-1603	Mini lexer Gouge, 10 mm	-1-Pcs.
	Screw Holding Forceps 20.5 cm / 8"	-1-Pcs.
27-06-16-1600	T-Handle, large with AO-Quickcoupling lenght 160 mm	-1-Pcs.
27-54-09-25-000-01	Template for use Broken Screw-Extraction Instruments (Guide Manual for Use)	-1-Pcs.

1.

Bitte Gebrauchsanweisung vor dem Sterilisieren aus der Box entfernen.  
Please remove the instruction before sterilisation.

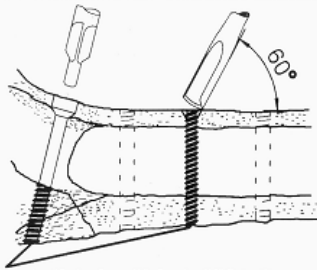

Abgebrochene Schrauben / Broken Screw / Vis Cassées / Viti Spezzate

Freilegung des Schraubenkanals und der abgebrochenen Schraube als Zentrierung für den Hohlfräser, mit Kopfraumfräser oder Spezialmeißel.

Exposure of the screw hole and the broken screw, which serves to centre the hollow reamer, using a countersink or special chisel.

Préparation de l'orifice et de la vis cassée pour centrer le trépan au moyen de la fraise à chambrer ou du ciseau gouge spécial.

Messa a nudo del canale della vite e della vite spezzata tramite la fresa per sede conica oppure opposto scalpello.

2.

Zentrierbolzen  
Centering tip  
Guide de centrage  
Perno di centraggio

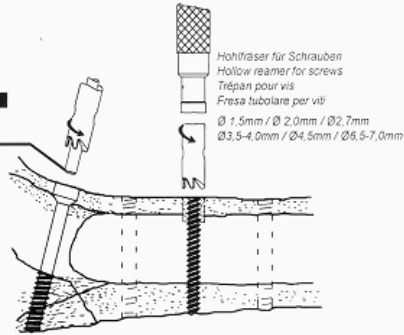

Hohlfräser für Schrauben  
Hollow reamer for screws  
Trépan pour vis  
Fresa tubolare per viti  
Ø 1,5mm / Ø 2,0mm / Ø 2,7mm  
Ø 3,5-4,0mm / Ø 4,5mm / Ø 6,5-7,0mm

Mit Hohlfräser Zugang für den Extraktionsbolzen ausfräsen, Schraubenrichtungen beachten. Bei Hohlfräser Zentrierbolzen entfernen wenn der Schraubenstumpf erreicht ist. The orientation of the screw is noted. The hole for the extraction bolt is cut using the hollow reamer. The centering tip is removed as soon as it contacts the screw fragment.

Préparer l'approche pour le boulon d'extraction à l'aide du trépan en observant la direction de la direction de la vis. Enlever le guide de centrage au moment où il entre en contact la vis cassée.

Aprve la via per il perno d'estrazione con la fresa tubolare osservando la direzione della vite. Estrarre il perno di centraggio dalla fresa tubolare appena si raggiunge il resto della vite.

3.

Extraktionsbolzen für Schrauben  
Extracting bolt for screw  
Boulon d'extraction pour vis  
Perno d'estrazione per viti  
Ø 1,5mm / Ø 2,0mm / Ø 2,7mm  
Ø 3,5-4,0mm / Ø 4,5mm / Ø 6,5-7,0mm

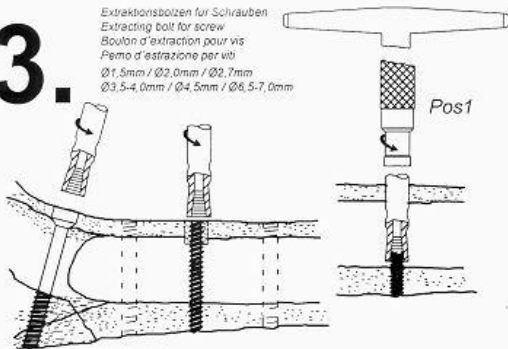

Mit Linksdrehung den Extraktionsbolzen kraftig auf den Schraubenstumpf drücken und herausdrehen.

The extraction bolt is strongly pressed onto the screw fragment and rotated anticlockwise, thus allowing the fragment to be screwed out.

Extraction de la vis en enfonceant avec force le boulon sur la vis cassée puis en le tournant de droite à gauche.

Premere forte il perno d'estrazione sulla vite spezzata ed estrarla ed estrarla girando a sinistra.

Konische Extraktions Schraube für  
Conical extraction screw  
Vis d'extraction conique  
Vite d'estrazione coniche

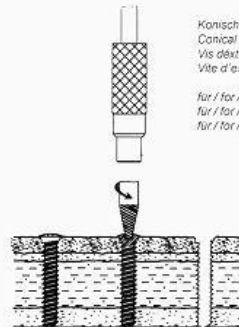

tur / for / pour / per Ø 1,5/2,0mm  
tur / for / pour / per Ø 2,7/3,5/4,0mm  
tur / for / pour / per Ø 4,5/6,5/7,0mm

Bei beschädigtem Innensechskant passende konische Extraktionschraube mit Griffstück Pos1 unter Druck und Linksdrehung möglichst senkrecht eindrehen und Schraube entfernen.

If the hexagonal socket is damaged, insert the fitting conical extraction screw with handle Pos1 as vertically as possible under pressure and left-hand rotation and remove the screw.

En cas d'une empreinte hexagonale intérieure endommagée, visser la vis d'extraction juste avec poignée Pos1 sous pression et rotation inversée aussi verticalement que possible et enlever la vis. In caso che l'esagono incassato è danneggiato, avvitare la vite conica per estrazione adatta con l'impugnatura Pos1 sotto pressione e torsione sinistrorsa il più verticalmente possibile e rimuovere la vite.



### Conical Extraction Screws



28-09-15-1603	Conical Extraction Screw for 1.5 / 2.0 mm Screws
28-09-27-1603	Conical Extraction Screw for 2.7 / 3.5 / 4.0 mm Screws
28-09-45-1603	Conical Extraction Screw for 4.5 / 5.0 / 6.5 / 7.0 mm Screws

### Hollow Reamers complete



28-09-15-1602	Hollow Reamer for 1.5 mm Screws
28-09-20-1602	Hollow Reamer for 2.0 mm Screws
28-09-27-1602	Hollow Reamer for 2.7 mm Screws
28-09-35-1602	Hollow Reamer for 3.5 / 4.0 mm Screws
28-09-45-1602	Hollow Reamer for 4.5 mm Screws
28-09-65-1602	Hollow Reamer for 5.0 / 6.5 / 7.0 mm Screws

### Extraction Bolts

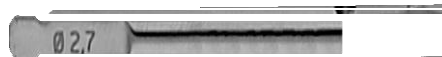

28-09-15-1601	Extraction Bolt for 1.5 mm Screws
28-09-20-1601	Extraction Bolt for 2.0 mm Screws
28-09-27-1601	Extraction Bolt for 2.7 mm Screws



28-09-35-1601	Extraction Bolt for 3.5 / 4.0 mm Screws
28-09-45-1601	Extraction Bolt for 4.5 mm Screws
28-09-65-1601	Extraction Bolt for 5.0 / 6.5 / 7.0 mm Screws

**Hollow Reamers Tube**

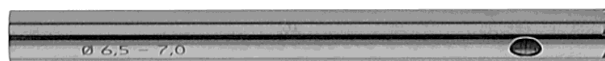

28-09-15-1602-03	Speare Reamer (Reamer Tube) for Hollow Reamer 1.5 mm (used for 1.5 mm Screws)
28-09-20-1602-03	Speare Reamer (Reamer Tube) for Hollow Reamer 2.0 mm (used for 2.0 mm Screws)
28-09-27-1602-03	Speare Reamer (Reamer Tube) for Hollow Reamer 2.7 mm (used for 2.7 mm Screws)
28-09-35-1602-03	Speare Reamer (Reamer Tube) for Hollow Reamer 3.5 / 4.0 mm (used for 3.5 / 4.0 mm Screws)
28-09-45-1602-03	Speare Reamer (Reamer Tube) for Hollow Reamer 4.5 mm (used for 4.5 mm Screws)
28-09-65-1602-03	Speare Reamer (Reamer Tube) for Hollow Reamer 5.0 / 6.5 / 7.0 mm (used for 5.0 / 6.5 / 7.0 mm Screws)

**Hollow Reamers Central Bolt**



28-09-15-1602-02	Central Bolt used with Hollow Reamer for 1.5 mm
28-09-20-1602-02	Central Bolt used with Hollow Reamer for 2.0 mm
28-09-27-1602-02	Central Bolt used with Hollow Reamer for 2.7 mm
28-09-35-1602-02	Central Bolt used with Hollow Reamer for 3.5 / 4.0 mm
28-09-45-1602-02	Central Bolt used with Hollow Reamer for 4.5 mm
28-09-65-1602-02	Central Bolt used with Hollow Reamer for 5.0 / 6.5 / 7.0 mm

**Sharp Hook**



27-46-16-1800
length 155 mm





T-Handle Large with AO-Quickcoupling

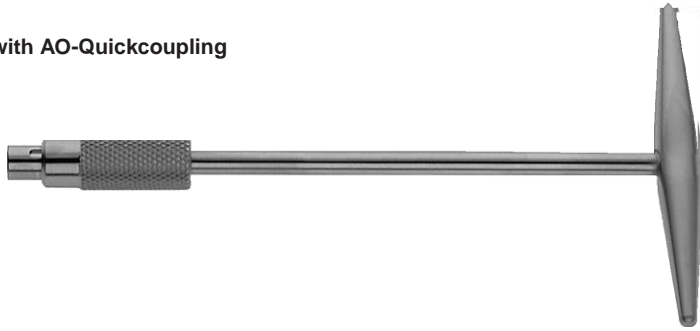

<b>27-06-16-1600</b>
length 160 mm

Screw Holding Forceps



<b>27-01-21-1603</b>
length 20,5 cm / 8"

Mini Lexer Gouge



<b>27-21-03-00-1600</b>
length 4 mm

Mini Lexer Gouge



<b>27-21-03-00-1601</b>
length 6 mm

Mini Lexer Gouge



<b>27-21-03-00-1603</b>



Leicht  
Medizintechnik

## Drahtfasszangen Wire and Pin Bender Щипцы (зажимы)







22cm / 8½" **27-01-22-1601**  
25cm / 10" **27-01-25-1601**  
30cm / 12" **27-01-30-1601**

**Spitzmaul Feststellzange**  
**Needle Nosed Locking Pliers**  
**Щипцы (плоскогубцы)**  
блокируемые, с узким носиком



18cm / 7" **27-01-18-1601**  
20cm / 8" **27-01-20-1601**  
24cm / 9 ½" **27-01-24-1601**

**Feststellzange**  
**Locking Pliers**  
**Щипцы (зажим)**  
(силовой, блокируемый)

Bitte geben Sie bei einer Bestellung an, ob die Zange mit dem Auszugshammer verwendet wird, da die Mittelschraube in zweierlei Ausführungen erhältlich ist!  
Please advice in your order if the pliers are used with the extraction hammer because a holding screw for extraction hammer will be needed!  
При заказе необходимо указать, что зажим будет использоваться один или с молотком.



35cm / 13 ¾" = 400g **27-01-35-1601**  
40cm / 15 ¾" = 700g **27-01-40-1601**

**Auszugshammer für Feststellzange** mit Auszugshammer  
**Extraction mallet for Locking Pliers** with Extraction Hammer  
**Экстрактор с молотком**



**Feststellzange & Spitzmaul Feststellzange mit Auszugshammer**  
**Locking Pliers & Needle Nosed Locking Pliers with Extraction Hammer**  
**Щипцы (зажим) блокируемые с экстрактором**

Mögliche Varianten / possible variations / возможные варианты:

für Feststellzange / for Locking Pliers / для держащих щипцов

18cm: 27-01-18-1604 + 27-01-35-1601 = **27-01-39-1601**

20cm: 27-01-20-1605 + 27-01-35-1601 = **27-01-41-1601**

24cm: 27-01-24-1605 + 27-01-40-1601 = **27-01-47-1601**

für Spitzmaul Feststellzange / for Needle Nosed Locking Pliers /  
для остроконечных держащих щипцов

22cm: 27-01-22-1602 + 27-01-35-1601 = **27-01-35-1601**

25cm: 27-01-25-1602 + 27-01-35-1601 = **27-01-45-1601**

30cm: 27-01-27-1605 + 27-01-40-1601 = **27-01-51-1601**



30,0 cm

**27-01-30-1607**

**Spitzmaul Feststellzange**

**Needle Nosed Locking Pliers**

**Щипцы (плоскогубцы) блокируемые, с узким носиком**

Parallele Backen bei Abstand 5mm. Bei eingelegtem 5mm Stab liegen beide Backen parallel in voller Länge am Draht an.

Parallel cheeks with distance 5 mm. With inlaid 5 mm of stick both cheeks lie close in parallel in full length in the wire.

Параллельные щёки с расстоянием 5 мм. При наложении 5 мм прутка щечки остаются параллельными по всей длине прутка.



23,0 cm

**27-01-23-0100**

**Abbrechzange / Shoe puller / Щипцы (зажим) для удаления**

Zange zum Abbrechen der Gewindeflügel bei Mono und Polyaxial-Schrauben

Tongs to the cessation of the thread wings with Mono and Polyaxially screws

Щипцы (зажим) для удаления моно и полиаксиальных винтов



18,5cm / 7 1/2"  
**27-01-18-1602**  
Drahtziehzange  
Parallel Pliers  
Щипцы (зажим) параллельные



18,5cm / 7 1/2"  
**27-03-18-2401**  
Drahtziehzange mit Seitenschneider  
Schneidkapazität bis Ø1,6mm  
Parallel Pliers with Side Cutter  
max cap Ø1,6mm  
Параллельные плоскогубцы / кусачки  
max Ø1,6mm

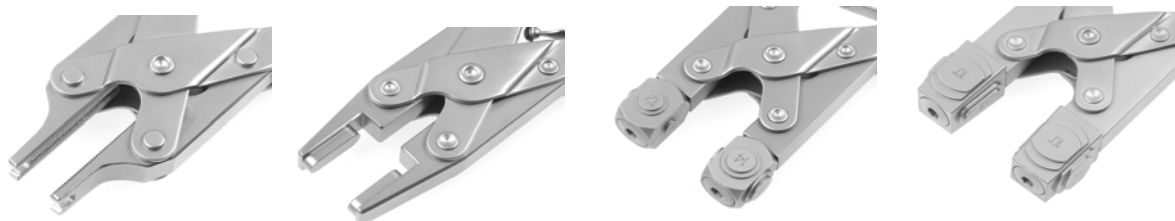

Kundenspezifische Backen / Customized Jaws / Изготовление щечек по спец.заказу заказчика



**Stabhaltezaugen**  
**Rod Holding Forceps**  
**Щипцы для держания стержней**



28,0 cm **27-01-28-1801**  
**Stabhaltezange**, schweres Modell, gerade, für Stäbe mit Ø6,0mm  
**Rod Holding Forceps** heavy model, str., for Ø6,0mm rods  
**Щипцы** для держания стержней, усиленная модель, прямые, для Ø6,0mm



28,0 cm **27-01-28-1806**  
**Stabhaltezange**, schweres Modell, gerade, für Stäbe mit Ø3,0mm  
**Rod Holding Forceps**, heavy model, str. for Ø3,0mm rods  
**Щипцы** для держания стержней, усиленная модель, прямые, для Ø3,0mm



28,0 cm **27-01-28-1802**  
**Stabhaltezange**, schweres Modell, gerade, für Stäbe mit Ø6,0mm  
**Rod Holding Forceps**, heavy model, str., for Ø6,0mm rods  
**Щипцы** для держания стержней, усиленная модель, прямые, для Ø6,0mm

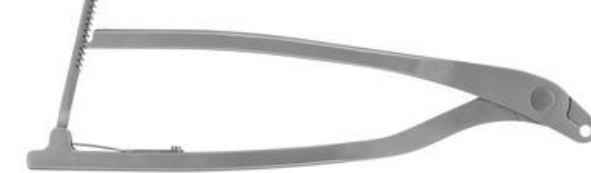

28,0 cm **27-01-28-1803**  
**Stabhaltezange**, schweres Modell, gewinkelt, für Stäbe mit Ø6,0mm  
**Rod Holding Forceps**, heavy model, for Ø 6,0mm rods  
**Щипцы** для держания стержней, усиленная модель, изогнутые, для Ø6,0mm



28,0 cm **27-01-28-1804**  
**Stabhaltezange**, schweres Modell, gewinkelt, für Stäbe mit Ø6,35mm  
**Rod Holding Forceps**, heavy model, for Ø6.35mm rods  
**Щипцы** для держания стержней, усиленная модель, изогнутые, для Ø6,35mm

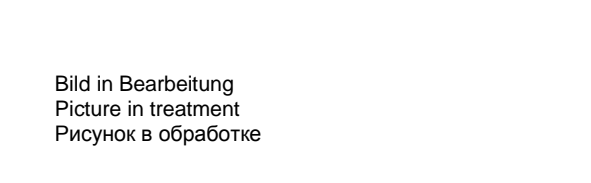

30,0 cm **27-01-30-1800**  
**Stabhaltezange**, mittelschweres Modell, für Stäbe Ø6,0-6,35mm, Glatte Halteflächen  
**Rod Holding Forceps**, moderately severe model, for Ø6,0-6.35 mm rods, Smooth hold surfaces  
**Щипцы** для держания стержней, среднеусиленная модель, для Ø6,0-6,35mm

30,0 cm **27-01-30-1602**  
**Stabhaltezange**, schweres Modell, für Stäbe Ø6,0-6,35mm Glatte Halteflächen  
**Rod Holding Forceps**, heavy model for Ø6,0-6.35mm rods, Smooth hold surfaces  
**Щипцы** для держания стержней, усиленная модель, для Ø6,0-Ø6,35mm

Bild in Bearbeitung  
Picture in treatment  
Рисунок в обработке



30 cm **27-01-24-1807**

**Stabhaltezange**, schweres Modell, für Stäbe Ø6,0-6,35mm, Gezahnte Halteflächen mit Lösehebel  
**Rod Holding Forceps**, heavy model, for Ø6,0-6.35mm rods, Serrated hold surfaces  
**Щипцы для держания стержней**, усиленная модель, для Ø6,0-6,35mm

19,0 cm

**Stabhaltezange gerade**  
für Stäbe Ø4,5mm : 28-01-19-1600  
für Stäbe Ø6,0mm : 28-01-19-1601  
für Stäbe Ø5,0mm : 28-01-19-1602

**Rod Holding Forceps**  
for Ø4,5 mm rods : 28-01-19-1600  
for Ø6,0 mm rods : 28-01-19-1601  
for Ø5,0 mm rods : 28-01-19-1602

**Щипцы для держания стержней, пря-**  
**для Ø4,5 mm прутик : 28-01-19-1600**  
**для Ø6,0 mm прутик : 28-01-19-1601**  
**для Ø5,0 mm прутик : 28-01-19-1602**



мые



24 cm / 9,5"  
**30-05-41-1601**  
**DHS-Bohrer** Fräserlänge 41mm  
**DHS-Drill** Millinglength 41mm  
**Сверло Зенкер DHS** длина 41 мм

24cm / 9,5"  
**30-05-26-1601**  
**DCS-Bohrer kurz** Fräserlänge 26mm  
**DCS-Drill short** Millinglength 26mm  
**Сверло Зенкер DCS** короткое, длина 26mm



**27-05-021-032**  
**Gewindeschneider** ø 3,5 110/50 mm AO Steigung 1,25 mm (cortical)  
**Tap AO Shaft** ø 3,5 mm with cortical Pitch 1,25 mm used for ø3,5 mm cortical screws  
**Метчик** кортикальный Ø3,5мм под зажим АО

**27-05-021-045**  
**Gewindeschneider** ø 4,5, AO, Steigung 1,75 mm (cortical)  
**Tap AO Shaft** ø 4,5 mm with cortical Pitch 1,75 mm used for ø4,5 mm cortical screws  
**Метчик** кортикальный Ø4,5мм под зажим АО

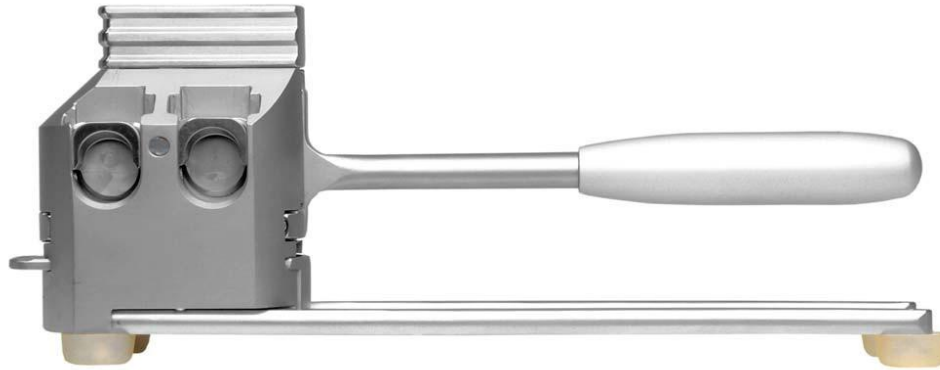

28 cm / 11"  
28-03-28-1602  
Knochenspan / -schaber  
Bonescraper  
Измельчитель кости

DBGM 200 00 516 2





42cm / 16,5"  
**28-03-42-2401**  
**Knochenmühle**  
**Bone Mill**  
**Костная мельница** (измельчитель кости)

Schneidtrommel und Spannhand bitte bei **der Bestellung gesondert angeben**



**28-03-04-1801**  
**Schneidtrommel** mit 4 Schneiden in Reihe  
Bohrungs - Ø 4,2mm  
**Cutting cylinder** - Ø 4,2mm  
**Измельчающий цилиндр** - Ø 4,2mm



**28-01-00-1601**  
**Spannhand** zur Befestigung  
der Knochenmühle am OP-Tisch  
**Fixation clamp, stainless**  
**Зажим фиксирующий**



**28-03-05-1801**  
**Schneidtrommel** mit 4 Schneiden in Reihe  
Bohrungs - Ø 3,2mm  
**Cutting cylinder** - Ø 3,2mm  
**Резак цилиндрический**  
с отверстиями Ø3,2mm

- Schnelle und sichere Extraktion aller gängigen Marknägel mit nur einem Set
- Fast and safety extraction of all Intramedular Nails only with one Set
- Быстрота и уверенная экстракция всех применяемых интрамедулярных штифтов с помощью одного комплекта
- Problemloses Ansetzen und Verspannen
- Easy positioning and tightening
- Беспроблемное применение
- Deutliche Verkürzung der OP-Zeit
- Significant reduction of intraoperative extraction time
- Резкое сокращение ОП-времени
- Saubere, übersichtliche Aufbewahrung
- Functional and convenient storage in a specially designed and fully autoclavable container system
- Чистое, наглядное сохранение набора

54-09-55-0000

Universal - Marknagel - Entfernungsset

Universal - Intramedullary Nail - Removal Set

Универсальный набор для удаления интрамедулярных штифтов

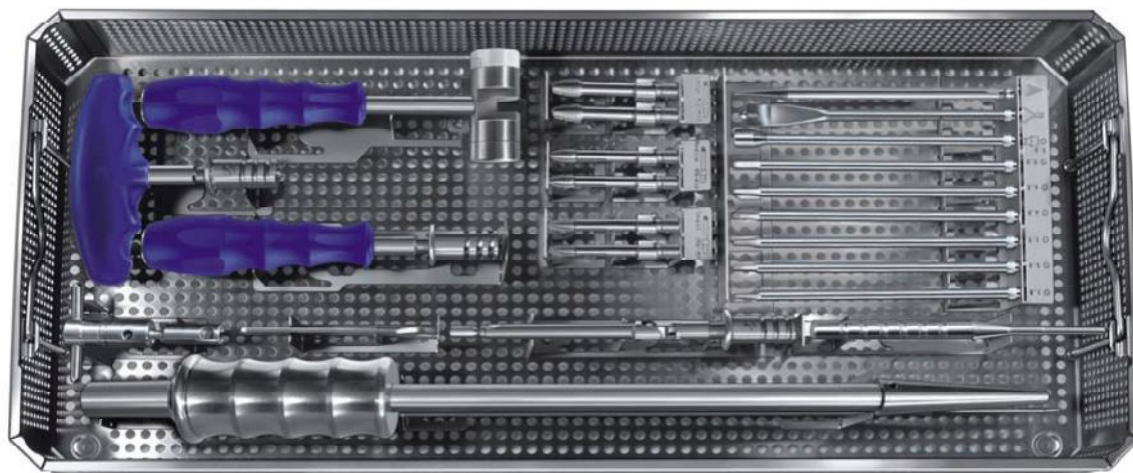



**Universal-Extraktor für Marknägel**  
**Intramedullary Nail Extractor**  
**Универсальный набор для удаления**  
**интрамедулярных штифтов**

Menge /Amount / Кол-во	Inhalt / Index / Содержание	№
1	Siebeinsatz mit Halter STERILISATION TRAY Сетка для стерилизации	54-09-55-0000-30
1	Ausschläger EXTRAKTOR Штифт для экстрактора	27-09-55-1800
2	Spreizereinsatz Gr. 1 von 6-9mm ADAPTER FOR NAIL EXTRACTOR GR1 von 6-9mm Насадка для экстрактора под штифты Ø6-9мм	27-09-55-1800-11
2	Spreizereinsatz Gr. 2 von 9-12mm ADAPTER FOR NAIL EXTRACTOR GR 2 von 9-12mm Насадка для экстрактора под штифты Ø9-12мм	27-09-55-1800-12
2	Spreizereinsatz Gr. 3 von 12-15mm ADAPTER FOR NAIL EXTRACTOR GR 3 von 12-15mm Насадка для экстрактора под штифты Ø12-15мм	27-09-55-1800-13
1	Gabelschlüssel WRENCH Ключ торцевой	27-06-10-1806
1	Klinge SW 2,5 DRIVER HEXAGONAL SW 2,5 Отвертка шестигранная S=2,5мм, под зажим	27-06-25-1803
1	Klinge SW 3,0 DRIVER HEXAGONAL SW 3,0 Отвертка шестигранная S=3,0мм, под зажим	27-06-30-1803
1	Klinge SW 3,5 DRIVER HEXAGONAL SW 3,5 Отвертка шестигранная S=3,5мм, под зажим	27-06-35-1803
1	Klinge SW 4,0 DRIVER HEXAGONAL SW 4,0 Отвертка шестигранная S=4,4мм, под зажим	27-06-40-1803
1	Klinge SW 4,5 DRIVER HEXAGONAL SW 4,5 Отвертка шестигранная S=4,5мм, под зажим	27-06-45-1803
1	Klinge SW 5,0 DRIVER HEXAGONAL SW 5,0 Отвертка шестигранная S=5,0мм, под зажим	27-06-50-1803
1	Schraubendreher mit Führungsbolzen SCREW DRIVER WITH GUIDE PIN Отвертка с направляющим штифтом	27-06-01-1803
1	Steckschlüssel SOCKET WRENCH Ключ рожковый S 9	27-06-02-1803
1	Extraktionsschraubendreher CONICAL EXTRACTION SCREW Коническая экстракционная отвертка	27-06-03-1803
1 k	Durchschlag HEMOSAT Punch Тромбователь костной ткани	27-05-15-1800
1	T-Griff mit Adapter QUICK COUPLING T-HANDLE Зажим Т-образный	27-06-10-1805
1	Griff mit Adapter QUICK COUPLING HANDLE Быстросъемный зажим ручной	27-06-18-1800
1	Kardanverlängerung UNIVERSAL QUICK COUPLING CARDAN JOINT Ключ торцевой корданный под универсальный зажим	27-06-17-1808
1	Hammer MALLET Молоток	27-01-19-1801



27-06-10-1805  
T-Griff mit Adapter  
Quick Couplin T-Handle  
Зажим T-образный



27-06-18-1800  
Griff mit Adapter  
Quick Couplin Handle  
Быстросъемный зажим ручной



27-01-19-1801  
Hammer  
Mallet  
Молоток



27-06-17-1808  
Kardanverlängerung  
Universal Quick Coupling  
Ключ торцевой корданный  
под универсальный зажим



27-06-10-1806  
Gabelschlüssel  
Wrench  
Ключ торцевой



Universal-Extraktor für Marknägel  
 Intramedullary Nail Extractor  
 Универсальный набор для удаления  
 интрамедулярных штифтов



**27-06-25-1803**  
 Klinge SW 2,5  
 Driver Hexagonal SW 2,5  
 Отвертка шестигранная S=2,5мм, под зажим

**27-06-30-1803**  
 Klinge SW 3,0  
 Driver Hexagonal SW 3,0  
 Отвертка шестигранная S=3,0мм, под зажим

**27-06-35-1803**  
 Klinge SW 3,5  
 Driver Hexagonal SW 3,5  
 Отвертка шестигранная S=3,5мм, под зажим

**27-06-40-1803**  
 Klinge SW 4,0  
 Driver Hexagonal SW 4,0  
 Отвертка шестигранная S=4,0мм, под зажим

**27-06-45-1803**  
 Klinge SW 4,5  
 Driver Hexagonal SW 4,5  
 Отвертка шестигранная S=4,5мм, под зажим

**27-06-50-1803**  
 Klinge SW 5,0  
 Driver Hexagonal SW 5,0  
 Отвертка шестигранная S=5,0мм, под зажим



**27-05-15-1800**  
 Durchschlag  
 Punch  
 Тромбователь косной ткани



**27-09-55-1800-11**  
 Spreizereinsatz  
 Gr. 1 von 6-9mm  
 Adapter  
 for nail Extractor Gr 1 6-9mm  
 Насадка для экстрактора  
 под штифты Ø6-9мм



**27-09-55-1800-12**  
 Spreizereinsatz  
 Gr. 2 von 9-12mm  
 Adapter  
 for nail Extractor Gr 2 9-12mm  
 Насадка для экстрактора  
 под штифты Ø9-12мм



**27-09-55-1800-13**  
 Spreizereinsatz  
 Gr. 3 von 12-15mm  
 Adapter  
 for nail Extractor Gr 3 12-15mm  
 Насадка для экстрактора  
 под штифты Ø12-15мм



Universal-Extraktor für Marknägel  
Intramedullary Nail Extractor  
Универсальный набор для удаления  
интрамедулярных штифтов



27-06-02-1803  
Steckschlüssel  
Socket Wrench  
Ключ рожковый S 9



27-06-03-1803  
Extraktionsschraubendreher  
Conical Extraction Screw



27-09-55-1800-31  
Spannstab  
Tension Rod  
Винт-стяжка



27-09-55-1800-32  
Spannstück  
Tension Device  
Натяжное устройство



27-09-55-1800-30  
Hammer  
Extractor  
Экстрактор с молотком



27-09-55-1800  
Ausschläger Intramedullary  
Nail Extraction Hammer  
Штифт для экстрактора



27-01-19-1801-01  
Kunststoffbacken  
Spare Nylon Discs  
Диск пластиковый



27-01-19-1801-03  
Metallbacken  
Spare Steel Discs  
Диск металлический

**EMERGENCY INSTRUMENTS  
TO REMOVE DAMAGED AND BROKEN BONE SCREWS  
АВАРИЙНЫЙ НАБОР ИНСТРУМЕНТОВ  
ДЛЯ УДАЛЕНИЯ ПОВРЕЖДЕННЫХ И СЛОМАННЫХ  
И ВИНТОВ ДЛЯ КОСТЕЙ**







EMERGENCY INSTRUMENTS TO REMOVE DAMAGED AND BROKEN BONE SCREWS  
АВАРИЙНЫЙ НАБОР ИНСТРУМЕНТОВ ДЛЯ УДАЛЕНИЯ ПОВРЕЖДЕННЫХ И СЛОМАННЫХ И ВИНТОВ ДЛЯ КОСТЕЙ

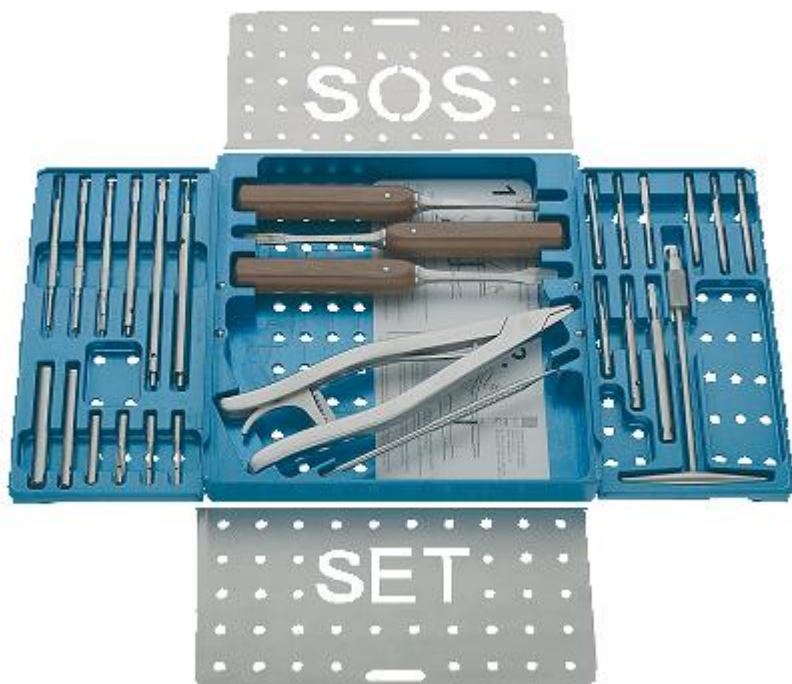

SCREW-EXTRACTION-SET  
27-54-09-25-000  
complete

CONTAINER IID  
300-010  
285 x 280 mm



RECOMMENDED FOR STERILIZATION  
CONTAINER FOR  
27-54-09-25-000  
complete



CONTAINER BOTTOM  
305-100  
285 x 280 x 100 mm

27-54-09-25-0000-31  
TRAY(Empty)

SET - LISTING FOR SET: 27-54-09-25-000 SCREW- EXTRACTION - SET COMPLETE		
REF. - NO.:	PRODUCT - DESCRIPTION:	
27-54-09-25-0000-31	AI-Tray for Screw-Extraction Set-27-54-09-25-000	-1-Pcs.
28-09-15-1603	Conical Extraction Screw for 1.5 / 2.0 mm Screws	-1-Pcs.
28-09-27-1603	Conical Extraction Screw for 2.7 / 3.5 / 4.0 mm Screws	-1-Pcs.
28-09-45-1603	Conical Extraction Screw for 4.5 / 5.0 / 6.5 / 7.0 mm Screws	-1-Pcs.
28-09-15-1601	Extraction Bolt for 1.5 mm Screws	-1-Pcs.
28-09-20-1601	Extraction Bolt for 2.0 mm Screws	-1-Pcs.
28-09-27-1601	Extraction Bolt for 2.7 mm Screws	-1-Pcs.
28-09-35-1601	Extraction Bolt for 3.5 / 4.0 mm Screws	-1-Pcs.
28-09-45-1601	Extraction Bolt for 4.5 mm Screws	-1-Pcs.
28-09-65-1601	Extraction Bolt for 5.0 / 6.5 / 7.0 mm Screws	-1-Pcs.
28-09-15-1602	Hollow Reamer for 1.5 mm Screws	-1-Pcs.
28-09-20-1602	Hollow Reamer for 2.0 mm Screws	-1-Pcs.
28-09-27-1602	Hollow Reamer for 2.7 mm Screws	-1-Pcs.
28-09-35-1602	Hollow Reamer for 3.5 / 4.0 mm Screws	-1-Pcs.
28-09-45-1602	Hollow Reamer for 4.5 mm Screws	-1-Pcs.
28-09-65-1602	Hollow Reamer for 5.0 / 6.5 / 7.0 mm Screws	-1-Pcs.
28-09-15-1602-03	Spare Reamer (Reamer Tube) for Hollow Reamer 1.5 mm (used for 1.5 mm Screws)	-1-Pcs.
28-09-20-1602-03	Spare Reamer (Reamer Tube) for Hollow Reamer 2.0 mm (used for 2.0 mm Screws)	-1-Pcs.
28-09-27-1602-03	Spare Reamer (Reamer Tube) for Hollow Reamer 2.7 mm (used for 2.7 mm Screws)	-1-Pcs.
28-09-35-1602-03	Spare Reamer (Reamer Tube) for Hollow Reamer 3.5 / 4.0 mm (used for 3.5 / 4.0 mm Screws)	-1-Pcs.
28-09-45-1602-03	Spare Reamer (Reamer Tube) for Hollow Reamer 4.5 mm (used for 4.5 mm Screws)	-1-Pcs.
28-09-65-1602-03	Spare Reamer (Reamer Tube) for Hollow Reamer 5.0 / 6.5 / 7.0 mm (used for 5.0 / 6.5 / 7.0 mm Screws)	-1-Pcs.
27-46-16-1800	Sharp Hook, length 155 mm	-1-Pcs.
27-21-03-00-1600	Mini lexer Gouge, 4 mm	-1-Pcs.
27-21-03-00-1601	Mini lexer Gouge, 6 mm	-1-Pcs.
27-21-03-00-1603	Mini lexer Gouge, 10 mm	-1-Pcs.
	Screw Holding Forceps 20.5 cm / 8"	-1-Pcs.
27-06-16-1600	T-Handle, large with AO-Quickcoupling lenght 160 mm	-1-Pcs.
27-54-09-25-000-01	Template for use Broken Screw-Extraction Instruments (Guide Manual for Use)	-1-Pcs.



### 1.

Bitte Gebrauchsanweisung vor dem Sterilisieren aus der Box entfernen.  
Please remove the instruction before sterilisation.

Abgebrochene Schrauben / Broken Screw / Vis Cassées / Viti Spezzate

Freilegung des Schraubenkanals und der abgebrochenen Schraube als Zentrierung für den Hohlfräser, mit Kopfraumfräser oder Spezialmeißel.  
Exposure of the screw hole and the broken screw, which serves to centre the hollow reamer, using a countersink or special chisel.

Préparation de l'orifice et de la vis cassée pour centrer le trépan au moyen de la fraise à chambrer ou du ciseau gouge spécial.

Messa a nudo del canale della vite e della vite spezzata tramite la fresa per sede conica oppure opposto scalpello.

### 2.

Hohlfräser für Schrauben  
Hollow reamer for screws  
Trépan pour vis  
Fresa tubolare per viti  
Ø 1,5mm / Ø 2,0mm / Ø 2,7mm  
Ø 3,5-4,0mm / Ø 4,5mm / Ø 6,5-7,0mm

Zentrierbolzen  
Centering tip  
Guide de centrage  
Perno di centraggio

Mit Hohlfräser Zugang für den Extraktionsbolzen ausfräsen, Schraubenrichtungen beachten. Bei Hohlfräser Zentrierbolzen entfernen wenn der Schraubenstumpf erreicht ist.  
The orientation of the screw is noted. The hole for the extraction bolt is cut using the hollow reamer. The centering tip is removed as soon as it contacts the screw fragment.

Préparer l'approche pour le boulon d'extraction à l'aide du trépan en observant la direction de la direction de la vis. Enlever le guide de centrage au moment où il entre en contact la vis cassée.

Aprve la via per il perno d'estrazione con la fresa tubolare osservando la direzione della vite. Estrarre il perno di centraggio dalla fresa tubolare appena si raggiunge il resto della vite.

### 3.

Extraktionsbolzen für Schrauben  
Extracting bolt for screw  
Boulon d'extraction pour vis  
Perno d'estrazione per viti  
Ø 1,5mm / Ø 2,0mm / Ø 2,7mm  
Ø 3,5-4,0mm / Ø 4,5mm / Ø 6,5-7,0mm

Mit Linksdrehung den Extraktionsbolzen kraftig auf den Schraubenstumpf drücken und herausdrehen.  
The extraction bolt is strongly pressed onto the screw fragment and rotated anticlockwise, thus allowing the fragment to be screwed out.

Extraction de la vis en enfonceant avec force le boulon sur la vis cassée puis en le tournant de droite à gauche.

Premere forte il perno d'estrazione sulla vite spezzata ed estrarla ed estrarla girando a sinistra.

Konische Extraktions Schraube für  
Conical extraction screw  
Vis d'extraction conique  
Vite d'estrazione coniche

tur / for / pour / per Ø 1,5/2,0mm  
tur / for / pour / per Ø 2,7/3,5/4,0mm  
tur / for / pour / per Ø 4,5/6,5/7,0mm

Bei beschädigtem Innensechskant passende konische Extraktionschraube mit Griffstück Pos1 unter Druck und Linksdrehung möglichst senkrecht eindrehen und Schraube entfernen.  
If the hexagonal socket is damaged, insert the fitting conical extraction screw with handle Pos1 as vertically as possible under pressure and left-hand rotation and remove the screw.

En cas d'une empreinte hexagonale intérieure endommagée, visser la vis d'extraction juste avec poignée Pos1 sous pression et rotation inversée aussi verticalement que possible et enlever la vis. In caso che l'esagono incassato è danneggiato, avvitare la vite conica per estrazione adatta con l'impugnatura Pos1 sotto pressione e torsione sinistrorsa il più verticalmente possibile e rimuovere la vite.

### Conical Extraction Screws



28-09-15-1603	Conical Extraction Screw for 1.5 / 2.0 mm Screws
28-09-27-1603	Conical Extraction Screw for 2.7 / 3.5 / 4.0 mm Screws
28-09-45-1603	Conical Extraction Screw for 4.5 / 5.0 / 6.5 / 7.0 mm Screws

### Hollow Reamers complete



28-09-15-1602	Hollow Reamer for 1.5 mm Screws
28-09-20-1602	Hollow Reamer for 2.0 mm Screws
28-09-27-1602	Hollow Reamer for 2.7 mm Screws
28-09-35-1602	Hollow Reamer for 3.5 / 4.0 mm Screws
28-09-45-1602	Hollow Reamer for 4.5 mm Screws
28-09-65-1602	Hollow Reamer for 5.0 / 6.5 / 7.0 mm Screws

### Extraction Bolts

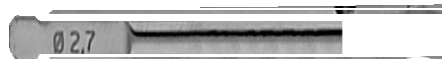

28-09-15-1601	Extraction Bolt for 1.5 mm Screws
28-09-20-1601	Extraction Bolt for 2.0 mm Screws
28-09-27-1601	Extraction Bolt for 2.7 mm Screws



28-09-35-1601	Extraction Bolt for 3.5 / 4.0 mm Screws
28-09-45-1601	Extraction Bolt for 4.5 mm Screws
28-09-65-1601	Extraction Bolt for 5.0 / 6.5 / 7.0 mm Screws



**Hollow Reamers Tube**

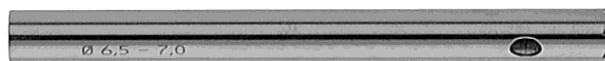

28-09-15-1602-03	Speare Reamer (Reamer Tube) for Hollow Reamer 1.5 mm (used for 1.5 mm Screws)
28-09-20-1602-03	Speare Reamer (Reamer Tube) for Hollow Reamer 2.0 mm (used for 2.0 mm Screws)
28-09-27-1602-03	Speare Reamer (Reamer Tube) for Hollow Reamer 2.7 mm (used for 2.7 mm Screws)
28-09-35-1602-03	Speare Reamer (Reamer Tube) for Hollow Reamer 3.5 / 4.0 mm (used for 3.5 / 4.0 mm Screws)
28-09-45-1602-03	Speare Reamer (Reamer Tube) for Hollow Reamer 4.5 mm (used for 4.5 mm Screws)
28-09-65-1602-03	Speare Reamer (Reamer Tube) for Hollow Reamer 5.0 / 6.5 / 7.0 mm (used for 5.0 / 6.5 / 7.0 mm Screws)

**Hollow Reamers Central Bolt**



28-09-15-1602-02	Central Bolt used with Hollow Reamer for 1.5 mm
28-09-20-1602-02	Central Bolt used with Hollow Reamer for 2.0 mm
28-09-27-1602-02	Central Bolt used with Hollow Reamer for 2.7 mm
28-09-35-1602-02	Central Bolt used with Hollow Reamer for 3.5 / 4.0 mm
28-09-45-1602-02	Central Bolt used with Hollow Reamer for 4.5 mm
28-09-65-1602-02	Central Bolt used with Hollow Reamer for 5.0 / 6.5 / 7.0 mm

**Sharp Hook**



27-46-16-1800
length 155 mm





T-Handle Large with AO-Quickcoupling

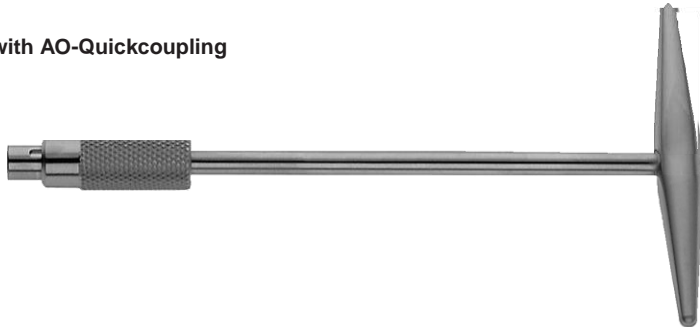

<b>27-06-16-1600</b>
length 160 mm

Screw Holding Forceps



<b>27-01-21-1603</b>
length 20,5 cm / 8"

Mini Lexer Gouge



<b>27-21-03-00-1600</b>
length 4 mm

Mini Lexer Gouge



<b>27-21-03-00-1601</b>
length 6 mm

Mini Lexer Gouge



<b>27-21-03-00-1603</b>



Leicht  
Medizintechnik

**Sterilisation**  
**Sterilization**  
**Stérilisation**  
**Esterilización**  
**Щипцы стерилизационные**







Sterilisierzangen  
Sterilizing Forceps  
Pinces pour instruments stériles  
Pinzas para esterilización  
Щипцы стерилизационные



**DAVIS**  
16,0 cm, 6 $\frac{3}{4}$ " 29-76-160-16  
20,0 cm, 8" 29-76-160-20  
24,0 cm, 9 $\frac{1}{2}$ " 29-76-160-24



**CHEATTLE**  
27,0 cm, 10 $\frac{5}{8}$ "  
29-76-163-27



**ROGGE**  
23,0 cm, 9"  
29-76-164-23



**PYE-SMITH (HARRISON)**  
30,0 cm, 12"  
29-76-166-30



**MAYO**  
14,0 cm, 5 $\frac{1}{2}$ "  
29-76-151-14



**BUNT**  
12,0 cm, 4 $\frac{3}{4}$ "  
29-76-154-12

Schalen  
 Trays  
 Plateaux universaux  
 Bandejas  
 Лотки, подносы



- Ø 30 x 60 mm **29-76-142-01**
- Ø 50 x 100 mm **29-76-142-02**
- Ø 50 x 130 mm **29-76-142-03**
- Ø 50 x 175 mm **29-76-142-04**
- Ø 75 x 100 mm **29-76-142-05**
- Ø 175 x 130 mm **29-76-142-06**
- Ø 175 x 175 mm **29-76-142-07**
- Ø 100 x 175 mm **29-76-142-08**
- Ø 100 x 200 mm **29-76-142-09**



- Ø 40,0 mm **29-76-130-04**
- Ø 60,0 mm **29-76-130-06**
- Ø 80,0 mm **29-76-130-08**
- Ø 100,0 mm **29-76-130-10**
- Ø 120,0 mm **29-76-130-12**
- Ø 150,0 mm **29-76-130-15**



- 170 mm **29-76-140-17**
- 200 mm **29-76-140-20**
- 250 mm **29-76-140-25**
- 275 mm **29-76-140-27**



- 165 x 60 mm **29-76-133-00**
- 175 x 70 mm **29-76-133-10**
- 220 x 80 mm **29-76-133-20**
- 225 x 90 mm **29-76-133-30**
- 240 x110 mm **29-76-133-40**
- 255 x115 mm **29-76-133-50**
- 275 x115 mm **29-76-133-60**
- 290 x125 mm **29-76-133-70**
- 310 x120 mm **29-76-133-80**
- 345 x125 mm **29-76-133-90**
- 380 x130 mm **29-76-133-13**
- 415 x140 mm **29-76-133-14**



165 x 85 x 35 mm	<b>29-76-200-01</b>
200 x 100 x 35 mm	<b>29-76-200-02</b>
200 x 100 x 50 mm	<b>29-76-200-03</b>
230 x 130 x 50 mm	<b>29-76-200-04</b>
260 x 150 x 50 mm	<b>29-76-200-05</b>
270 x 235 x 50 mm	<b>29-76-200-06</b>
300 x 200 x 50 mm	<b>29-76-200-07</b>
325 x 275 x 50 mm	<b>29-76-200-08</b>
350 x 250 x 150 mm	<b>29-76-200-09</b>
420 x 130 x 100 mm	<b>29-76-200-10</b>
430 x 200 x 120 mm	<b>29-76-200-20</b>
450 x 190 x 80 mm	<b>29-76-200-19</b>



50 ccm  
**29-76-310-50**



25 ccm  
**29-76-310-25**



**29-76-300-01**  
Ø 62 x 13 mm

Innendose allein  
Interior box only  
boite seul  
Caja interior, suelta  
Только внутренняя коробка

**29-76-300-00**  
Ø 65 x 17 mm

Außen- und Innendose  
Exterior and interior box  
extérieur et intérieur boîte  
Caja exterior e interior  
Внешняя и внутренняя коробки



Leicht  
Medizintechnik

**Container  
Container  
Контейнер**









Boden ungelocht  
Bottom non perforated  
Дно неперфорированное

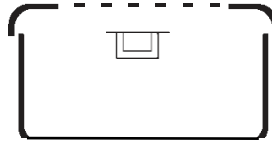

L(mm)	B(mm)	H(mm)						
580	280	100	29-110-150	29-120-150	29-130-150	29-140-150	29-150-150	29-160-150
580	280	135	29-110-135	29-120-135	29-130-135	29-140-135	29-150-135	29-160-135
580	280	150	29-110-150	29-120-150	29-130-150	29-140-150	29-150-150	29-160-150
580	280	200	29-110-200	29-120-200	29-130-200	29-140-200	29-150-200	29-160-200
580	280	260	29-110-260	29-120-260	29-130-260	29-140-260	29-150-260	29-160-260

Boden gelocht  
Bottom perforated  
Дно перфорированное

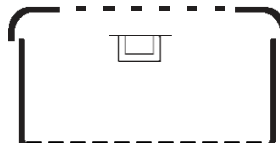

L(mm)	B(mm)	H(mm)						
580	280	100	29-111-100	29-121-100	29-131-100	29-141-100	29-151-100	29-161-100
580	280	135	29-111-135	29-121-135	29-131-135	29-141-135	29-151-135	29-161-135
580	280	150	29-111-150	29-121-150	29-131-150	29-141-150	29-151-150	29-161-150
580	280	200	29-111-200	29-121-200	29-131-200	29-141-200	29-151-200	29-161-200
580	280	260	29-111-260	29-121-260	29-131-260	29-141-260	29-151-260	29-161-260

Container  
Container  
Контейнер



Boden ungelocht  
Bottom non perforated  
Дно неперфорированное

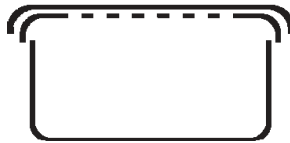

L(mm)	B(mm)	H(mm)						
580	280	100	29-112-100	29-122-100	29-132-100	29-142-100	29-152-100	29-162-100
580	280	135	29-112-135	29-122-135	29-132-135	29-142-135	29-152-135	29-162-135
580	280	150	29-112-150	29-122-150	29-132-150	29-142-150	29-152-150	29-162-150
580	280	200	29-112-200	29-122-200	29-132-200	29-142-200	29-152-200	29-162-200
580	280	260	29-112-260	29-122-260	29-132-260	29-142-260	29-152-260	29-162-260

Boden gelocht  
Bottom perforated  
Дно перфорированное

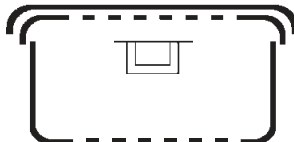

L(mm)	B(mm)	H(mm)						
580	280	100	29-113-100	29-123-100	29-133-100	29-143-100	29-153-100	29-163-100
580	280	135	29-113-135	29-123-135	29-133-135	29-143-135	29-153-135	29-163-135
580	280	150	29-113-150	29-123-150	29-133-150	29-143-150	29-153-150	29-163-150
580	280	200	29-113-200	29-123-200	29-133-200	29-143-200	29-153-200	29-163-200
580	280	260	29-113-260	29-123-260	29-133-260	29-143-260	29-153-260	29-163-260



Boden ungelocht  
Bottom non perforated  
Дно неперфорированное

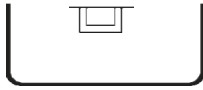

Boden gelocht  
Bottom perforated  
Дно перфорированное

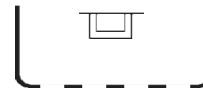

außen / outside / снаружи

<b>29-105-100</b>	580 x 280 x 100 mm
<b>29-105-135</b>	580 x 280 x 135 mm
<b>29-105-150</b>	580 x 280 x 150 mm
<b>29-105-200</b>	580 x 280 x 200 mm
<b>29-105-260</b>	580 x 280 x 260 mm

innen / inside / внутри

<b>29-106-100</b>	550 x 262 x 84 mm
<b>29-106-135</b>	550 x 262 x 117 mm
<b>29-106-150</b>	550 x 262 x 132 mm
<b>29-106-200</b>	550 x 262 x 182 mm
<b>29-106-260</b>	550 x 262 x 244 mm

Deckel gelocht  
Lid perforated  
Крышка перфорированная



L(mm)	B(mm)	29-100-010	29-100-020	29-100-030	29-100-040	29-100-050	29-100-060
580	280						

Sicherheitsdeckel  
Safety Lid  
Крышка защитная

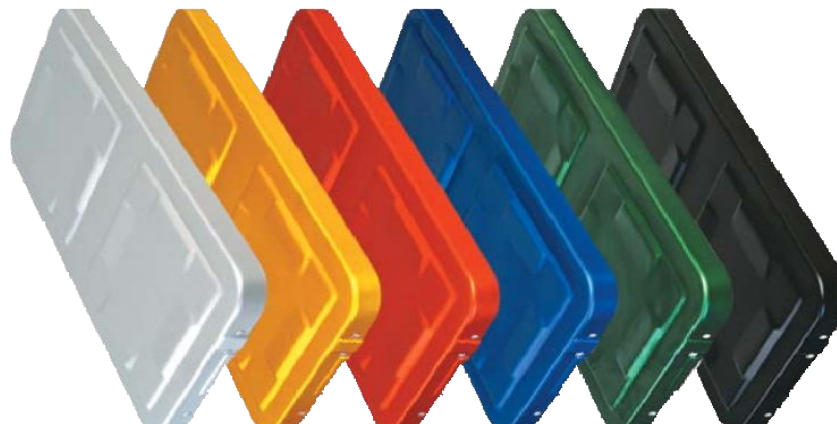

L(mm)	B(mm)	29-103-010	29-103-020	29-103-030	29-103-040	29-103-050	29-103-060
580	280						

Container  
Container  
Контейнер



Siebkorb/ Wire Basket / Сетка

**29-190-030** 485 x 255 x 30 mm  
**29-190-050** 485 x 255 x 50 mm  
**29-190-070** 485 x 255 x 70 mm  
**29-190-100** 485 x 255 x 100 mm

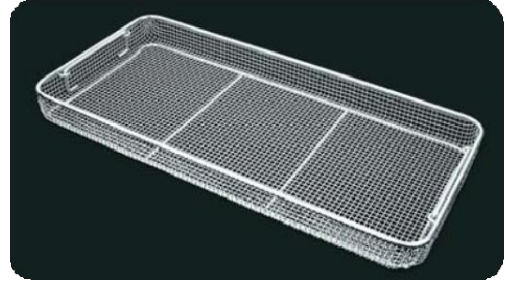

Siebkorb/ Wire Basket / Сетка

**29-191-030** 540 x 255 x 30 mm  
**29-191-050** 540 x 255 x 50 mm  
**29-191-070** 540 x 255 x 70 mm  
**29-191-100** 540 x 255 x 100 mm

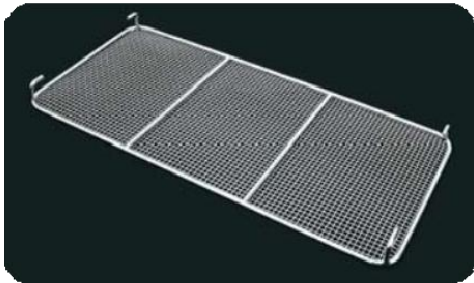

Zwischenboden / Wire Base / Сетка  
**29-193-000** 545 x 255 x 30 mm

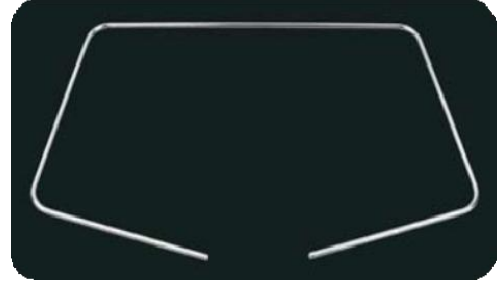

Spannrahmen / Drape Retainer / Рамка  
**29-195-000** 545 x 255 mm



Einschlagtuch / Drape / Салфетка

**29-095-070** 130 x 60 cm  
**29-095-080** 140 x 100 cm  
**29-095-090** 185 x 45 cm  
**29-095-100** 185 x 60 cm



Boden ungelocht  
Bottom non perforated  
Дно неперфорированное

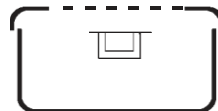

L(mm)	B(mm)	H(mm)						
465	280	100	29-210-100	29-220-100	29-230-100	29-240-100	29-250-100	29-260-100
465	280	135	29-210-135	29-220-135	29-230-135	29-240-135	29-250-135	29-260-135
465	280	150	29-210-150	29-220-150	29-230-150	29-240-150	29-250-150	29-260-150

Boden gelocht  
Bottom perforated  
Дно перфорированное

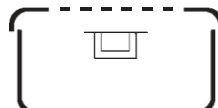

L(mm)	B(mm)	H(mm)						
465	280	100	29-211-100	29-221-100	29-231-100	29-241-100	29-251-100	29-261-100
465	280	135	29-211-135	29-221-135	29-231-135	29-241-135	29-251-135	29-261-135
465	280	150	29-211-150	29-221-150	29-231-150	29-241-150	29-251-150	29-261-150

Container  
Container  
Контейнер



Boden ungelocht  
Bottom non perforated  
Дно неперфорированное

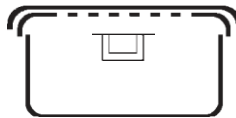

L(mm)	B(mm)	H(mm)						
465	280	100	29-212-100	29-222-100	29-232-100	29-242-100	29-252-100	29-262-100
465	280	135	29-212-135	29-222-135	29-232-135	29-242-135	29-252-135	29-262-135
465	280	150	29-212-150	29-222-150	29-232-150	29-242-150	29-252-150	29-262-150

Boden ungelocht  
Bottom non perforated  
Дно перфорированное

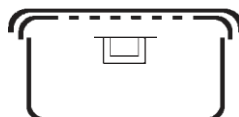

L(mm)	B(mm)	H(mm)						
465	280	100	29-213-100	29-223-100	29-233-100	29-243-100	29-253-100	29-263-100
465	280	135	29-213-135	29-223-135	29-233-135	29-243-135	29-253-135	29-263-135
465	280	150	29-213-150	29-223-150	29-233-150	29-243-150	29-253-150	29-263-150



Boden ungelocht  
Bottom non perforated  
Дно неперфорированное

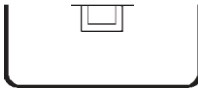

Boden gelocht  
Bottom perforated  
Дно перфорированное

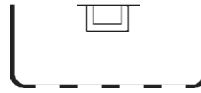

**29-205-100**

**29-205-135**

**29-205-150**

außen / outside / снаружи

465 x 280 x 100 mm

465 x 280 x 135 mm

465 x 280 x 150 mm

innen / inside / внутри

425 x 262 x 85 mm

425 x 262 x 121 mm

425 x 262 x 135 mm

**29-206-100**

**29-206-135**

**29-206-150**

Deckel gelocht  
Lid perforated  
Крышка перфорированная



L(mm)	B(mm)	29-200-010	29-200-020	29-200-030	29-200-040	29-200-050	29-200-060
465	280						

Sicherheitsdeckel  
Safety Lid  
Крышка защитная

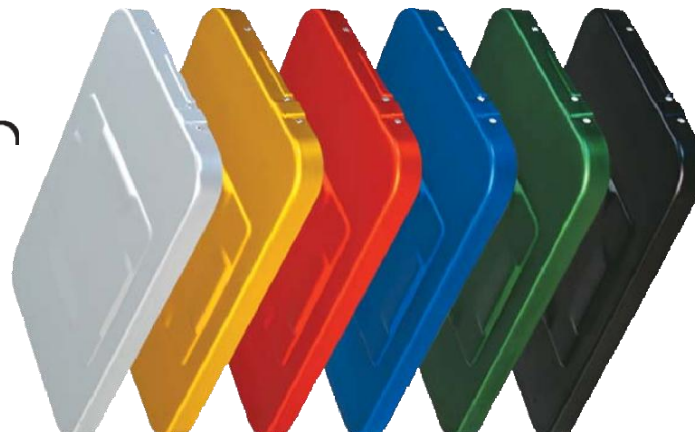

L(mm)	B(mm)	29-203-010	29-203-020	29-203-030	29-203-040	29-203-050	29-203-060
465	280						



Container  
Container  
Контейнер

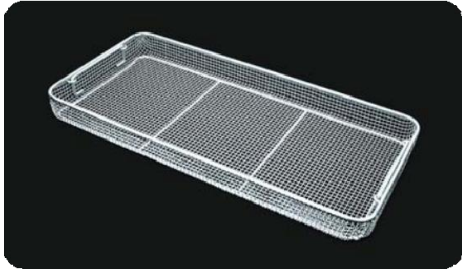

Drahtsiebkorb / Wire Basket / Сетка

**29-290-030** 405 x 255 x 30 mm

**29-290-050** 405 x 255 x 50 mm

**29-290-070** 405 x 255 x 70 mm

**29-290-100** 405 x 255 x 100 mm

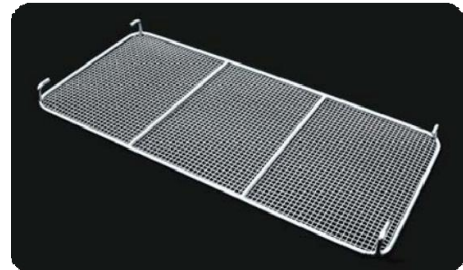

Zwischenboden / Wire Base / Сетка

**29-293-030** 405 x 255 x 30 mm



Spannrahmen / Drape Retainer / Рамка

**29-295-000** 405 x 255 mm



Einschlagtuch / Drape / Салфетка

**29-095-080** 140 x 100 cm



Boden ungelocht  
Bottom non perforated  
Дно неперфорированное

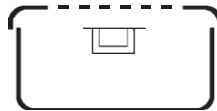

L(mm)	B(mm)	H(mm)						
285	280	100	29-310-100	29-320-100	29-330-100	29-340-100	29-350-100	29-360-100
285	280	135	29-310-135	29-320-135	29-330-135	29-340-135	29-350-135	29-360-135
285	280	150	29-310-150	29-320-150	29-330-150	29-340-150	29-350-150	29-360-150
285	280	200	29-310-200	29-320-200	29-330-200	29-340-200	29-350-200	29-360-200
285	280	260	29-310-260	29-320-260	29-330-260	29-340-260	29-350-260	29-360-260

Boden gelocht  
Bottom perforated  
Дно перфорированное

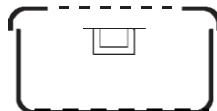

Container  
Container  
Контейнер



Boden ungelocht  
Bottom non perforated  
Дно перфорированное

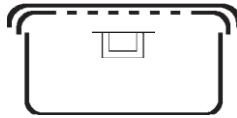

L(mm)	B(mm)	H(mm)	29-312-100	29-322-100	29-332-100	29-342-100	29-352-100	29-362-100
285	280	100	29-312-135	29-322-135	29-332-135	29-342-135	29-352-135	29-362-135
285	280	150	29-312-150	29-322-150	29-332-150	29-342-150	29-352-150	29-362-150
285	280	200	29-312-200	29-322-200	29-332-200	29-342-200	29-352-200	29-362-200
285	280	260	29-312-260	29-322-260	29-332-260	29-342-260	29-352-260	29-362-260

Boden gelocht  
Bottom perforated  
Дно перфорированное

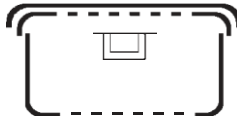



Boden ungelocht  
Bottom non perforated  
Дно неперфорированное

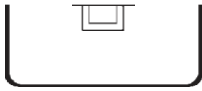

Boden gelocht  
Bottom perforated  
Дно перфорированное

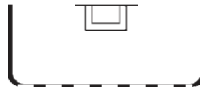

	außen / outside / снаружи	innen / inside / внутри	
<b>29-305-100</b>	285 x 280 x 100 mm	262 x 262 x 82 mm	<b>29-306-100</b>
<b>29-305-135</b>	285 x 280 x 135 mm	262 x 262 x 120 mm	<b>29-306-135</b>
<b>29-305-150</b>	285 x 280 x 150 mm	262 x 262 x 135 mm	<b>29-306-150</b>
<b>29-305-200</b>	285 x 280 x 200 mm	262 x 262 x 185 mm	<b>29-306-200</b>
<b>29-305-260</b>	285 x 280 x 260 mm	262 x 262 x 240 mm	<b>29-306-260</b>

Deckel gelocht  
Lid perforated  
Крышка перфорированная



L(mm)	B(mm)						
285	280	29-300-010	29-300-020	29-300-030	29-300-040	29-300-050	29-300-060

Sicherheitsdeckel  
Safety Lid  
Крышка защитная



L(mm)	B(mm)						
285	280	29-303-010	29-303-020	29-303-030	29-303-040	29-303-050	29-303-060

Container  
Container  
Контейнер

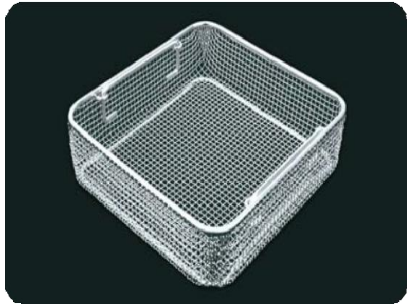

Drahtsiebkorb / Wire Basket / Сетка  
**29-390-030** 255 x 245 x 30 mm  
**29-390-050** 255 x 245 x 50 mm  
**29-390-070** 255 x 245 x 70 mm  
**29-390-100** 255 x 245 x 100 mm

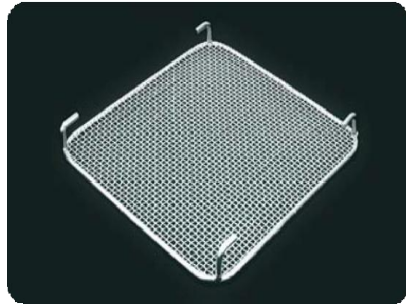

Zwischenboden / Wire Base / Сетка  
**29-393-000** 258 x 258 x 30 mm

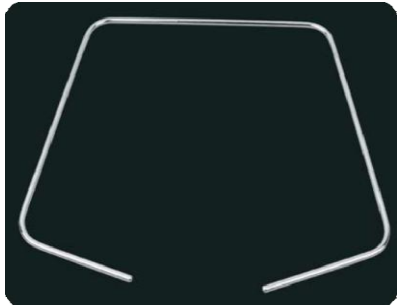

Spannrahmen / Drape Retainer / Рамка  
**29-395-000** 255 x 255 mm



Einschlagtuch / Drape / Салфетка  
**29-095-040** 90 x 60 cm  
**29-095-050** 90 x 80 cm  
**29-095-060** 130 x 45 cm  
**29-095-070** 130 x 60 cm



Boden ungelocht  
Bottom non perforated  
Дно неперфорированное

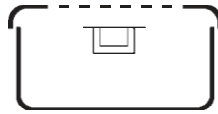

L(mm)	B(mm)	H(mm)						
600	400	120	29-110-062	29-120-062	29-130-062	29-140-062	29-150-062	29-160-062
600	400	180	29-110-068	29-120-068	29-130-068	29-140-068	29-150-068	29-160-068

Boden gelocht  
Bottom perforated  
Дно перфорированное

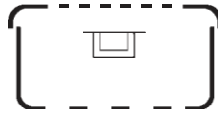

L(mm)	B(mm)	H(mm)						
600	400	120	29-111-062	29-121-062	29-131-062	29-141-062	29-151-062	29-161-062
600	400	180	29-111-068	29-121-068	29-131-068	29-141-068	29-151-068	29-161-068



Drahtsiebkorb / Wire Basket / Сетка  
29-190-055 470 x 337 x 51 mm

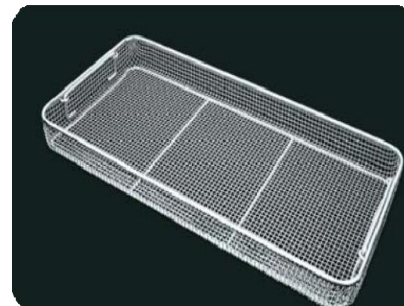

Drahtsiebkorb / Wire Basket / Сетка  
29-191-060 533 x 337 x 101 mm

Container  
Container  
Контейнер

Boden ungelocht  
Bottom non perforated  
Дно неперфорированное

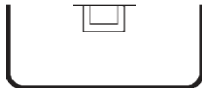

**29-105-062**  
**29-105-068**

außen / outside / снаружи  
600 x 400 x 120 mm  
600 x 400 x 180 mm

Boden gelocht  
Bottom perforated  
Дно перфорированное

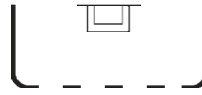

**29-106-062**  
**29-106-068**

innen / inside / внутри  
550 x 350 x 100 mm  
550 x 350 x 160 mm

Deckel gelocht  
Lid perforated  
Крышка перфорированная



L(mm)	B(mm)	Color	Code
600	400	Grey	29-100-051
600	400	Yellow	29-100-052
600	400	Red	29-100-053
600	400	Blue	29-100-054
600	400	Green	29-100-055
600	400	Black	29-100-056





Boden ungelocht  
Bottom non perforated  
Дно неперфорированное

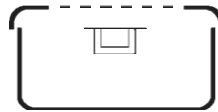

L(mm)	B(mm)	H(mm)						
285	280	55	29-310-050	29-320-050	29-330-050	29-340-050	29-350-050	29-360-050
285	280	180	29-310-080	29-320-080	29-330-080	29-340-080	29-350-080	29-360-080

Boden gelocht  
Bottom perforated  
Дно перфорированное

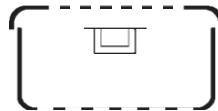

L(mm)	B(mm)	H(mm)						
285	280	180	29-311-080	29-321-080	29-331-080	29-341-080	29-351-080	29-361-080

Boden ungelocht  
Bottom non perforated  
Дно неперфорированное

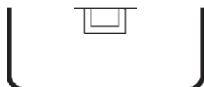

außen / outside / снаружи  
**29-305-050** 285 x 280 x 55 mm  
**29-305-080** 285 x 280 x 85 mm

innen / inside / внутри  
270 x 270 x 33 mm  
270 x 270 x 64 mm

Boden gelocht  
Bottom perforated  
Дно перфорированное

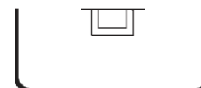

außen / outside / снаружи      innen / inside / внутри  
**29-306-080**      285 x 280 x 85 mm      270 x 270 x 64 mm



Container  
Container  
Контейнер

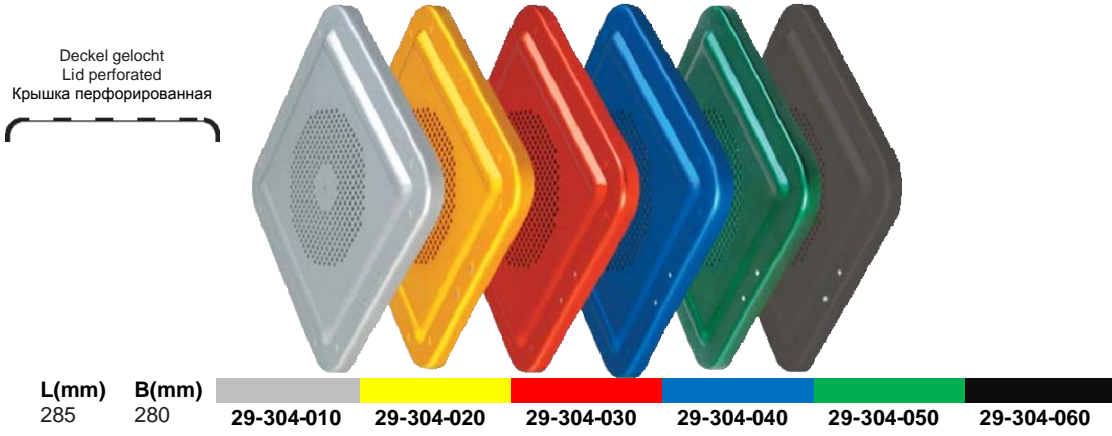

Drahtsiebkorb / Wire Basket / Сетка  
**29-390-030** 255 x 245 x 30 mm  
**29-390-050** 255 x 245 x 50 mm

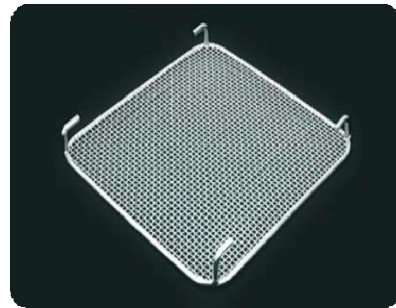

Zwischenboden / Wire Base / Сетка  
**29-393-000** 245 x 255 x 30 mm



Silikonmatte / Silicone Mat / Силиконовый коврик  
**29-851-000** 245 x 245 mm



Einschlagtuch / Drape / Салфетка  
**29-095-040** 90 x 60 cm  
**29-095-050** 90 x 80 cm



Spannrahmen / Drape Retainer / Рамка  
**29-395-000** 255 x 255 mm



Boden ungelocht  
Bottom non perforated  
Дно неперфорированное

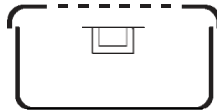

L(mm)	B(mm)	H(mm)	29-410-040	29-420-040	29-430-040	29-440-040	29-450-040	29-460-040
300	140	40						
300	140	70	29-410-070	29-420-070	29-430-070	29-440-070	29-450-070	29-460-070
300	140	100	29-410-100	29-420-100	29-430-100	29-440-100	29-450-100	29-460-100

Boden gelocht  
Bottom perforated  
Дно перфорированное

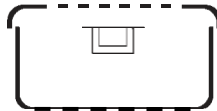

L(mm)	B(mm)	H(mm)	29-411-040	29-421-040	29-431-040	29-441-040	29-451-040	29-461-040
300	140	40						
300	140	70	29-411-070	29-421-070	29-431-070	29-441-070	29-451-070	29-461-070
300	140	100	29-411-100	29-421-100	29-431-100	29-441-100	29-451-100	29-461-100

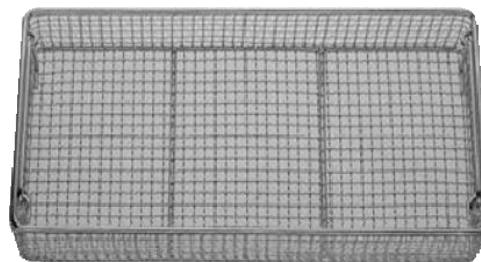

Mini Siebkorb / Mini Wire basket / Мини-сетка  
29-490-050 265 x 120 x 45 mm

**Container  
Container  
Контейнер**

Boden ungelocht  
Bottom non perforated  
Дно неперфорированное

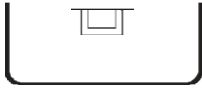

Boden gelocht  
Bottom perforated  
Дно перфорированное

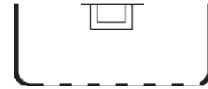

außen / outside / снаружи

<b>29-405-040</b>	300 x 140 x 40 mm
<b>29-405-070</b>	300 x 140 x 70 mm
<b>29-405-100</b>	300 x 140 x 100 mm

innen / inside / внутри

<b>29-406-040</b>	280 x 130 x 27 mm
<b>29-406-070</b>	280 x 130 x 55 mm
<b>29-406-100</b>	280 x 130 x 84 mm

Deckel gelocht  
Lid perforated  
Крышка перфорированная



L(mm)	B(mm)	29-400-010	29-400-020	29-400-030	29-400-040	29-400-050	29-400-060
300	140						



Spannrahmen / Drape Retainer / Памка  
**29-495-000** 280 x 125 mm



Silikonmatte / Silicone Mat / Силиконовый коврик  
**29-850-000** 270 x 125 mm



Einschlagtuch / Drape / Салфетка  
**29-095-010** 60 x 40 cm



Boden gelocht  
Bottom perforated  
Дно перфорированное

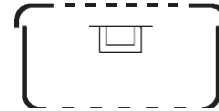

L(mm)	B(mm)	H(mm)	
310	190	40	<b>29-510-040</b>
310	190	65	<b>29-510-060</b>
310	190	130	<b>29-510-130</b>



Boden gelocht  
Bottom perforated  
Дно перфорированное

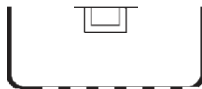

Deckel gelocht  
Lid perforated  
Крышка перфорированная



	außen / outside / снаружи
<b>29-506-040</b>	310 x 190 x 40 mm
<b>29-506-060</b>	310 x 190 x 65 mm
<b>29-506-130</b>	310 x 190 x 130 mm

	Deckel / Lid / Крышка
<b>29-500-010</b>	310 x 190 mm
<b>29-500-020</b>	310 x 190 mm



Spannrahmen / Drape Retainer / Рамка  
**29-595-000** 310 x 190 mm



Einschlagtuch / Drape / Салфетка  
**29-095-010** 60 x 40 cm  
**29-095-020** 65 x 65 cm  
**29-095-030** 85 x 85 cm

**Implant Container**  
**Implantat Container**  
**Контейнер для имплантатов**

Deckel gelocht / Boden ungelocht (kein Filter)  
 Lid perforated / Bottom perforated (non Filter)  
 Крышка перфорированная / Дно неперфорированное (без фильтра)



L(mm)	B(mm)	H(mm)						
500	155	75	29-612-070	29-622-070	29-632-070	29-642-070	29-652-070	29-662-070



L(mm)	B(mm)	H(mm)						
500	155	75	29-610-060	29-620-060	29-630-060	29-640-060	29-650-060	29-660-060



Deckel gelocht / Boden gelocht (kein Filter)  
Lid perforated / Bottom perforated (non Filter)  
Крышка перфорированная / Дно перфорированное (без фильтра)



L(mm)	B(mm)	H(mm)	
250	60	50	<b>29-600-010</b>
450	70	70	<b>29-600-020</b>

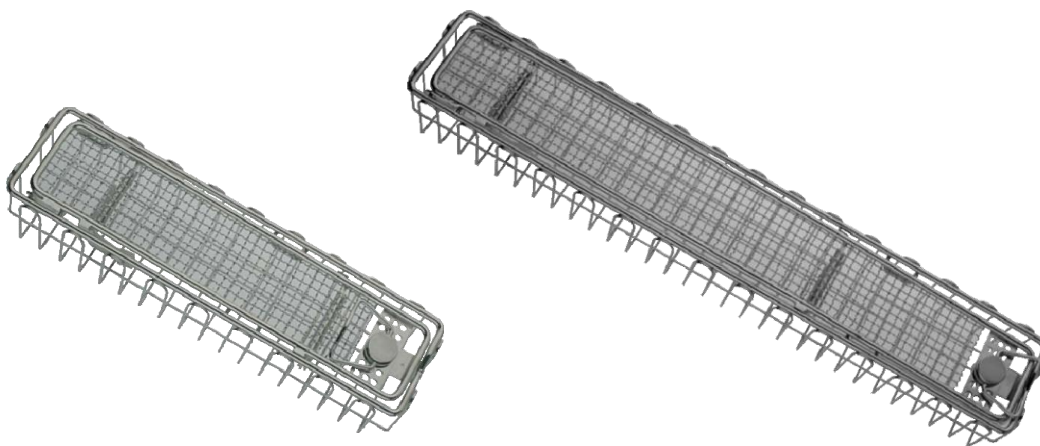

Siebkorb für 1 Endoskop mit Fixierungselement  
Tray for 1 scope with fixation  
Сетка для 1 эндоскопа с фиксирующим элементом

**29-600-030**      290 x 80 x 55 mm

Siebkorb für 1 Endoskop mit Fixierungselement  
Tray for 1 scope with fixation  
Сетка для 1 эндоскопа с фиксирующим элементом

**29-600-040**      465 x 80 x 55 mm



Entsorgungscontainer  
Removal Container  
Контейнер для использованных материалов

Deckel und Boden ungelocht  
Lid and Bottom non perforated  
Крышка и дно неперфорированные



L(mm)	B(mm)	H(mm)	29-315-100	29-325-100	29-335-100	29-345-100	29-355-100	29-365-100
285	280	100						
285	280	150						
580	280	150						

Boden ungelocht  
Bottom non perforated  
Дно неперфорированное

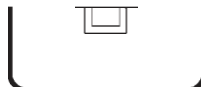

**29-105-150** 580 x 280 x 150 mm



**29-305-100** 285 x 280 x 150 mm  
**29-305-150** 285 x 280 x 150 mm



Deckel ungelocht  
Lid non perforated  
Крышка перфорированная



L(mm)	B(mm)	Color	Part Number
285	280	Yellow	29-302-010
285	280	Orange	29-302-020
285	280	Blue	29-302-030
285	280	Green	29-302-040
285	280	Black	29-302-050
285	280	Silver	29-302-060

Deckel ungelocht  
Lid non perforated  
Крышка перфорированная



L(mm)	B(mm)	Color	Part Number
580	280	Yellow	29-102-010
580	280	Orange	29-102-020
580	280	Blue	29-102-030
580	280	Green	29-102-040
580	280	Black	29-102-050
580	280	Silver	29-102-060



Container für Bürsten  
Brush Container  
Контейнер для щеток



L(mm)	B(mm)	H(mm)	
240	275	70	<b>29-882-000</b>

Edelstahl-Container für 20 Bürsten  
Container Stainless steel for 20 brushes  
Контейнер из нержавеющей стали для 20 щеток

L(mm)	B(mm)	H(mm)					
240	275	70	<b>29-880-100</b>	<b>29-880-110</b>	<b>29-880-120</b>	<b>29-880-130</b>	<b>29-880-140</b>

Aluminium-Container für 20 Bürsten  
Aluminium Container for 20 brushes  
Контейнер алюминиевый для 20 щеток



Filter, Indikatoren und Kennzeichnung  
Filters, Indicators and Labels  
Фильтры, индикаторы, маркировка



**29-800-000**  
Einmaliger Papier-Filter  
Disposable Paper Filter  
Одноразовый бумажный  
фильтр



**29-800-010**  
Textilfilter  
Textilfilter  
Текстиль-фильтр



**29-802-000**  
Einmaliger Papier-Filter  
Disposable Paper Filter  
Одноразовый бумажный  
фильтр



**29-802-010**  
Textilfilter  
Single textil  
Одноразовый текстиль-  
фильтр



**29-810-000**  
Indikatorschilder  
Paper label with indicator  
Этикетка индикатора

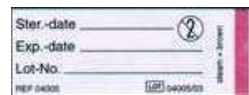

**29-812-000**  
Indikatorschilder  
Paper label with indicator  
Этикетка индикатор



Filterhalterung / filter tray / держатель фильтра  
**29-809-000** - für Papier-Filter / for Paper-Filter /  
для бумажного фильтра  
**29-809-010** - für Textilfilter-Filter / for Textile  
Filter / для текстиль-фильтра



**29-801-000**  
Spender für Einmalfilter  
Filter Dispenser  
Диспенсер



**29-819-000**  
Sicherheitsiegel  
Plastic Security Seal  
Пломба



**29-829-000**  
Sortiermagazin für Kennzeichnungsschilder  
Dispenser for identification labels  
Диспенсер для этикеток



- 29-820-010**
- 29-820-020**
- 29-820-030**
- 29-820-040**
- 29-820-050**
- 29-820-060**
- 29-820-070**
- 29-820-080**

Kennzeichnungsschilder mit oder ohne Beschriftung,  
max- 16 Buchstaben  
Coloured identification labels- Printed to your  
specification, max-16 letters  
Этикетки с или без маркировки, не более 16 символов

**Silikonmatten und Fixierklemmen**  
**Silicon mats and fixation clamps**  
**Силиконовые коврики и фиксирующие зажимы**



**29-850-000** 270 x 125 mm



**29-851-000** 245 x 245 mm



- 29-852-000** 220 x 230 mm
- 29-852-100** 380 x 230 mm
- 29-852-200** 440 x 230 mm
- 29-852-300** 520 x 230 mm

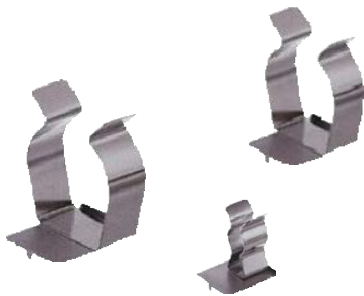

∅	L(mm)	B(mm)	H(mm)	
∅ 7 - 12 mm	24	28	25	<b>29-849-200</b>
∅ 12 - 16 mm	24	28	29	<b>29-849-210</b>
∅ 16 - 26 mm	24	28	31	<b>29-849-220</b>
∅ 26 - 36 mm	24	28	40	<b>29-849-230</b>
∅ 36 - 45 mm	24	28	44	<b>29-849-240</b>



**29-849-000**  
50 x 20 x 12 mm



**29-849-010**  
65 x 20 x 20 mm





**29-830-010**  
Haltestift für Trennbleche  
Holding Pin for Partition Sheets  
ПИН- для крепления  
Разделительных пластин



**29-830-000**  
Haltestifte für Instrumente  
Holding Pin for Wire Baskets  
ПИН для крепления  
инструментов

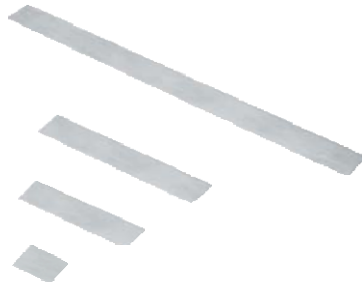

Trennbleche / Sheets / Разделительные пластины  
**29-831-050** 50 x 20 mm  
**29-831-130** 130 x 20 mm  
**29-831-220** 225 x 20 mm  
**29-831-460** 460 x 20 mm

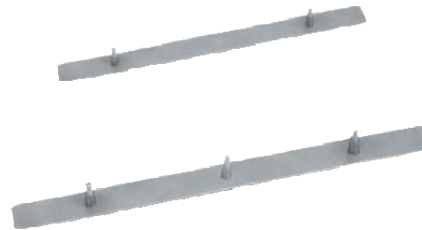

Schiene für Gleitschieber  
Sliding Rails with Securing Screws  
Шины для крепежных винтов  
**29-841-000** 230 mm  
**29-841-010** 470 mm



**29-842-000** 230 mm  
**29-842-010** 470 mm  
Anschlagrahmen  
Limiting Bar with Securing Screws  
Рамка



**29-840-000**  
Gleitschieber, für Benutzung  
mit **29-841-000**  
Divider, to be used  
with **29-841-000**  
Деталь для использования  
с **29-841-000**



**29-845-000**  
Spiralfeder Haltevorrichtung  
Spiral Holding  
Пружинный держатель



**29-847-000**  
Doppel-Spiralfeder Haltevorrichtung  
Double Spiral Holding  
Двойной пружинный держатель

Dauerfilter  
Permanent Filter  
Многоразовые фильтры



**29-800-020**  
Verwendungsdauer 1200 Sterilisationszyklen  
Life for 1200 Sterilization cycles  
Фильтр рассчитан на 1200 стерилизационных циклов

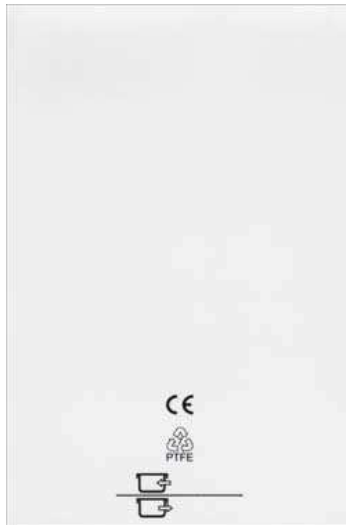

**29-804-020**  
Verwendungsdauer 1200 Sterilisationszyklen  
Life for 1200 Sterilization cycles  
Фильтр рассчитан на 1200 стерилизационных циклов

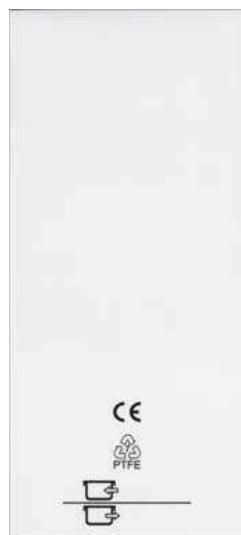

**29-802-020**  
Verwendungsdauer 1200 Sterilisationszyklen  
Life for 1200 Sterilization cycles  
Фильтр рассчитан на 1200 стерилизационных циклов

**Siebkörbe** aus Edelstahl mit oder ohne Deckel  
**Baskets** from stainless Steel with or without lid  
**Сетка** из нержавеющей стали без или с крышкой

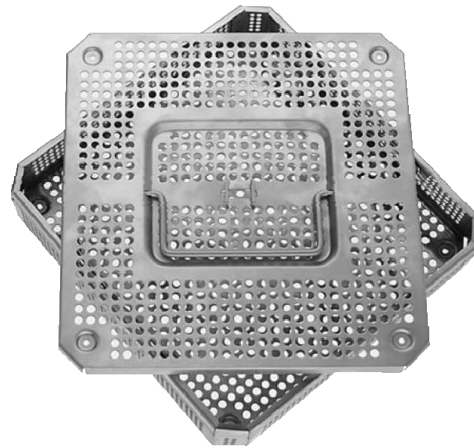

Siebkorb aus Edelstahlblech / Baskets from stainless Steel /  
 Сетка из нержавеющей стали

<b>29.1-590-050</b>	267 x 173 x 34 mm
<b>29.1-490-050</b>	271 x 117 x 50 mm
<b>29.1-390-030</b>	243 x 253 x 30 mm
<b>29.1-390-050</b>	243 x 253 x 50 mm
<b>29.1-390-070</b>	243 x 253 x 70 mm
<b>29.1-390-100</b>	243 x 253 x 100 mm
<b>29.1-290-030</b>	405 x 253 x 30 mm
<b>29.1-290-050</b>	405 x 253 x 50 mm
<b>29.1-290-070</b>	405 x 253 x 70 mm
<b>29.1-290-100</b>	405 x 253 x 100 mm
<b>29.1-190-030</b>	485 x 253 x 30 mm
<b>29.1-190-050</b>	485 x 253 x 50 mm
<b>29.1-190-070</b>	485 x 253 x 70 mm
<b>29.1-190-100</b>	485 x 253 x 100 mm
<b>29.1-191-030</b>	540 x 253 x 30 mm
<b>29.1-191-050</b>	540 x 253 x 50 mm
<b>29.1-191-070</b>	540 x 253 x 70 mm
<b>29.1-191-100</b>	540 x 253 x 100 mm

Deckel zu Siebkorb mit Verschuß / Lid for Baskets with lock  
 Крышка для сетки, с замком

<b>29.1-590-000</b>	265 x 175 mm
<b>29.1-490-000</b>	271 x 117 mm
<b>29.1-390-000</b>	243 x 253 mm
<b>29.1-290-000</b>	405 x 253 mm
<b>29.1-190-000</b>	485 x 253 mm
<b>29.1-191-000</b>	540 x 253 mm

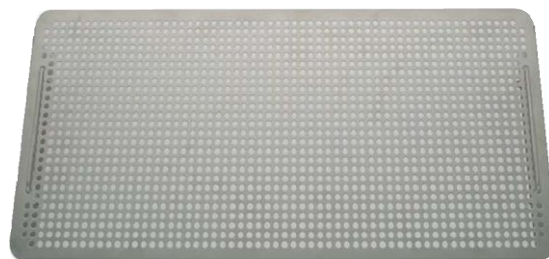

Zwischenboden für Edelstahlsiebkorb, für alle Siebkorbgrößen lieferbar  
 Wire base for baskets, available for all sizes  
 Разделяющая сетка для всех размеров, в наличии

**Silikonlagerungen**  
**Silicone fixation**  
**Силиконовые фиксаторы**

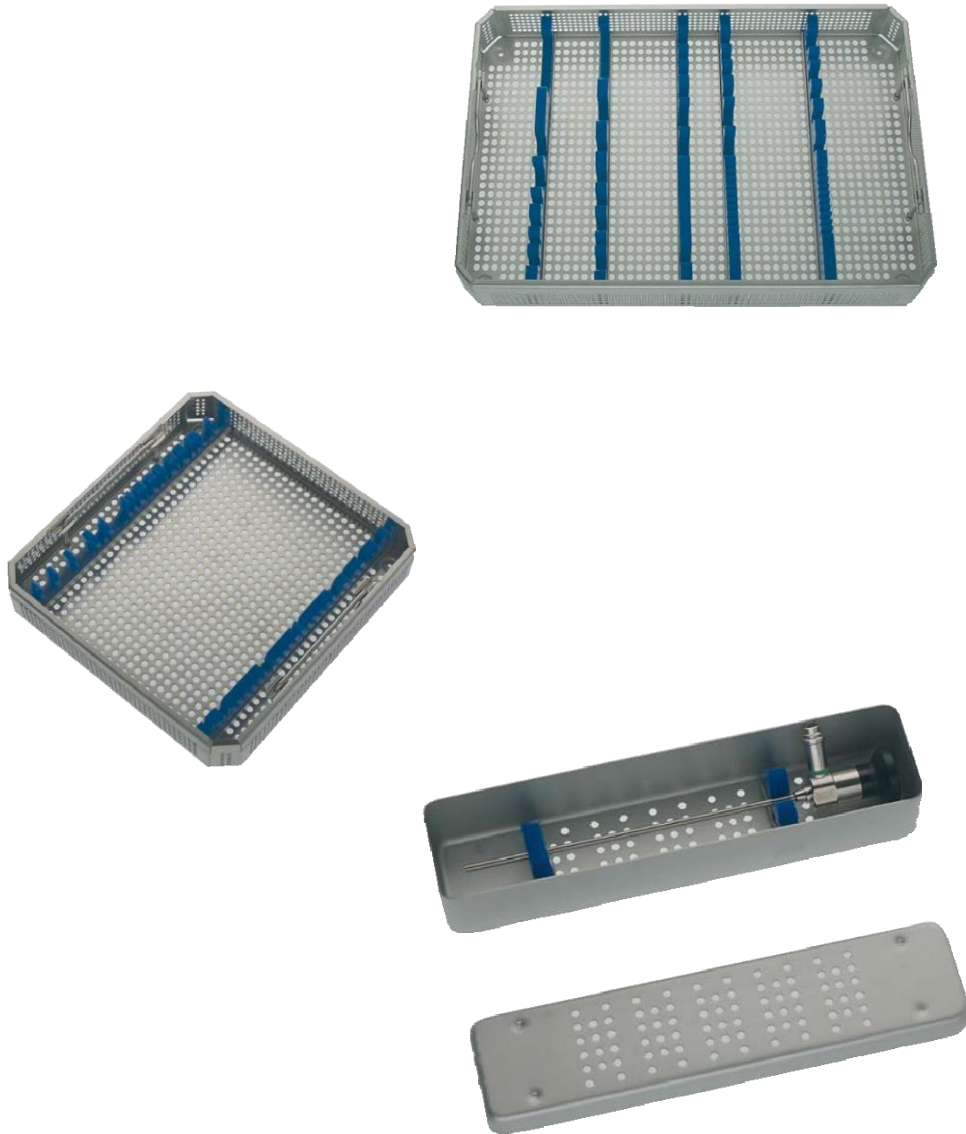

**Silikonlagerungen**

Silikonlagerungen schützen Ihre Instrumente während der Sterilisation, dem Transport und der Lagerung. Die Einteilung Ihres Sets ist flexibel - wir gestalten das Instrumentarium im Siebkorb nach Ihren Wünschen.

**Silicone fixation**















The silicone fixation protects your instruments during transportation, sterilisation and storage. The partitioning of the instruments is flexible and can be adapted to suit your specific requirements.

**Силиконовые фиксаторы**

Силиконовые накладки защищают ваши инструменты во время стерилизации, транспортировки и хранения. Расположение инструментальных наборов может быть сделано индивидуально по Вашему заказу.

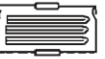

Suitability of our sterile containers for steam sterilization procedures<sup>1)</sup> as per DIN 58953, part 9 (issue May 1987)

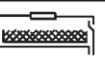
Sterilization container	Packing		Steam sterilization procedure acc.to DIN 58946, part I				
	Description	Symbolic representation and packing system	Gravitation procedure	Pre - vacuum procedure	Fractional vacuum procedure	Fractional flow procedure	Steam injection procedure
with filters (StB - F)	Textiles in sterilization container with filter in lid and bottom acc.to DIN 58952 part I		+	+	+	+	+
			0	0	+	+	+
	Textiles in sterilization container with filter in lid, bottom not perforated acc.to DIN 58952 part I		-	-	+	+	+
			-	-	+	+	0
	Textiles in sterilization container with filter in bottom lid, not perforated acc.to DIN 58952 part I		0	+	+	+	+
			-	0	+	+	+
	Instruments in wire basket acc.to DIN 58952 part III in sterilization container with filter in lid and bottom acc. to DIN 58952 part I		+ <sup>3)</sup>	+	+	+	+
	Instruments in wire basket acc.to DIN 58952 part III, in sterilization container with filter in lid and bottom not perforated acc. to DIN 58952 part I		-	+ <sup>2)</sup>	+ <sup>2)</sup>	+ <sup>2)</sup>	+ <sup>2)</sup>
	Instruments in wire basket acc.to DIN 58952 part III, in sterilization container with filter in bottom acc. to DIN 58952 part I		0	+	+	+	+
	with valves (StB - V)	Textiles in sterilization container with valves in lid and bottom acc. to DIN 58952 part I		-	0	+	+
			-	-	+	+	0
Textiles in sterilization container with valves in lid no valves on the bottom			-	-	+	+	-
			-	-	+	+	-
Instruments in wire basket in sterilization container with valve in lid and bottom			-	+ <sup>2)</sup>	+ <sup>2)</sup>	+ <sup>2)</sup>	+ <sup>2)</sup>
Instruments in wire basket in sterilization container with valve in lid and not perforated			-	+ <sup>2)</sup>	+ <sup>2)</sup>	+ <sup>2)</sup>	+ <sup>2)</sup>

Explanation of symbols : + applicable - not applicable 0 limited application

1) In order to avoid mistakes with regards to service, operation and/or when loading the sterilizer, please refer to table 1 for correct or wrong combination of sterilization containers for standardized steam sterilization procedures.  
 2) Only sterilization containers guaranteeing evaporation or discharge of condensate are suitable above.  
 3) Gravitation procedures having no drying device do not guarantee a sufficient after - drying effect.





Leicht  
Medizintechnik

**Tonometer  
Tonometer  
Le Tonometre  
El Tonometro  
Тонометр**

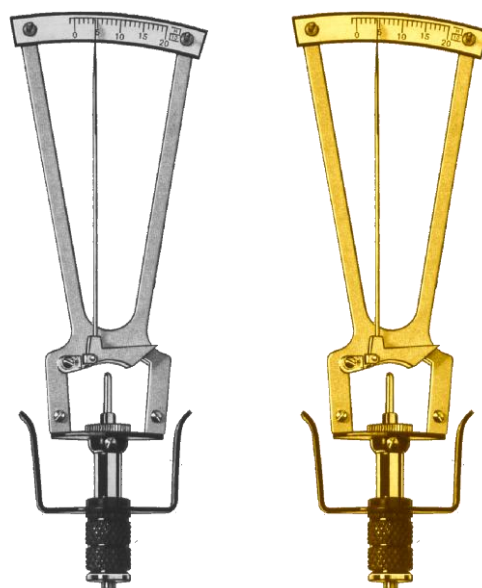





**Schioetz – TONOMETER**  
31-10-001-00

- komplett mit 3 Gewichten (5,5 g, 7,5 g und 10 g) in gerader oder 45° gebogener Skalenanordnung
- complete with set of 3 weight units (5.5, 7.5 and 10 grams). Available with either straight scale layout or scale curved to an angle of 45
- complet avec 3 poids (5,5 g, 7,5 g et 10 g), avec un cadre droit ou orient à 45 V.
- completo con 3 pesas (de 5,5gr, 7,5 gr y 10 gramos), con cuadro de escala recto o bien inclinado a 45
- в комплекте с 3-я весами (5,5 г., 7,5 г. и 10 г) с прямой и под 45° наклоненной шкалой

1. Eloxiertes Skalenr ager / anodized scale mount / Porte-cadran anodis / Portaescala anodizado / элoксирующий держатель шкалы
2. Zeiger und Hebel / pointer and lever / Aiguille et levier / Aguja y palanca / стрелка и ручка
3. Fingerb ugel und Quertr ager / finger rest and transversal support / Bride et support transversal / Ароуа-dedo y soporte transversal / пальчиковое коромысло и поперечный держатель
4. 10 g, 7,5 g und 5,5 g - Gewichte / 10 gram, 7.5 gram and 5.5 gram weight units / 4) Poids de 10, 7,5 g et 5,5 g / Pesas de 10 gramos, 7,5 gramos / 10 г, 7,5 г. 5,5 г веса

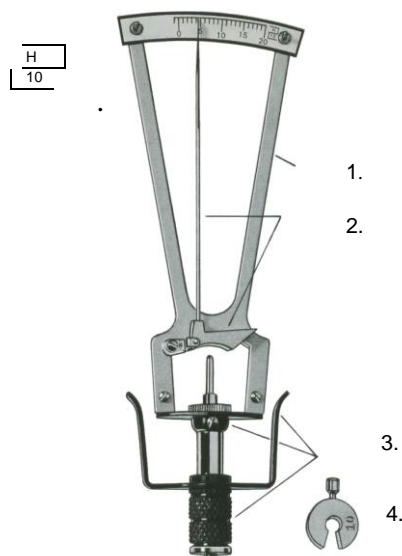

technische  nderungen vorbehalten  
Subject to any technical improve efficiency  
технические изменения допускаются



Leicht  
Medizintechnik

**Stimmgabeln für Ohrenärzte  
Tuning Forks for Aurists  
Diapasons pour auristes  
Diapasones para otologos  
Камертон для ЛОР врачей**





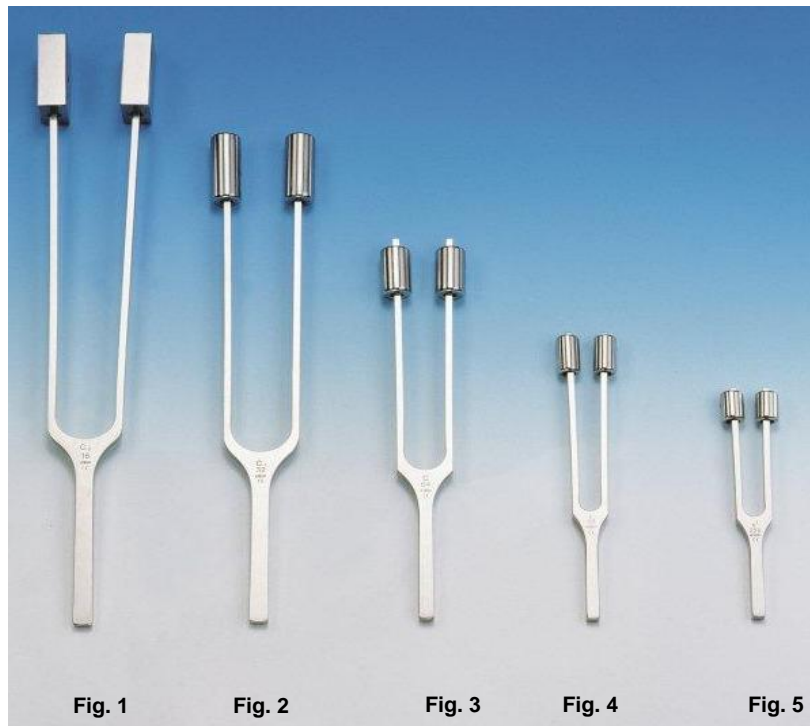

<b>Fig. 1</b>	<b>33-10-001-016</b>	= C <sub>-2</sub> 16 Hz (French)
<b>Fig. 2</b>	<b>33-10-002-032</b>	= C <sub>-1</sub> 32 Hz (French)
<b>Fig. 3</b>	<b>33-10-003-064</b>	= C 64 Hz (Hartmann)
<b>Fig. 4</b>	<b>33-10-004-128</b>	= c 128 Hz (Hartmann)
<b>Fig. 5</b>	<b>33-10-005-256</b>	= c <sup>1</sup> 256 Hz (Hartmann)

Stimmgabeln für Ohrenärzte ohne Dämpfer  
 Tuning Forks for Aurists without clamps  
 Diapasons pour auristes sans curseurs  
 Diapasones para otologos sin sordinas  
 Камертон для ЛОР врачей без глушителя



<b>Fig. 6</b>	<b>33-10-006- 128</b>	=c	128 Hz (Hartmann)
<b>Fig. 7</b>	<b>33-10-007- 256</b>	=c <sup>1</sup>	256 Hz (Hartmann)
<b>Fig. 8</b>	<b>33-10-008- 512</b>	=c <sup>2</sup>	512 Hz (Hartmann)
<b>Fig. 9</b>	<b>33-10-009-1024</b>	=c <sup>3</sup>	1024 Hz (Hartmann)
<b>Fig. 10</b>	<b>33-10-010-2048</b>	=c <sup>4</sup>	2048 Hz (Hartmann)
<b>Fig. 11</b>	<b>33-10-011-4096</b>	=c <sup>5</sup>	4096 Hz (Hartmann)



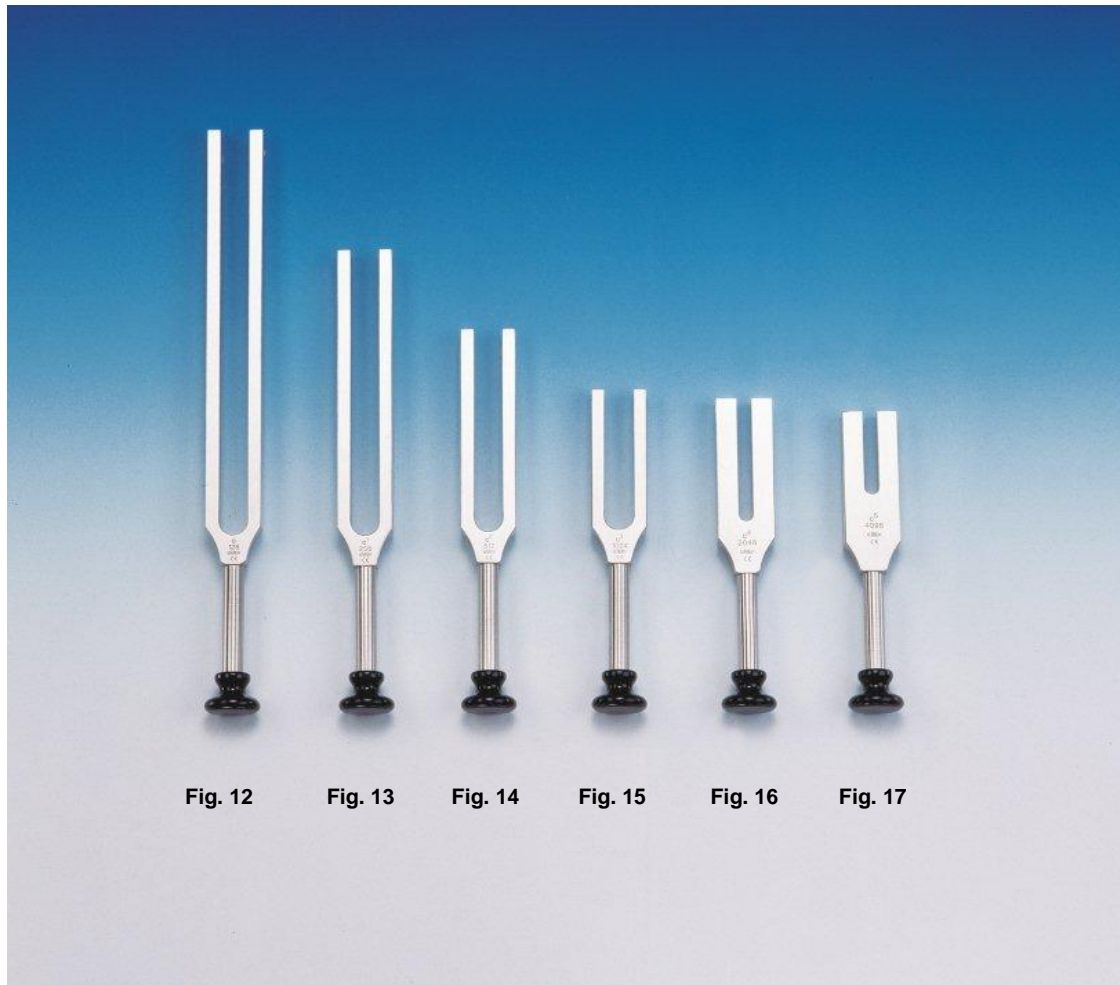

Fig. 12

Fig. 13

Fig. 14

Fig. 15

Fig. 16

Fig. 17

- |                |                       |                  |                 |
|----------------|-----------------------|------------------|-----------------|
| <b>Fig. 12</b> | <b>33-10-012- 128</b> | =c               | 128 Hz (Lucae)  |
| <b>Fig. 13</b> | <b>33-10-013- 256</b> | = c <sup>1</sup> | 256 Hz (Lucae)  |
| <b>Fig. 14</b> | <b>33-10-014- 512</b> | =c <sup>2</sup>  | 512 Hz (Lucae)  |
| <b>Fig. 15</b> | <b>33-10-015-1024</b> | =c <sup>3</sup>  | 1024 Hz (Lucae) |
| <b>Fig. 16</b> | <b>33-10-016-2048</b> | =c <sup>4</sup>  | 2048 Hz (Lucae) |
| <b>Fig. 17</b> | <b>33-10-017-4096</b> | =c <sup>5</sup>  | 4096 Hz (Lucae) |



Stimmgabeln für Ohren- und Nervenärzte  
 Tuning Forks for Aurists and Neurological Purposes  
 Diapasons pour auristes et pour neurologistes  
 Diapasones para otologos y para neurologia  
 Камертон для ЛОР врачей и невропатологов



- Fig. 18 33-10-018- 440 = a 440 Hz mit Fuß  
 Fig. 19 33-10-019- 64 = C 64 Hz / c 128 Hz, Dämpfer abnehmbar, mit Fuß, (Rydel-Seiffer)  
 Fig. 20 33-10-020- 109 = A 109 Hz verstellbar bis g 194 Hz, ohne Fuß (keine Abbildung)  
 Fig. 21 33-10-021- 109 = A 109 Hz verstellbar bis g 194 Hz, mit Fuß, (König)  
 Fig. 22 33-10-022- 128 = c 128 Hz verstellbar bis h 240 Hz, mit Fuß, (Lucae)  
 Fig. 23 33-10-023- 128 = c 128 Hz verstellbar bis h 240 Hz, ohne Fuß

- Fig. 18 33-10-018- 440 = a<sup>1</sup> 440 Hz wit foot  
 Fig. 19 33-10-019- 64 = C 64 Hz / c 128 Hz detachable clamps, with foot (Rydel-Seiffer)  
 Fig. 20 33-10-020- 109 = A 109 Hz adjustable up to g 194 Hz. without foot (not illustrated)  
 Fig. 21 33-10-021- 109 = A 109 Hz adjustable up to g 194 Hz. with foot (König)  
 Fig. 22 33-10-022- 128 = c 128 Hz adjustable up to h 240 Hz with foot (Lucae)  
 Fig. 23 33-10-023- 128 = c 128 Hz adjustable up to h 240 Hz without foot

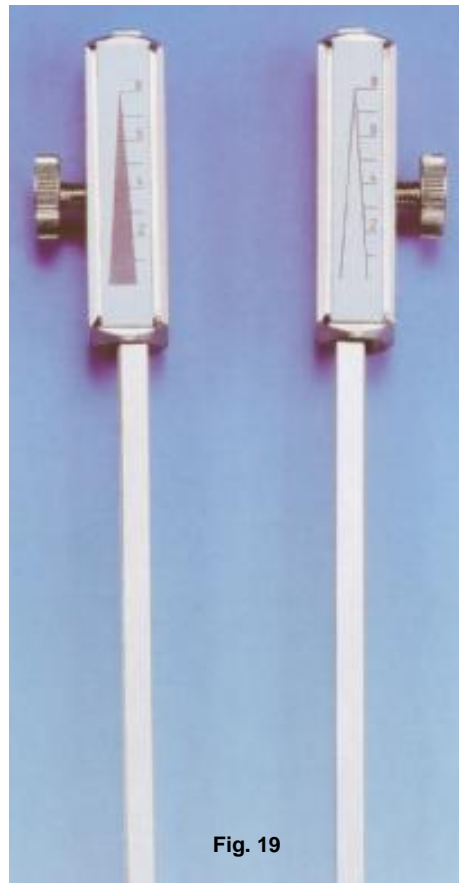

Fig. 19



Fig. 20/21



Fig. 22/23

Fig. 18	33-10-018- 440	= a <sup>1</sup>	440 Hz avec pied
Fig. 19	33-10-019- 64	= C	64 Hz / c 128 Hz, curseurs detachables, avec pied, (Rydel-Seiffer)
Fig. 20	33-10-020- 109	= A	109 Hz réglable jusqu'à g 194 Hz, sans pied ( <b>pas illustre</b> )
Fig. 21	33-10-021- 109	= A	109 Hz réglable jusqu'à g 194 Hz, avec pied (König)
Fig. 22	33-10-022- 128	= c	128 Hz réglable jusqu'à h 240 Hz, avec pied, (Lucae)
Fig. 23	33-10-023- 128	= c	128 Hz réglable jusqu'à h 240 Hz, sans pied

Fig. 18	33-10-018- 440	= a <sup>1</sup>	440 Hz con pie
Fig. 19	33-10-019- 64	= C	64 Hz / c 128 Hz, sordinas demontables, con pie, (Rydel-Seiffer)
Fig. 20	33-10-020- 109	= A	109 Hz graduable hasta g 194 Hz, sin pie ( <b>no ilustrado</b> )
Fig. 21	33-10-021- 109	= A	109 Hz graduable hasta g 194 Hz, con pie (König)
Fig. 22	33-10-022- 128	= c	128 Hz graduable hasta g 240 Hz, con pie, (Lucae)
Fig. 23	33-10-023- 128	= c	128 Hz graduable hasta g 240 Hz, sin pie,

Fig. 18	33-10-018- 440	= a <sup>1</sup>	440 Hz на ножке
Fig. 19	33-10-019- 64	= C	64 Hz / c 128 Hz со снимаемым глушителем на ножке (Rydel-Seiffer)
Fig. 20	33-10-020- 109	= A	109 Hz выставяемого до g 194 Hz, без ножки ( без картинки)
Fig. 21	33-10-021- 109	= A	109 Hz выставяемого до g 194 Hz, с ножкой (König)
Fig. 22	33-10-022- 128	= c	128 Hz выставяемого до h 240 Hz, с ножкой, (Lucae)
Fig. 23	33-10-023- 128	= c	128 Hz выставяемого до h 240 Hz, без ножки

Stimmgabelbesteck für Ohrenärzte  
Sets of Tuning Forks for Aurists  
Jeux de diapasons pour auristes  
Juegos de Diapasones para otologos  
Камертон, набор для ЛОР врачей



Fig. 24



Fig. 25

Stimmgabelbesteck für Ohrenärzte (im Samtetui / Kunstleder bezogen)  
Sets of Tuning Forks for Aurists (in velvet-lined case / imitation leathera referred)  
Jeux de diapasons pour auristes (en boîte gamie de velours / les similis-cuir ont renvoye)  
Juegos de Diapasones para otologos (en estuche forrado de terciopelo / pieles artificials referidas)  
Камертон, набор для ЛОР врачей (на бархате / в футляре, обтянутом кожей)

**Fig. 24 33-10-024-00**

**Erweitertes Besteck nach Hartmann** (c 128Hz/ c<sup>1</sup> 256 Hz/ c<sup>3</sup> 1024 Hz/ c<sup>4</sup> 2048 Hz/ c<sup>5</sup> 4096 Hz)  
**Augmented set of tuning forks, pattern Hartmann** (c 128Hz/ c<sup>1</sup> 256 Hz/ c<sup>3</sup> 1024 Hz/ c<sup>4</sup> 2048 Hz/ c<sup>5</sup> 4096 Hz)  
**Eu augmente de diapasons selon Hartmann** (c 128Hz/ c<sup>1</sup> 256 Hz/ c<sup>3</sup> 1024 Hz/ c<sup>4</sup> 2048 Hz/ c<sup>5</sup> 4096 Hz)  
**Juego mas completo de diapasones, segun Hartmann** (c 128Hz/ c<sup>1</sup> 256 Hz/ c<sup>3</sup> 1024 Hz/ c<sup>4</sup> 2048 Hz/ c<sup>5</sup> 4096 Hz)  
**Расширенный набор по Hartmann** (c 128Hz/ c<sup>1</sup> 256 Hz/ c<sup>3</sup> 1024 Hz/ c<sup>4</sup> 2048 Hz/ c<sup>5</sup> 4096 Hz)

**Fig. 25 33-10-025-00**

**Stimmgabelbesteck nach Hartmann** (c 128Hz/ c<sup>1</sup> 256 Hz/ c<sup>3</sup> 1024 Hz/ c<sup>4</sup> 2048 Hz)  
**Set of tuning forks pattern Hartmann** (c 128Hz/ c<sup>1</sup> 256 Hz/ c<sup>3</sup> 1024 Hz/ c<sup>4</sup> 2048 Hz)  
**Jeu de diapasons selon Hartmann** (c 128Hz/ c<sup>1</sup> 256 Hz/ c<sup>3</sup> 1024 Hz/ c<sup>4</sup> 2048 Hz)  
**Juego de diapasones segun Hartmann** (c 128Hz/ c<sup>1</sup> 256 Hz/ c<sup>3</sup> 1024 Hz/ c<sup>4</sup> 2048 Hz)  
**Набор камертоновых вилок по Hartmann** (c 128Hz/ c<sup>1</sup> 256 Hz/ c<sup>3</sup> 1024 Hz/ c<sup>4</sup> 2048 Hz)



Fig. 26

Stimmgabelbesteck für Ohrenärzte (im Samteti / Leder bezogen)  
Sets of Tuning Forks for Aurists (in velvet-lined case / imitation leather referred)  
Jeux de diapasons pour auristes (en boîte garnie de velours / les similis-cuir ont renvoye)  
Juegos de Diapasones para otologos (en estuche forrado de terciopelo / pieles artificiales referidas)  
Камертон, набор для ЛОР врачей (на бархате/ в футляре, обтянутом кожей)

Fig. 26 33-10-026-00

**Großes Besteck nach Hartmann-Ostmann** (C<sub>-1</sub> 32 Hz/ C 64 Hz/c 128Hz/ c<sup>1</sup> 256 Hz/ c<sup>3</sup> 1024 Hz/ c<sup>4</sup> 2048 Hz/ c<sup>5</sup> 4096 Hz)  
**Large set, pattern Hartmann-Ostmann** (C<sub>-1</sub> 32 Hz/ C 64 Hz/c 128Hz/ c<sup>1</sup> 256 Hz/ c<sup>3</sup> 1024 Hz/ c<sup>4</sup> 2048 Hz/ c<sup>5</sup> 4096 Hz)  
**Jeu grand selon Hartman-Ostmann** (C<sub>-1</sub> 32 Hz/ C 64 Hz/c 128Hz/ c<sup>1</sup> 256 Hz/ c<sup>3</sup> 1024 Hz/ c<sup>4</sup> 2048 Hz/ c<sup>5</sup> 4096 Hz)  
**Juego grande, segun Hartmann-Osmann** (C<sub>-1</sub> 32 Hz/ C 64 Hz/c 128Hz/ c<sup>1</sup> 256 Hz/ c<sup>3</sup> 1024 Hz/ c<sup>4</sup> 2048 Hz/ c<sup>5</sup> 4096 Hz)  
**Большой набор по Hartmann-Osmann** (C<sub>-1</sub> 32 Hz/ C 64 Hz/c 128Hz/ c<sup>1</sup> 256 Hz/ c<sup>3</sup> 1024 Hz/ c<sup>4</sup> 2048 Hz/ c<sup>5</sup> 4096 Hz)



Stimmgabeln aus Aluminium-Legierung  
 Touning forks made from aluminium-alloy  
 Diapasons d'un alliage aluminium  
 Diapason de aleacion al aluminio  
 Камертон из алюминиевого сплава

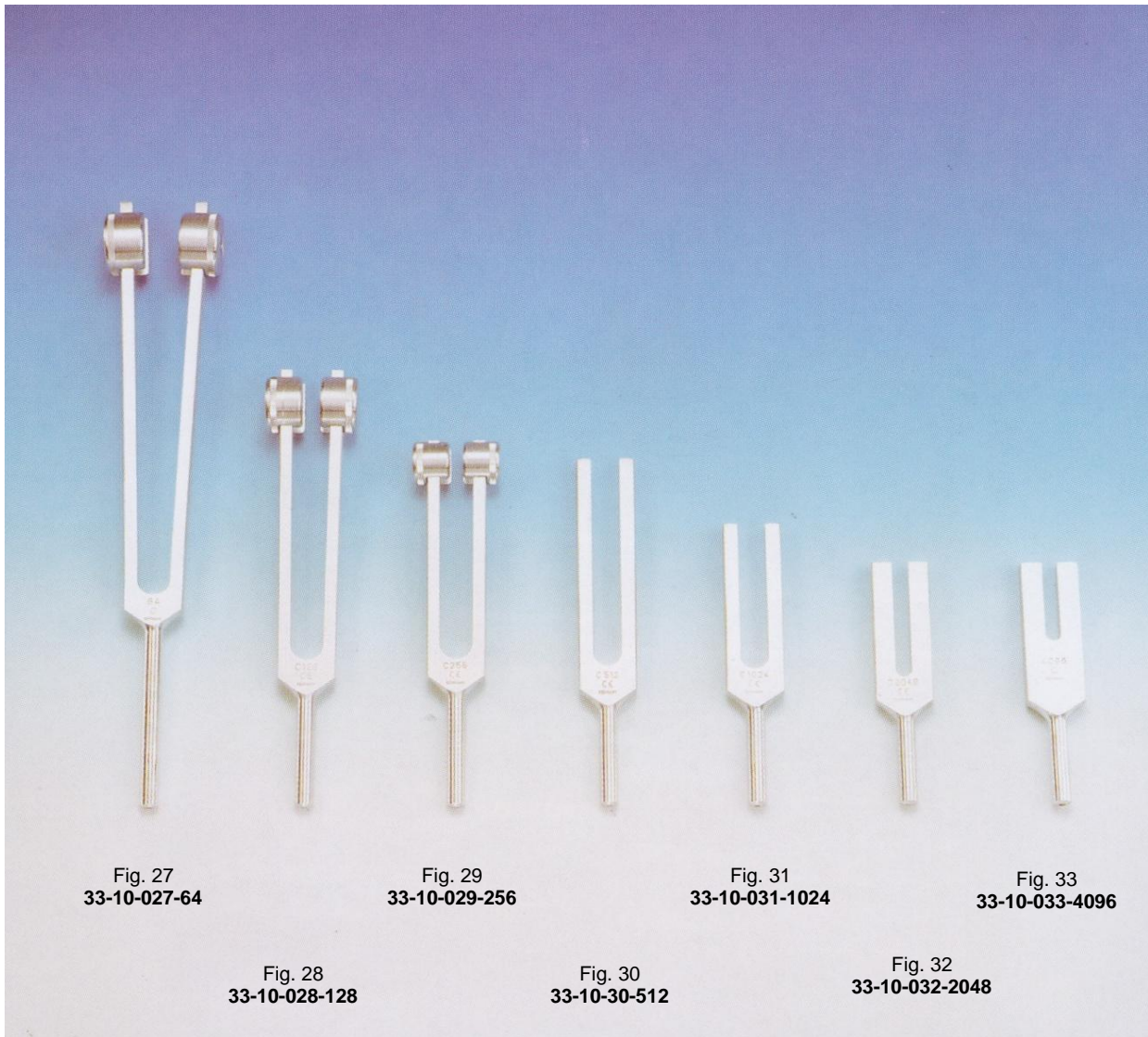

**Stimmgabeln aus Aluminium-Legierung** für medizinische Zwecke, z.B. für Gehörprüfungen (Luft- und Knochenleitungen, für Sensibilitätsprüfungen und andere diagnostischen Zwecke (C 64 Hz/c 128Hz/ c<sup>1</sup> 256 Hz/ c<sup>3</sup> 1024 Hz/ c<sup>4</sup> 2048 Hz/ c<sup>5</sup> 4096 Hz)

**Touning forks made from aluminium-alloy**, for medical purposes, such as examination of hearing (air and bone conduction), for sensibility examinations, and other diagnostic purposes (C 64 Hz/c 128Hz/ c<sup>1</sup> 256 Hz/ c<sup>3</sup> 1024 Hz/ c<sup>4</sup> 2048 Hz/ c<sup>5</sup> 4096 Hz)

**Diapasons d'un alliage aluminium**, concus specifiquement pour fins de Diagnostiques medicaux (C 64 Hz/c 128Hz/ c<sup>1</sup> 256 Hz/ c<sup>3</sup> 1024 Hz/ c<sup>4</sup> 2048 Hz/ c<sup>5</sup> 4096 Hz)

**Diapason de aleacion al aluminio**, destinado a fines medicos por ejemplo, determinacion de agudeza auditiv-sensibilidad (de transmision en cuanto al aire y las piezas oseas, en diagnosticos sobre sensibilitad y de otras lndoles (C 64 Hz/c 128Hz/ c<sup>1</sup> 256 Hz/ c<sup>3</sup> 1024 Hz/ c<sup>4</sup> 2048 Hz/ c<sup>5</sup> 4096 Hz)

**Камертон из алюминиевого сплава**, предназначен для медицинских целей, например, для проверки слуха (проводимость по воздуху, чувствительность и для других диагностических целей) (C 64 Hz/c 128Hz/ c<sup>1</sup> 256 Hz/ c<sup>3</sup> 1024 Hz/ c<sup>4</sup> 2048 Hz/ c<sup>5</sup> 4096 Hz)



Satz von 5 Aluminium-Legierung Stimmgabeln, im Etui  
Set of 5 aluminium-alloy tuning forks, in a case  
Jeu de 5 diapasons, alliage aluminium, dans un etui  
Juego especial integrado por 5 diapasones en acero al aluminio, en estuche  
Набор из 5 алюминиевых камертоновых вилок, в футляре



Fig. 34  
33-10-034-00

**Fig. 34** Satz von 5 Aluminium-Legierung Stimmgabeln, in Etui  
Set of 5 aluminium-alloy tuning forks, in a case  
Jeu de 5 diapasons, alliage aluminium, dans un etui  
Juego especial integrado por 5 diapasones en acero al aluminio, en estuche  
Набор из 5 камертонов из алюминиевого сплава (в футляре)

**Fig. 28 - Fig. 32** (c 128Hz/ c<sup>1</sup> 256 Hz/ c<sup>3</sup> 1024 Hz/ c<sup>4</sup> 2048 Hz/ c<sup>5</sup> 4096 Hz)



Neurologische Kombinations-Stimmgabel „NEUROTONE – 5“ (mit Etui)  
 Neurological Multi-Function Tuning Fork „NEUROTONE – 5“ (in a case)  
 Neurologique diapason combinaison „NEOROTONE – 5“ (dans un etui)  
 Diapason combinado para neurologia „NEOROTONE – 5“ (en estuche)  
 Неврологический комбинированный камертон «NEUROTONE – 5» (в футляре)

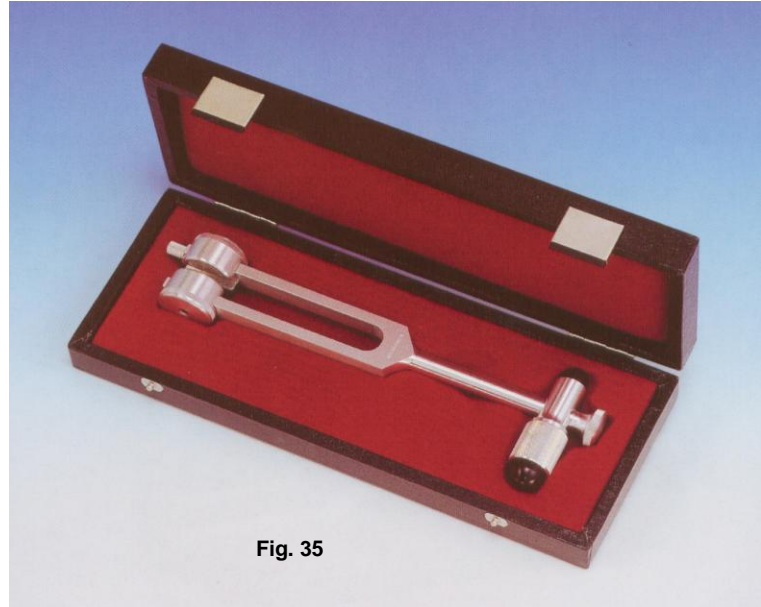

Fig. 35

Fig. 35 33-10-035-00

**In dieser Stimmgabel wurden 5 verschiedene Instrumente für umfassende neurologische Diagnosen vereint:**

Stimmgabel für Gehör- und Vibrationstest (Luft- und Knochenleitung)  
 Der Perkussions-Hammer zum Test der Sehnenreflexe  
 Das Nadelrad (Wartenberg-Rad) zur Prüfung der Schmerzempfindlichkeit  
 Die Nadel zum Test verschiedener Hautreflexe  
 Der Pinsel für Prüfungen der Haut- und Oberflächensensibilität

**This universal neurological tuning fork combines 5 different separate diagnostic instruments:**

The tuning fork for audio testing and vibration sensation (air and bone conduction)  
 The percussion hammer for testing sinew reflexes  
 The pin wheel (Wartenberg) for testing pain sensibility  
 The needle for testing different reflexes of the skin  
 The brush for different tests of the skin and surface sensibility

**En este diapason fueron reunidos 5 instrumentos diferents para extensos diagnosticos neurologicos:**

El diapason para el conducto auditivo y prueba de de vibration (aire y conducto de huesos)  
 El martillo de percusion para prueba de reflejo de los tendons  
 La rueda de agujas (Wartenberg-Rad) para exsaminar la sensibilidad de dolores  
 La aguja para examinar los diferentes reflejos de la piel  
 El pincel para examinar la sensibilidad de la superficie cutanea

**Этот комбинированный камертон соединяет в себе 5 различных инструментов диагностирования:**

Камертон для проверки слуха и вибрационного теста  
 Перкусионный молоточек для проверки рефлексов сухожилий  
 Игла (Wartenberg-Rad) для проверки чувствительности на боль  
 Игла для проверки чувствительности кожи  
 Кисточка для проверки поверхности кожи на сенсibilitет

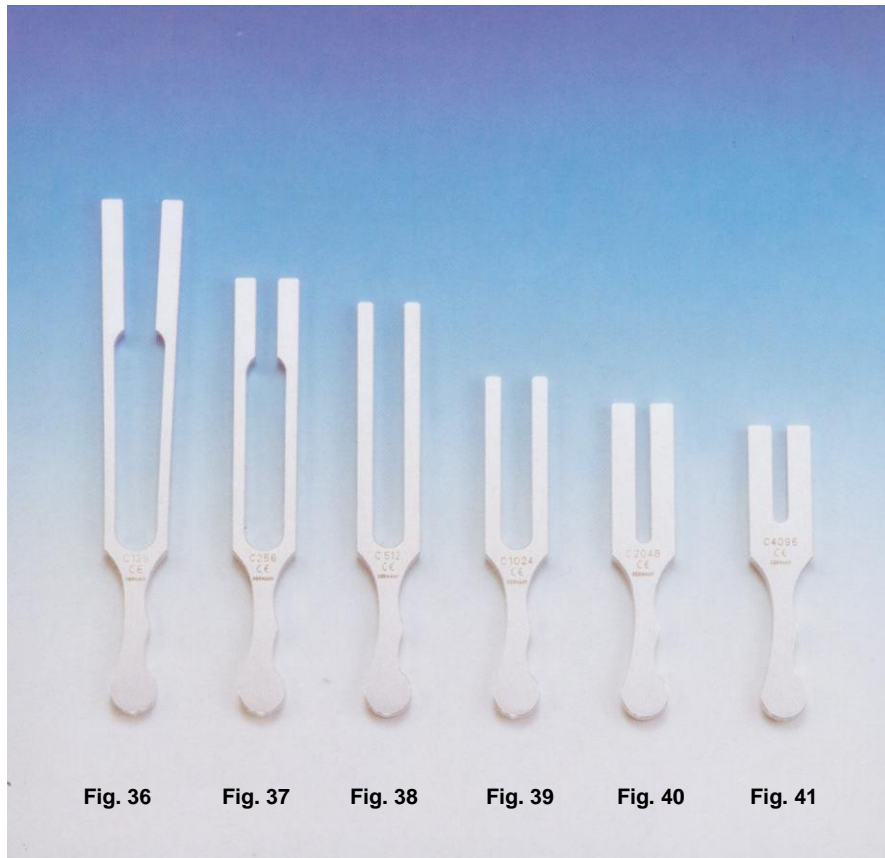

Fig. 36 33-10-036-00  
Fig. 37 33-10-037-00  
Fig. 38 33-10-038-00  
Fig. 39 33-10-039-00  
Fig. 40 33-10-040-00  
Fig. 41 33-10-041-00

**NG-Stimmgabeln aus Aluminium-Legierung** für medizinische Zwecke, z.B. für Gehörprüfungen  
ähnlich Fig. 36 bis 41, Griff ergonomisch, Gewichte integriert (c 128Hz/ c<sup>1</sup> 256 Hz/ c<sup>3</sup> 1024 Hz/ c<sup>4</sup> 2048 Hz/ c<sup>5</sup> 4096 Hz)

**NG-Tuning forks made from alluminum-alloy**, for medical purposes, simiarly Fig 36 - Fig.41,  
ergonomic gras, integrated weights (c 128Hz/ c<sup>1</sup> 256 Hz/ c<sup>3</sup> 1024 Hz/ c<sup>4</sup> 2048 Hz/ c<sup>5</sup> 4096 Hz)

**Ng-Diapasons d'un alliage aluminium**, concus specifiquement pour fins de Diagnostiques medicaux, de facon semblable  
Fig. 36 - Fig. 41, prise ergonomique, poids integers (c 128Hz/ c<sup>1</sup> 256 Hz/ c<sup>3</sup> 1024 Hz/ c<sup>4</sup> 2048 Hz/ c<sup>5</sup> 4096 Hz)

**NG-Diapason de aleacion al aluminio**, destinado a fines medicos por ejemplo, determinacion de agudeza auditiv-  
sensibilidad semejantemente Fig. 36 - Fig 41, asimiento ergonomico, pesos integrados (c 128Hz/ c<sup>1</sup> 256 Hz/ c<sup>3</sup> 1024 Hz/ c<sup>4</sup> 2048 Hz/ c<sup>5</sup> 4096 Hz)

**NG-камертон алюминиевый медицинского назначения**, например, для проверки слуха, подобный Fig. 36 - Fig.  
41, ручка эргономической формы, с интегрированными грузиками (c 128Hz/ c<sup>1</sup> 256 Hz/ c<sup>3</sup> 1024 Hz/ c<sup>4</sup> 2048 Hz/ c<sup>5</sup> 4096 Hz)



Anschlaghammer  
Touching hammer  
Marteau a toucher  
Martillo de tocar para  
Ударный молоточек

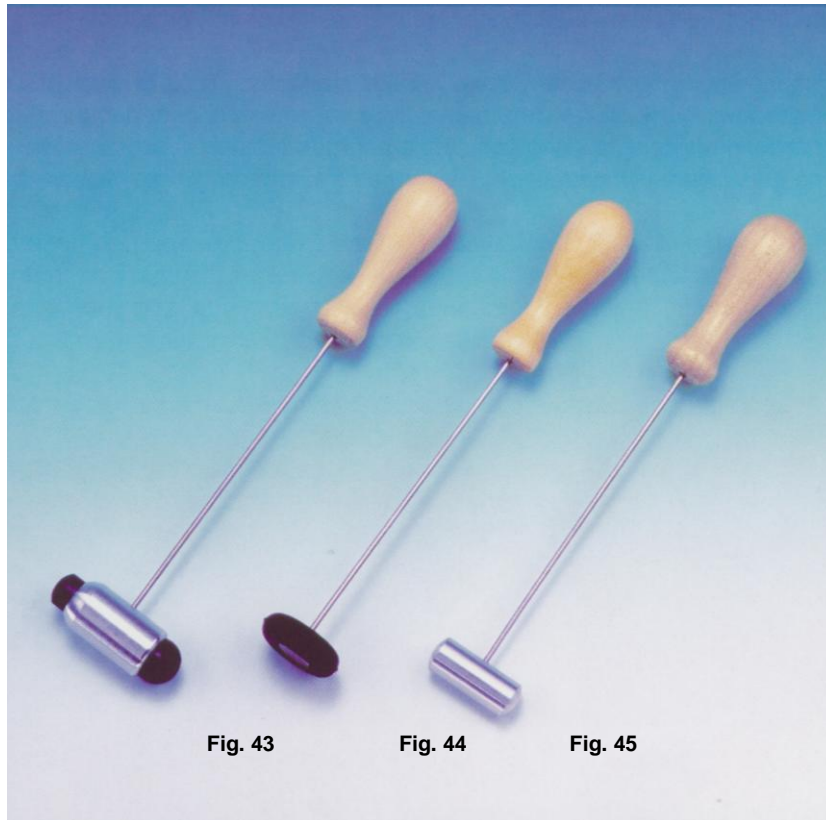

Fig. 43

Fig. 44

Fig. 45

Fig. 43 33-10-044-00

Anschlaghammer für Stimmgabeln der Tone  $c^3$  1024 Hz /  $c^4$  2048 Hz /  $c^5$  4096 Hz  
Touching hammer for Tuning Forks of tones  $c^3$  1024 Hz /  $c^4$  2048 Hz /  $c^5$  4096 Hz  
Marteau a toucher les diapasons des sons  $c^3$  1024 Hz /  $c^4$  2048 Hz /  $c^5$  4096 Hz  
Martillo de tocar para los diapasones de tonos  $c^3$  1024 Hz /  $c^4$  2048 Hz /  $c^5$  4096 Hz  
Ударный молоточек для камертона тонов  $c^3$  1024 Hz /  $c^4$  2048 Hz /  $c^5$  4096 Hz

Fig. 44 33-10-045-00

Anschlaghammer für Stimmgabeln der Tone  $c$  128 Hz /  $c^1$  256 Hz /  $c^3$  1024 Hz /  $c^4$  2048 Hz /  $c^5$  4096 Hz,  
mit zwei verschiedenen harten Einsätzen  
Touching hammer for Tuning Forks of tones  $c$  128 Hz /  $c^1$  256 Hz /  $c^3$  1024 Hz /  $c^4$  2048 Hz /  $c^5$  4096 Hz  
with two different touching-surfaces  
Marteau a toucher les diapasons des sons  $c$  128 Hz /  $c^1$  256 Hz /  $c^3$  1024 Hz /  $c^4$  2048 Hz /  $c^5$  4096 Hz  
avec deux autres mise dures  
Martillo de tocar para los diapasones de tonos  $c$  128 Hz /  $c^1$  256 Hz /  $c^3$  1024 Hz /  $c^4$  2048 Hz /  
 $c^5$  4096 Hz con dos diferente durus insertadaes  
Ударный молоточек для камертона тонов  $c$  128 Hz /  $c^1$  256 Hz /  $c^3$  1024 Hz /  $c^4$  2048 Hz /  $c^5$  4096 Hz  
с двумя различными по твердости насадками

Fig. 45 33-10-045-00

Anschlaghammer für Stimmgabeln der Tone  $c$  128 Hz bis  $c^3$  1024 Hz  
Touching hammer for Tuning Forks of tones  $c$  128 Hz to  $c^3$  1024 Hz  
Marteau a toucher les diapasons des sons  $c$  128 Hz jusqu'a  $c^3$  1024 Hz  
Martillo de tocar para los diapasones de tonos  $c$  128 Hz hasta  $c^3$  1024 Hz  
Ударный молоточек для камертона тонов  $c$  128 Hz до  $c^3$  1024 Hz



Leicht  
Medizintechnik

**HNO-Instrumente  
NHO-Instruments  
ЛОР-инструменты**





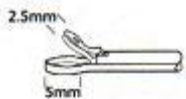

**37-23-072-60** Durchschneidende Blakesley Zange, Größe 2,5 x 5 mm, gerade  
Thru Bite Blakesley forceps, size 2,5 x 5 mm, Pediatric, straight  
Выкусыватель Blakesley, размер 2,5 x 5 мм, прямой



**37-23-072-80** Durchneidende Blakesley Zange, Größe 3,6 x 8 mm, gerade  
Thru Bite Blakesley forceps, size 3,6 x 8 mm, straight  
Выкусыватель Blakesley, размер 3,6 x 8 мм, прямой



**37-23-073-00** Durchneidende Blakesley Zange, Größe 4,8 x 14 mm, gerade  
Thru Bite Blakesley forceps, size 4,8 x 14 mm, straight  
Выкусыватель Blakesley, размер 4,8 x 14 мм, прямой



**37-23-072-70** Durchneidende Blakesley Zange, Größe 2,5 x 5,5 mm, 45° gewinkelt  
Thru Bite Blakesley forceps, size 2,5 x 5,5 mm, 45°, Pediatric, angled  
Выкусыватель Blakesley, размер 2,5 x 5,5 мм, изогнутый под углом 45°

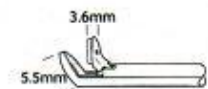

**37-23-072-90** Durchneidende Blakesley Zange, Größe 3,6 x 5,5 mm, 45° gewinkelt  
Thru Bite Blakesley forceps, size 3,6 x 5,5 mm, 45°, angled  
Выкусыватель Blakesley, размер 3,6 x 5,5 мм, изогнутый под углом 45°



**37-23-073-10** Durchneidende Blakesley Zange, Größe 4,8 x 13,0 mm, 45° gewinkelt  
Thru Bite Blakesley forceps, size 4,8 x 13,0 mm, 45°, angled  
Выкусыватель Blakesley, размер 4,8 x 13,0 мм, изогнутый под углом 45°



**37-23-074-30** Durchneidende Blakesley Zange, Größe 3,6 x 6,5 mm, links  
Thru Bite Blakesley forceps, size 3,6 x 6,5 mm, curved left  
Выкусыватель Blakesley, размер 3,6 x 6,5 мм, левосторонний



**37-23-074-20** Durchneidende Blakesley Zange, Größe 3,6 x 6,5 mm, rechts  
Thru Bite Blakesley forceps, size 3,6 x 6,5 mm, curved right  
Выкусыватель Blakesley, размер 3,6 x 6,5 мм, правосторонний

**Weil Blakesley Zange mit Absaugen**  
**Weil Blakesley Forceps with suction**  
**Выкусыватели Blakesley с отсасыванием**

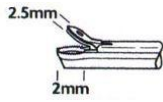

**37-70-230-736** Durchneidende Blakesley Zange mit Absaugen, Größe 2,5 x 2,0 mm, Länge 105 mm, gerade  
 Thru Bite Blakesley forceps wit Suction, size 2,5 x 2,0 mm, Shaft Length 105 mm, Straight  
 2,5 x 2,0 mm, длина 105 mm  
 Выкусыватель Blakesley с отсасыванием, размер 2,5 x 2,0 mm, длина 105 mm, прямой

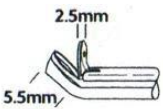

**37-70-230-737** Durchneidende Blakesley Zange mit Absaugen, Größe 2,5 x 5,5 mm, Länge 95 mm gewinkelt  
 Thru Bite Blakesley forceps wit Suction, size 2,5 x 5,5 mm, Length 95 mm, upturned  
 2,5 x 5,5 mm, длина 95 mm  
 Выкусыватель Blakesley с отсасыванием, размер 2,5 x 5,5 mm, длина 95 mm, изогнутый



**37-70-230-738** Durchneidende Blakesley Zange mit Absaugen, Größe 3,6 x 9,0 mm, Länge 105 mm, gerade  
 Thru Bite Blakesley forceps wit Suction, size 3,6 x 9,0 mm, Shaft Length 105 mm, Straight  
 3,6 x 9,0 mm, длина 105 mm  
 Выкусыватель Blakesley с отсасыванием, размер 3,6 x 9,0 mm, длина 105 mm, прямой

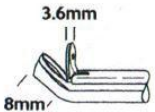

**37-70-230-739** Durchneidende Blakesley Zange mit Absaugen, Größe 3,6 x 8,0 mm, Länge 95 mm gewinkelt  
 Thru Bite Blakesley forceps wit Suction, size 3,6 x 8,0 mm, Length 95 mm, upturned  
 3,6 x 8,0 mm, длина 95 mm  
 Выкусыватель Blakesley с отсасыванием, размер 3,6 x 8,0 mm, длина 95 mm, изогнутый



**37-70-230-740** Durchneidende Blakesley Zange mit Absaugen, Größe 4,8 x 14,0 mm, Länge 105 mm, gerade  
 Thru Bite Blakesley forceps wit Suction, size 4,8 x 14,0 mm, Shaft Length 105 mm, Straight  
 4,8 x 14,0 mm, длина 105 mm  
 Выкусыватель Blakesley с отсасыванием, размер 4,8 x 14,0 mm, длина 105 mm, прямой



**37-70-230-741** Durchneidende Blakesley Zange mit Absaugen, Größe 4,8 x 10,0 mm, Länge 95 mm gewinkelt  
 Thru Bite Blakesley forceps wit Suction, size 4,8 x 10,0 mm, Length 95 mm, upturned  
 4,8 x 10,0 mm, длина 95 mm  
 Выкусыватель Blakesley с отсасыванием, размер 4,8 x 10,0 mm, длина 95 mm, изогнутый

FORCEPS STYLE BACKBITERS



Durchneidende Blakesley Zange  
Lightweight forceps design with backbiting jaws  
Выкусыватели Blakesley



37-23-071-60	Pädiatrische durchneidende Zange, gerade / Pediatric Backbiter, straight / Выкусыватель педиатрический, прямой	1x4mm
37-23-071-70	Pädiatrische durchneidende Zange, rechts / Pediatric Backbiter, right / Выкусыватель педиатрический, правый	1x4mm
37-23-071-80	Pädiatrische durchneidende Zange, links / Pediatric Backbiter, left / Выкусыватель педиатрический, левый	1x4mm
37-23-071-90	Medium durchneidende Zange, gerade / Medium Backbiter, straight / Средний выкусыватель, прямой	1,5x8mm
37-23-072-00	Medium durchneidende Zange, rechts / Medium Backbiter, right / Средний выкусыватель, правый	1,5x8mm
37-23-072-10	Medium durchneidende Zange, links / Medium Backbiter, left / Средний выкусыватель, левый	1,5x8mm
37-23-072-20	Große durchneidende Zange, gerade / Large Backbiter, straight / Большой выкусыватель, прямой	2x10mm
37-23-072-30	Große durchneidende Zange, rechts / Large Backbiter, right / Большой выкусыватель, правый	2x10mm
37-23-072-40	Große durchneidende Zange, links / Large Backbiter, left / Большой выкусыватель, левый	2x10mm

Aufsätze gerieft und scharfe Löffel  
Cutting and Grasping Forceps Tips  
Насадки для Huber



40-45-470-00

gerade - straight



Länge Length	gerade straight	kniegebogen angulares	gebogen curved
10 cm	40-45-470-10		
12 cm	40-45-470-12		
15 cm	40-45-470-15		
18 cm	40-45-470-18		
20 cm	40-45-470-20	40-45-477-20	40-45-475-20
25 cm	40-45-470-25	40-45-477-25	40-45-475-25
30 cm	40-45-470-30	40-45-477-30	40-45-475-30
35 cm	40-45-470-35	40-45-477-35	40-45-475-35
40 cm	40-45-470-40	40-45-477-40	40-45-475-40
45 cm	40-45-470-45	40-45-477-45	
50 cm	40-45-470-50	40-45-477-50	
60 cm	40-45-470-60	40-45-477-60	





Zangenaufsatz  
gerieft  
serrated  
40-45-480-00



Zangenaufsatz  
Hechtmaul  
40-45-482-00



Baracani  
40-45-481-00



Fraenkel  
lange Löffel  
40-45-483-00



Lange, ovale Löffel  
Fig. 1 40-45-488-00  
Fig. 2 40-45-488-01  
Fig. 3 40-45-488-03



Bruenings, runde Löffel  
Fig.1 40-45-486-02 2 mm  
Fig.2 40-45-486-03 3 mm  
Fig.3 40-45-486-04 4 mm  
Fig.4 40-45-486-05 5 mm  
Fig.5 40-45-486-06 6 mm



Bruenings, runde Löffel  
aufgebogen  
Fig. 1 40-45-487-02  
Fig. 2 40-45-487-03  
Fig. 3 40-45-487-03



Scheinman  
abgewinkelte Löffel  
40-45-484-00



**Aufsätze gerieft und scharfe Löffel**  
**Cutting and Grasping Forceps Tips**  
**Насадки для Huber**



**Krause**  
durchschneidend



40-45-489-00



40-45-489-01



40-45-489-02



**Krause**  
durchschneidend



40-45-490-00



40-45-490-01



40-45-490-02



**Scheinmann**  
durchschneidend  
abgewinkelt



40-45-496-00



**Rosenberg**  
aufeinander-  
schneidend

40-45-495-00



**Schuhmacher**  
mit ziehendem  
Schnitt



40-45-492-00



**Cordes**  
stanzend

40-45-491-01

40-45-491-02

40-45-491-03

40-45-491-04



**Cordes**  
stanzend



40-45-493-01



**Cordes**  
stanzend



40-45-493-02



Leicht  
Medizintechnik

## Nasal Spekula Nasal Spekula Носовые зеркала

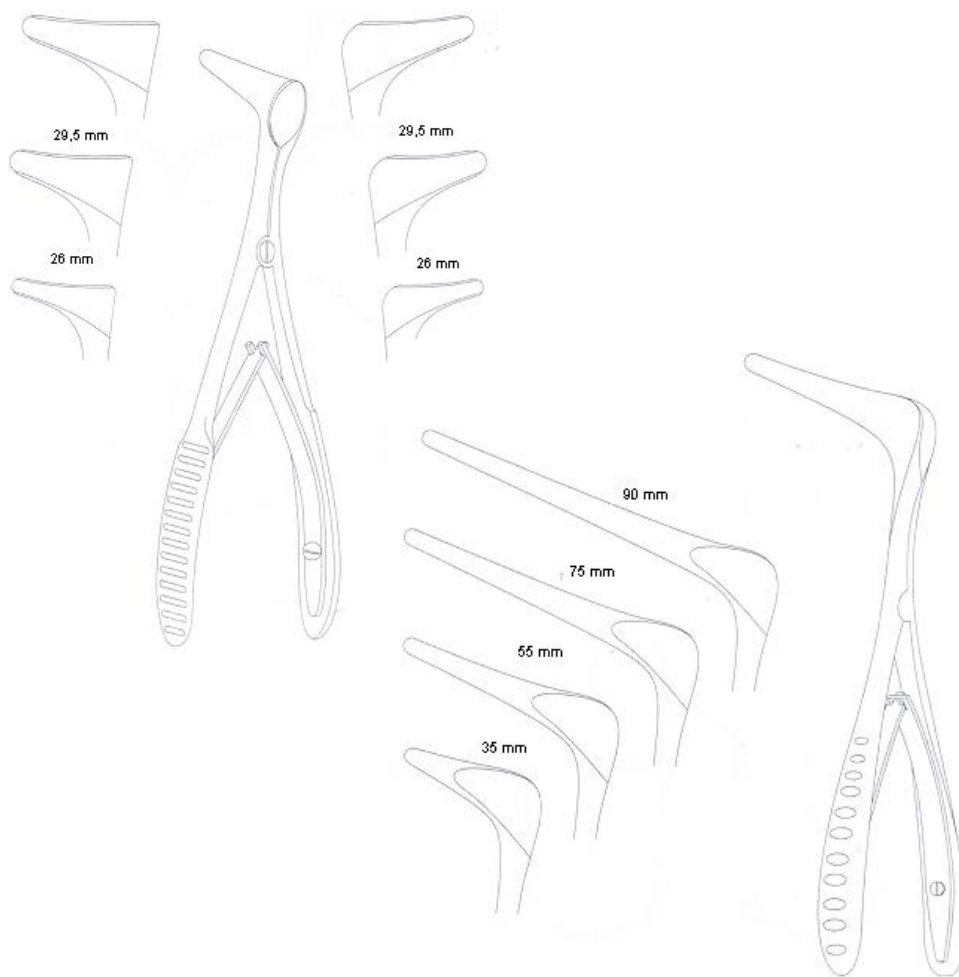



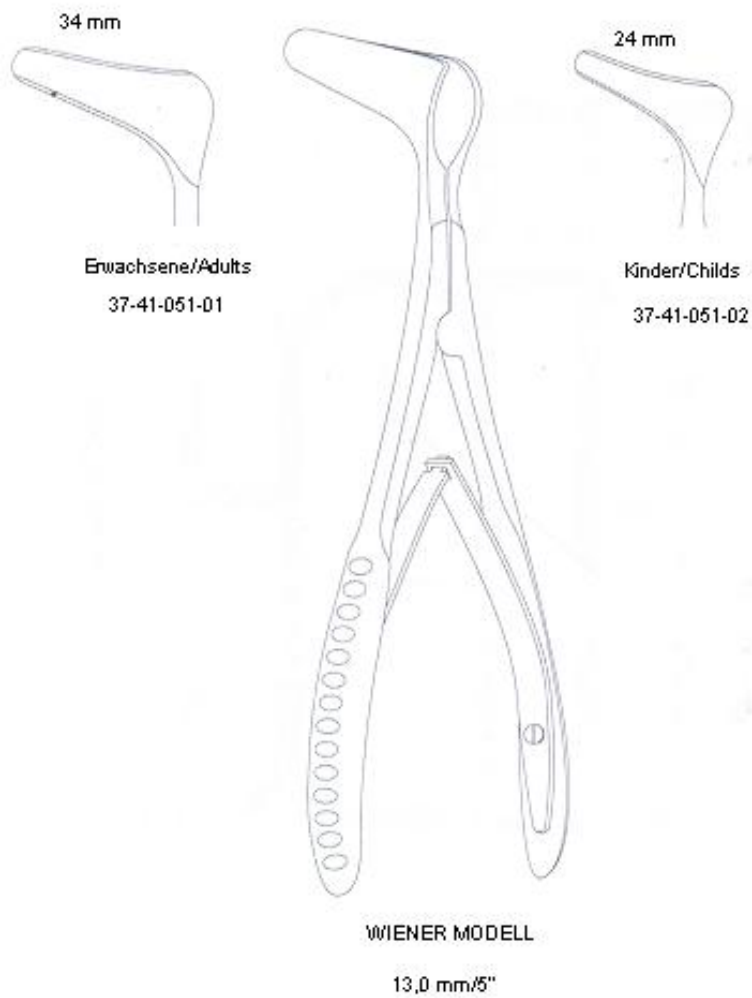

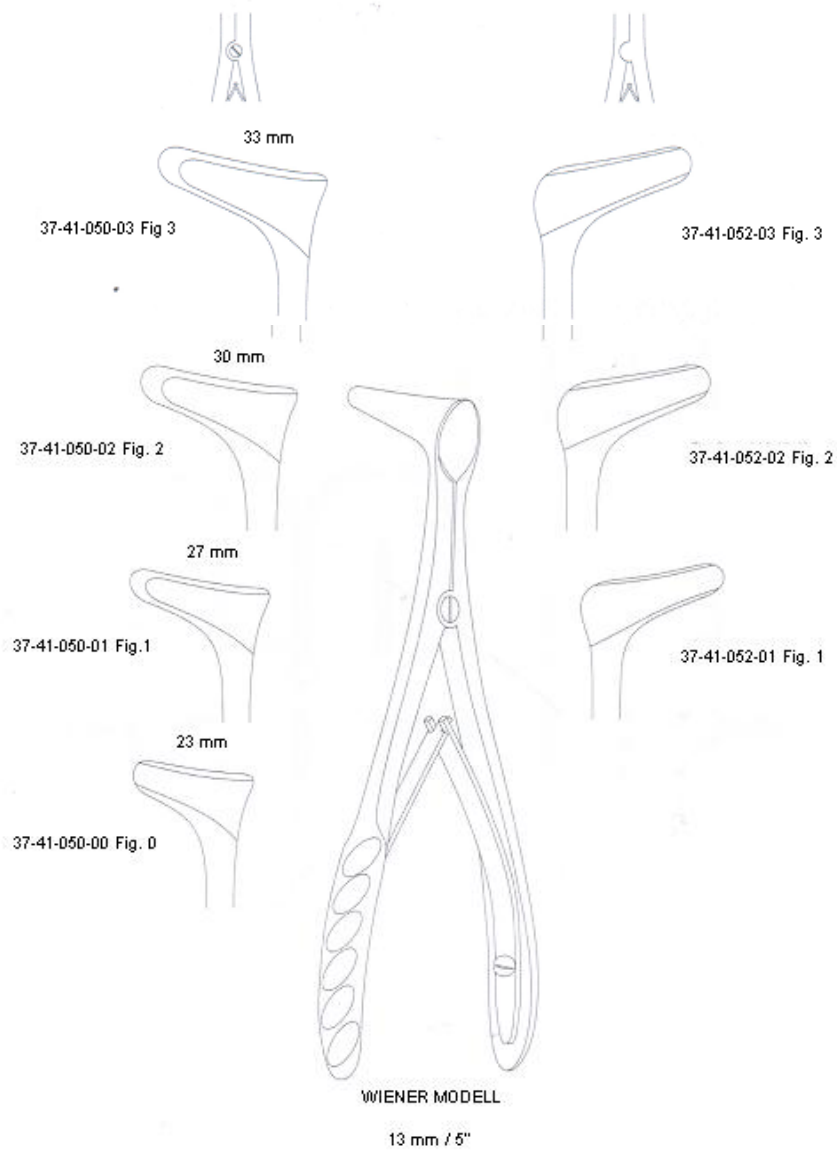

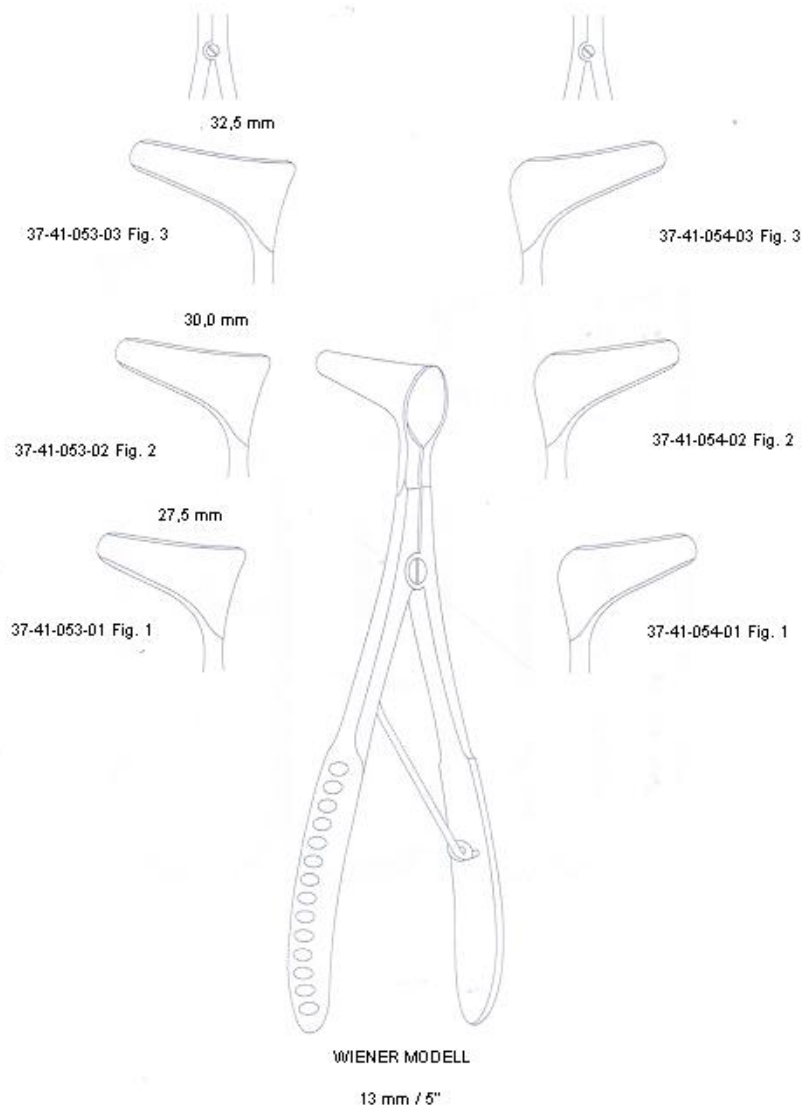

Nasal Spekula  
Nasal Spekula  
Носовые зеркала

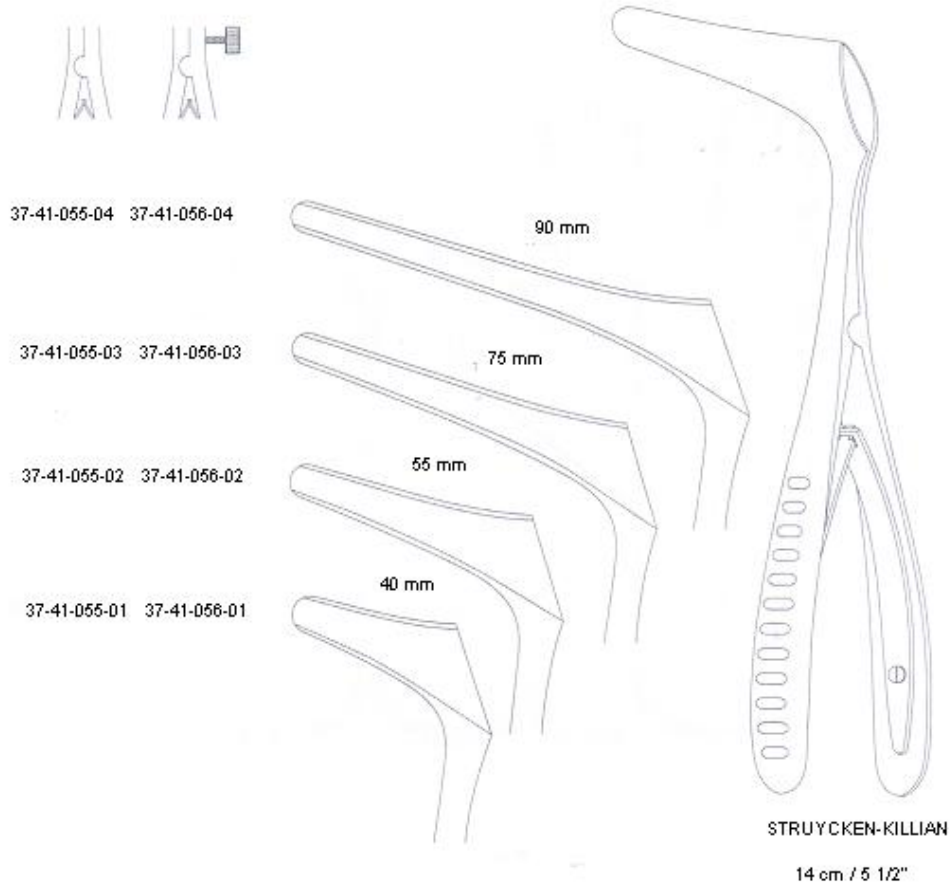

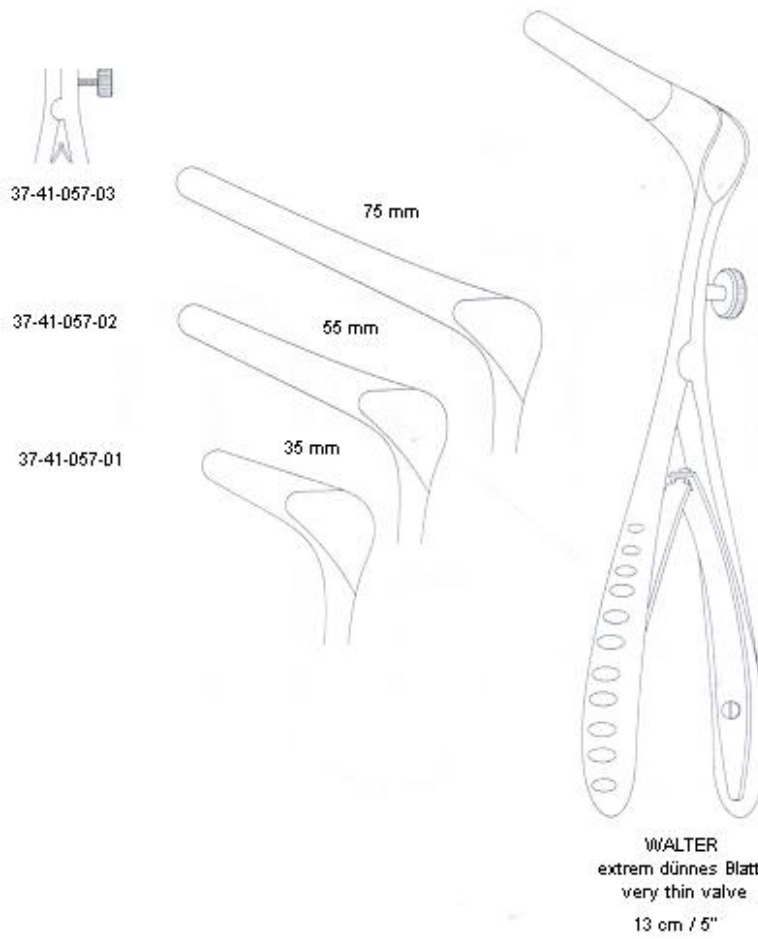



Nasal Spekula  
Nasal Spekula  
Носовые зеркала

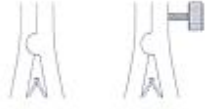

37-41-060-04 37-41-061-04

37-41-060-03 37-41-061-03

37-41-060-02 37-41-061-02

37-41-060-01 37-41-061-01

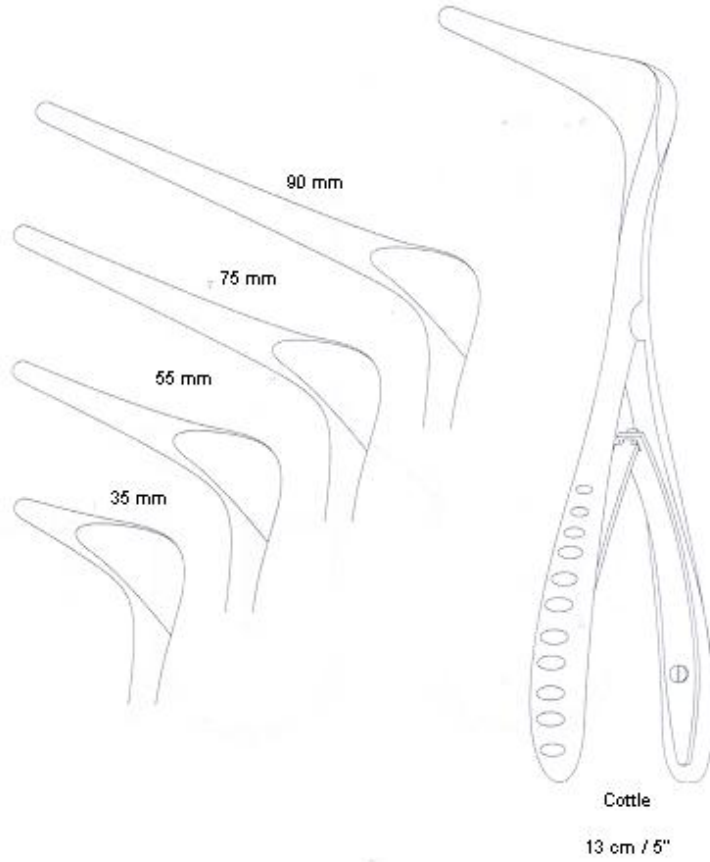

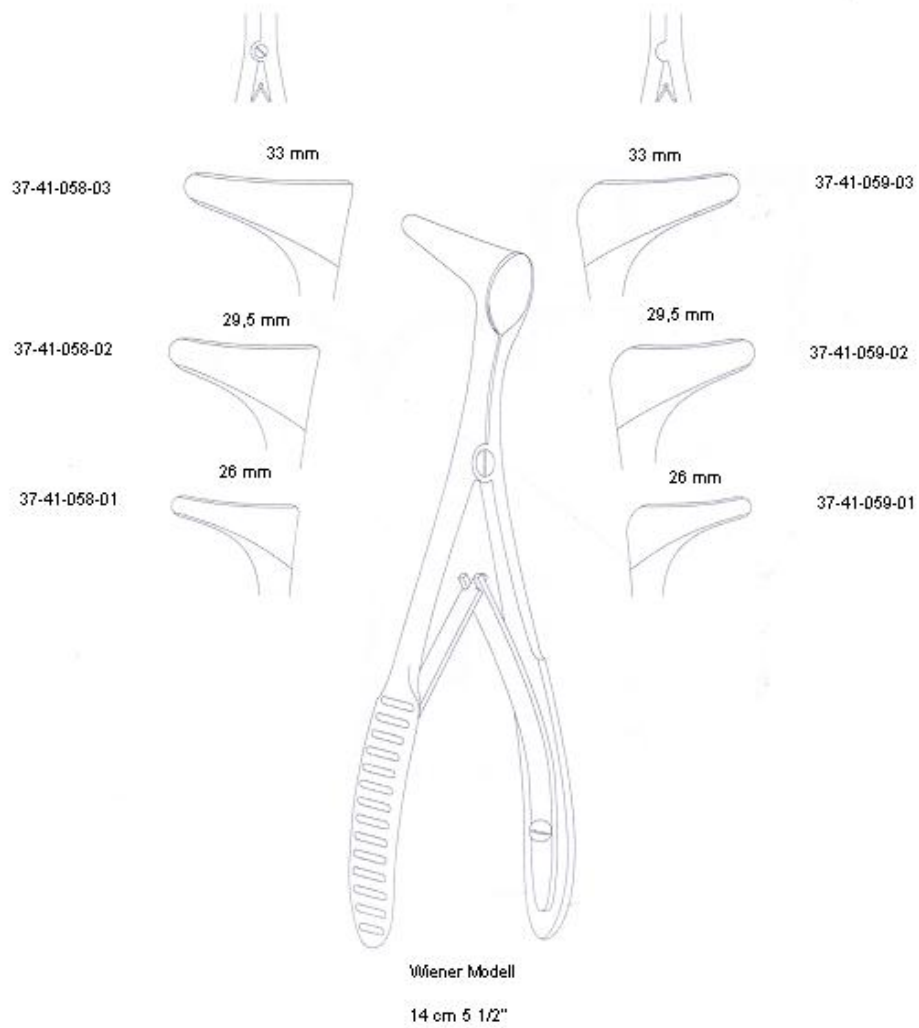

Nasal Spekula  
Nasal Spekula  
Носовые зеркала

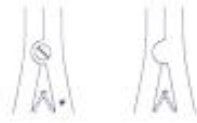

37-41-031-01

37-41-031-02



21 mm

Kinder  
Childs

37-41-030-01

37-41-030-02



17,5 mm

Säuglinge  
Babes



Halle-Tieck

13 cm5"



27 mm

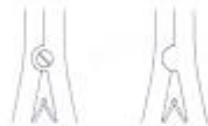

37-41-023-01 37-41-023-02



Mod. Sonnenschein  
Hartmann-Halle  
Kinder/Childs  
15cm 6"

**Knochenformzangen,  
Knochenspreizzangen  
Bone Contouring Forceps,  
Bone Enspreizzangen Expander**





Knochenformzangen, Knochenspreizzangen  
Bone Contouring Forceps, Bone Enspreizzangen Expander



**38-48-838-20**  
ohne Sperre  
without ratchet  
sans serrure  
sin cremallera  
без кремальеры

**38-48-839-20**  
mit Sperre  
with ratchet  
avec serrure  
con cremallera  
с кремальерой

**SMITH**  
23,5 cm, 9¼"



**Palatumspreizer TURVEY**  
17,5 cm, 6 ¼"  
38-58-870-17



**TESSIER**  
22 cm, 8¼"  
38-58-303-22



**MARCHAC**  
17,0 cm, 8"  
38-58-450-17



**TESSIER-ROW**



Leicht  
Medizintechnik

**Laminektomiestanzen**  
**Laminectomy Punches**  
**Ронжирный интравертебральный**  
**выкусыватель**

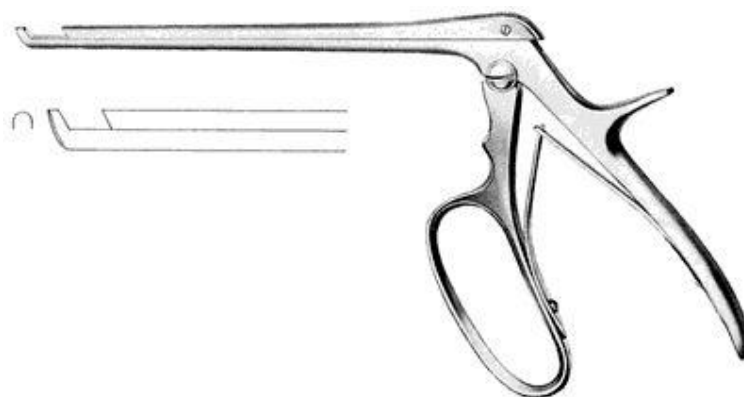
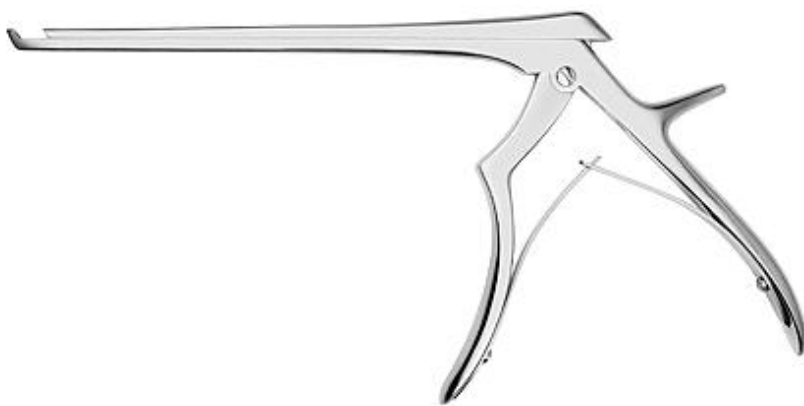





**FERRIS-SMITH-KERRISON**

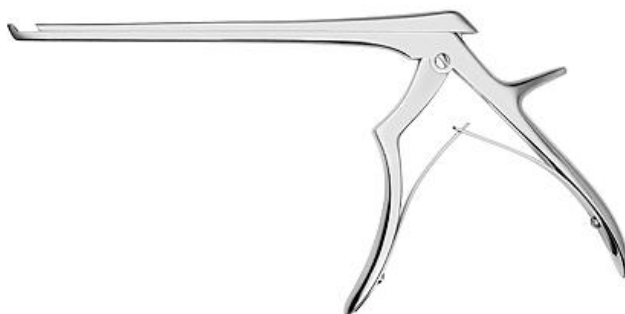

**Bandscheibenstanzen / Intervertebral Disc Rongeurs / Интравертебральный выкусыватель**

nach oben schneidend / upwards cutting / выкусывание вверх

46-71-067-01	1mm 6" 90°	46-71-067-15	4mm 8" 90°	46-71-071-14	5mm 12" 90°
46-71-067-02	1mm 7" 90°	46-71-067-16	4mm 9" 90°	46-71-071-15	5mm 13" 90°
46-71-067-03	1mm 8" 90°	46-71-067-17	5mm 6" 90°	46-71-071-16	6mm 11" 90°
46-71-067-04	1mm 9" 90°	46-71-067-18	5mm 7" 90°	46-71-071-17	6mm 12" 90°
46-71-067-05	2mm 6" 90°	46-71-067-19	5mm 8" 90°	46-71-071-18	6mm 13" 90°
46-71-067-06	2mm 7" 90°	46-71-067-20	5mm 9" 90°	46-71-067-22	6mm 7" 90°
46-71-067-07	2mm 8" 90°	46-71-067-21	6mm 6" 90°	46-71-067-23	6mm 8" 90°
46-71-067-08	2mm 9" 90°	46-71-071-07	3mm 11" 90°	46-71-067-24	6mm 9" 90°
46-71-067-09	3mm 6" 90°	46-71-071-08	3mm 12" 90°	46-71-071-01	1mm 11" 90°
46-71-067-10	3mm 7" 90°	46-71-071-09	3mm 13" 90°	46-71-071-02	1mm 12" 90°
46-71-067-11	3mm 8" 90°	46-71-071-10	4mm 11" 90°	46-71-071-03	1mm 13" 90°
46-71-067-12	3mm 9" 90°	46-71-071-11	4mm 12" 90°	46-71-071-04	2mm 11" 90°
46-71-067-13	4mm 6" 90°	46-71-071-12	4mm 13" 90°	46-71-071-05	2mm 12" 90°
46-71-067-14	4mm 7" 90°	46-71-071-13	5mm 11" 90°	46-71-071-06	2mm 13" 90°

nach unten schneidend / downwards / выкусывание вниз

46-71-073-01	1mm 11" 90°	46-71-073-07	3mm 11" 90°	46-71-073-13	5mm 11" 90°
46-71-073-02	1mm 12" 90°	46-71-073-08	3mm 12" 90°	46-71-073-14	5mm 12" 90°
46-71-073-03	1mm 13" 90°	46-71-073-09	3mm 13" 90°	46-71-073-15	5mm 13" 90°
46-71-073-04	2mm 11" 90°	46-71-073-10	4mm 11" 90°	46-71-073-16	6mm 11" 90°
46-71-073-05	2mm 12" 90°	46-71-073-11	4mm 12" 90°	46-71-073-17	6mm 12" 90°
46-71-073-06	2mm 13" 90°	46-71-073-12	4mm 13" 90°	46-71-073-18	6mm 13" 90°

## FERRIS-SMITH-KERRISON

### Bandscheibenstanzen / Intervertebral Disc Rongeurs / Интравертебральный выкусыватель

nach oben schneidend / upwards cutting / выкусывание наверх

46-71-069-01	1mm 6" 40°	46-71-069-17	4mm 7" 40°	46-71-072-03	1mm 13" 40°
46-71-069-02	1mm 7" 40°	46-71-069-18	4mm 8" 40°	46-71-072-04	2mm 11" 40°
46-71-069-03	1mm 8" 40°	46-71-069-19	4mm 9" 40°	46-71-072-05	2mm 12" 40°
46-71-069-04	1mm 9" 40°	46-71-069-20	4mm 10" 40°	46-71-072-06	2mm 13" 40°
46-71-069-05	1mm 10" 40°	46-71-069-21	5mm 6" 40°	46-71-072-07	3mm 11" 40°
46-71-069-06	2mm 6" 40°	46-71-069-22	5mm 7" 40°	46-71-072-08	3mm 12" 40°
46-71-069-07	2mm 7" 40°	46-71-069-23	5mm 8" 40°	46-71-072-09	3mm 13" 40°
46-71-069-08	2mm 8" 40°	46-71-069-24	5mm 9" 40°	46-71-072-10	4mm 11" 40°
46-71-069-09	2mm 9" 40°	46-71-069-25	5mm 10" 40°	46-71-072-11	4mm 12" 40°
46-71-069-10	2mm 10" 40°	46-71-069-26	6mm 6" 40°	46-71-072-12	4mm 13" 40°
46-71-069-11	3mm 6" 40°	46-71-069-27	6mm 7" 40°	46-71-072-13	5mm 11" 40°
46-71-069-12	3mm 7" 40°	46-71-069-28	6mm 8" 40°	46-71-072-14	5mm 12" 40°
46-71-069-13	3mm 8" 40°	46-71-069-29	6mm 9" 40°	46-71-072-15	5mm 13" 40°
46-71-069-14	3mm 9" 40°	46-71-069-30	6mm 10" 40°	46-71-072-16	6mm 11" 40°
46-71-069-15	3mm 10" 40°	46-71-072-01	1mm 11" 40°	46-71-072-17	6mm 12" 40°
46-71-069-16	4mm 6" 40°	46-71-072-02	1mm 12" 40°	46-71-072-18	6mm 13" 40°

nach unten schneidend / downwards / выкусывание вниз

46-71-070-01	1mm 7° 40°	46-71-070-11	6mm 7° 40°	46-71-074-09	3mm 13" 40°
46-71-070-02	1mm 8° 40°	46-71-070-12	6mm 8° 40°	46-71-074-10	4mm 11" 40°
46-71-070-03	2mm 7° 40°	46-71-074-01	1mm 11" 40°	46-71-074-11	4mm 12" 40°
46-71-070-04	2mm 8° 40° d	46-71-074-02	1mm 12" 40°	46-71-074-12	4mm 13" 40°
46-71-070-05	3mm 7° 40°	46-71-074-03	1mm 13" 40°	46-71-074-13	5mm 11" 40°
46-71-070-06	3mm 8° 40°	46-71-074-04	2mm 11" 40°	46-71-074-14	5mm 12" 40°
46-71-070-07	4mm 7° 40°	46-71-074-05	2mm 12" 40°	46-71-074-15	5mm 13" 40°
46-71-070-08	4mm 8° 40°	46-71-074-06	2mm 13" 40°	46-71-074-16	6mm 11" 40°
46-71-070-09	5mm 7° 40°	46-71-074-07	3mm 11" 40°	46-71-074-17	6mm 12" 40°
46-71-070-10	5mm 8° 40°	46-71-074-08	3mm 12" 40°	46-71-074-18	6mm 13" 40°

Länge des Schafts / Length of shaft / Длина рабочей части				
135 mm (5")	150mm (6")	180mm (7")	200mm (8")	230mm (9")

**PLATTFUSS**



**Ferris Smith Kerrison With Thin Footplate / mit dünner Fussplatte**

nach oben schneidend / upwards cutting / выкусывание навёрх

<b>46-71-075-01</b>	1mm 7" 90°	<b>46-71-075-12</b>	4mm 9" 90°	<b>46-71-076-11</b>	3mm 7" 40°
<b>46-71-075-02</b>	1mm 8" 90°	<b>46-71-076-01</b>	5mm 7" 90°	<b>46-71-076-12</b>	3mm 8" 40°
<b>46-71-075-03</b>	1mm 9" 90°	<b>46-71-076-02</b>	5mm 8" 90°	<b>46-71-076-13</b>	3mm 9" 40°
<b>46-71-075-04</b>	2mm 7" 90°	<b>46-71-076-03</b>	5mm 9" 90°	<b>46-71-076-14</b>	4mm 7" 40°
<b>46-71-075-05</b>	2mm 8" 90°	<b>46-71-076-04</b>	6mm 9" 90°	<b>46-71-076-15</b>	4mm 7" 40°
<b>46-71-075-06</b>	2mm 9" 90°	<b>46-71-076-05</b>	1mm 7" 40°	<b>46-71-076-16</b>	4mm 8" 40°
<b>46-71-075-07</b>	3mm 7" 90°	<b>46-71-076-06</b>	1mm 8" 40°	<b>46-71-076-17</b>	5mm 7" 40°
<b>46-71-075-08</b>	3mm 8" 90°	<b>46-71-076-07</b>	1mm 9" 40°	<b>46-71-076-18</b>	5mm 8" 40°
<b>46-71-075-09</b>	3mm 9" 90°	<b>46-71-076-08</b>	2mm 7" 40°	<b>46-71-076-19</b>	5mm 9" 40°
<b>46-71-075-10</b>	4mm 7" 90°	<b>46-71-076-09</b>	2mm 8" 40°	<b>46-71-076-20</b>	6mm 9" 40°
<b>46-71-075-11</b>	4mm 8" 90°	<b>46-71-076-10</b>	2mm 8" 40°		

Laminektomiestanzen  
Laminectomy Punches  
Ронжирный интравертбральный выкусыватель

Ferris Smith-Cloward

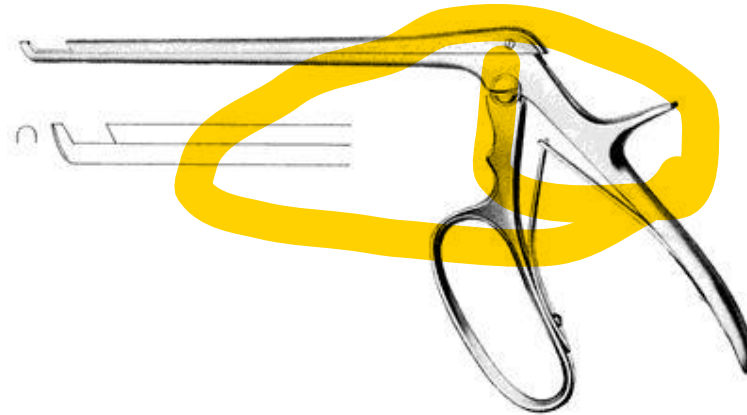

<b>46-71-078-01</b>	2x10mm gerade / straight / прямой	<b>46-71-078-10</b>	4x08mm gerade / straight прямой
<b>46-71-078-02</b>	2x10mm nach oben / upwards / наверх	<b>46-71-078-11</b>	4x08mm nach oben / upwards / наверх
<b>46-71-078-03</b>	2x10mm nach unten / down / вниз	<b>46-71-078-12</b>	4x08mm nach unten / down / вниз
<b>46-71-078-04</b>	3x10mm gerade / straight / прямой	<b>46-71-078-13</b>	6x10mm gerade / straight прямой
<b>46-71-078-05</b>	3x10mm nach oben / upwards / наверх	<b>46-71-078-14</b>	6x10mm nach oben / upwards / наверх
<b>46-71-078-06</b>	3x10mm nach unten / down / вниз	<b>46-71-078-15</b>	6x10mm nach unten / down / вниз
<b>46-71-078-07</b>	4x10mm gerade / straight прямой	<b>46-71-078-16</b>	6x12mm gerade / straight прямой
<b>46-71-078-08</b>	4x10mm nach oben / upwards / наверх	<b>46-71-078-17</b>	6x12mm nach oben / upwards / наверх
<b>46-71-078-09</b>	4x10mm nach unten / down / вниз	<b>46-71-078-18</b>	6x12mm nach unten / down / вниз

### Colclough (Richter)



mit großer Griff / große Öffnung / nach oben schneidend  
with large handle / wide opening / upwards cutting  
с большой ручкой / широкое открытие / выкусывание вверх

<b>46-71-077-01</b>	2mm 6" 90°	<b>46-71-077-11</b>	5mm 7" 90°	<b>46-71-077-21</b>	3mm 8" 40°
<b>46-71-077-02</b>	2mm 7" 90°	<b>46-71-077-12</b>	5mm 8" 90°	<b>46-71-077-22</b>	4mm 6" 40°
<b>46-71-077-03</b>	2mm 8" 90°	<b>46-71-077-13</b>	6mm 6" 90°	<b>46-71-077-23</b>	4mm 7" 40°
<b>46-71-077-04</b>	3mm 6" 90	<b>46-71-077-14</b>	6mm 7" 90°	<b>46-71-077-24</b>	4mm 8" 40°
<b>46-71-077-05</b>	3mm 7" 90°	<b>46-71-077-15</b>	6mm 8" 90°	<b>46-71-077-25</b>	5mm 6" 40°
<b>46-71-077-06</b>	3mm 8" 90°	<b>46-71-077-16</b>	2mm 6" 40°	<b>46-71-077-26</b>	5mm 7" 40°
<b>46-71-077-07</b>	4mm 6" 90°	<b>46-71-077-17</b>	2mm 7" 40°	<b>46-71-077-27</b>	5mm 8" 40°
<b>46-71-077-08</b>	4mm 7" 90°	<b>46-71-077-18</b>	2mm 8" 40°	<b>46-71-077-28</b>	6mm 6" 40°
<b>46-71-077-09</b>	4mm 8" 90°	<b>46-71-077-19</b>	3mm 6" 40°	<b>46-71-077-29</b>	6mm 7" 40°
<b>46-71-077-10</b>	5mm 6" 90°	<b>46-71-077-20</b>	3mm 7" 40°	<b>46-71-077-30</b>	6mm 8" 40°

Laminektomiestanzen  
Laminectomy Punches  
Ронжирный интравертбральный выкусыватель

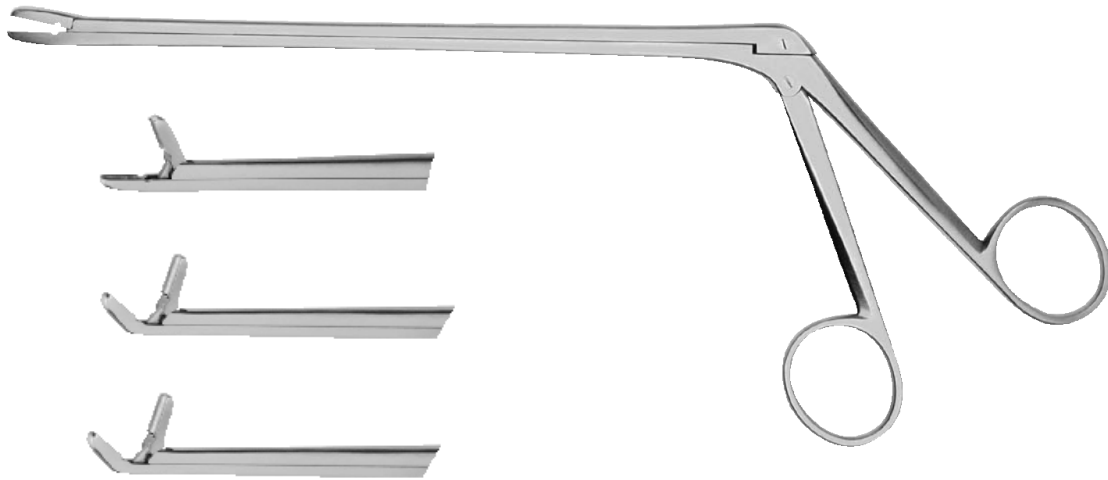

**Cushing Rongeur**

46-71-079-01	2x10mm 5" gerade / straight / прямой
46-71-079-02	2x10mm 5" nach oben / upwards / навверх
46-71-079-03	2x10mm 5" nach unten / down / вниз

46-71-079-04	2x10mm 6" gerade / straight / прямой
46-71-079-05	2x10mm 6" nach oben / upwards / навверх
46-71-079-06	2x10mm 6" nach unten / down / вниз

46-71-079-07	2x10mm 7" gerade / straight / прямой
46-71-079-08	2x10mm 7" nach oben / upwards / навверх
46-71-079-09	2x10mm 7" nach unten / down / вниз

with large handle / mit grosser Griff/ с длинной ручкой

46-71-082-01	2x10mm 7" gerade / straight / прямой
--------------	--------------------------------------

46-71-082-02	2x10mm 7" nach oben / upwards / навверх
--------------	---

46-71-082-03	2x10mm 7" nach unten / down / вниз
--------------	------------------------------------

**Love Gruenwald**

46-71-080-01	3x10mm 5" gerade / straight / прямой
46-71-080-02	3x10mm 5" nach oben / upwards / навверх
46-71-080-03	3x10mm 5" nach unten / down / вниз

46-71-080-04	3x10mm 6" gerade / straight / прямой
46-71-080-05	3x10mm 6" nach oben / upwards / навверх
46-71-080-06	3x10mm 6" nach unten / down / вниз

46-71-080-07	3x10mm 7" gerade / straight / прямой
46-71-080-08	3x10mm 7" nach oben / upwards / навверх
46-71-080-09	3x10mm 7" nach unten / down / вниз

with large handle / mit grosser Griff / с длинной ручкой

46-71-083-01	3x10mm 7" gerade / straight / прямой
--------------	--------------------------------------

46-71-083-02	3x10mm 7" nach oben / upwards / навверх
--------------	---

46-71-083-03	3x10mm 7" nach unten / down / вниз
--------------	------------------------------------

**Spurling**

46-71-081-01	4x10mm 5" gerade / straight / прямой
46-71-081-02	4x10mm 5" nach oben / upwards / навверх
46-71-081-03	4x10mm 5" nach unten / down / вниз

46-71-081-04	4x10mm 6" gerade / straight / прямой
46-71-081-05	4x10mm 6" nach oben / upwards / навверх
46-71-081-06	4x10mm 6" nach unten / down / вниз

46-71-081-07	4x10mm 7" gerade / straight / прямой
46-71-081-08	4x10mm 7" nach oben / upwards / навверх
46-71-081-09	4x10mm 7" nach unten / down / вниз

with large handle / mit grosser Griff / с длинной ручкой

46-71-084-01	4x10mm 7" gerade / straight / прямой
--------------	--------------------------------------

46-71-084-02	4x10mm 7" nach oben / upwards / навверх
--------------	---

46-71-084-03	4x10mm 7" nach unten / down / вниз
--------------	------------------------------------

# Tuttlingen

COMMITTED TO QUALITY

COMMITTED TO QUALITY

COMMITTED TO QUALITY



## Leicht Medizintechnik

LEICHT-MEDIZINTECHNIK  
OBERER BANN 60  
78532 TUTTLINGEN  
GERMANY

TEL.: 00 49 7461 910 24 96  
FAX: 00 49 7461 911 54 84  
[www.leicht-medizintechnik.de](http://www.leicht-medizintechnik.de)  
[info@leicht-medizintechnik.de](mailto:info@leicht-medizintechnik.de)

Printed in Germany. Copyright by LEICHT-MEDIZINTECHNIK  
Alle Rechte vorbehalten. Änderungen vorbehalten. We re-  
Served the right to make alterations. Combios techicos  
Reservados. Sous réserve de modifications techniques. Мы  
оставляем за собой право вносить технические изменения  
и допуски.